

C6D08065Q

6th Generation 650 V, 8 A Silicon Carbide Schottky Diode

Description

With the performance advantages of a Silicon Carbide (SiC) Schottky Barrier diode, power electronics systems can expect to meet higher efficiency standards than Si-based solutions, while also reaching higher frequencies and power densities. SiC diodes can be easily paralleled to meet various application demands, without concern of thermal runaway. In combination with the reduced cooling requirements and improved thermal performance of SiC products, SiC diodes are able to provide lower overall system costs in a variety of diverse applications.

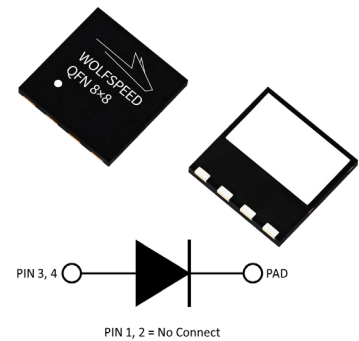

Package Types: QFN 8x8
Marking: C6D08065Q

Features

- Low Forward Voltage (V_F) Drop with Positive Temperature Coefficient
- Zero Reverse Recovery Current / Forward Recovery Voltage
- Temperature-Independent Switching Behavior
- Low Profile Package with Low Inductance

Applications

- Enterprise Power, Server, & Telecom Power Supplies
- Switched Mode Power Supplies
- Industrial Power Supplies
- Boost Power Factor Correction
- Bootstrap Diode
- LLC Clamping

Maximum Ratings ($T_c = 25^\circ\text{C}$ Unless Otherwise Specified)

Parameter	Symbol	Value	Unit	Test Conditions	Notes
Repetitive Peak Reverse Voltage	V_{RRM}	650	V		
DC Blocking Voltage	V_{DC}	650			
Continuous Forward Current	I_F	28	A	$T_J = 25^\circ\text{C}$	Fig. 3
		14		$T_J = 125^\circ\text{C}$	
		8		$T_J = 155^\circ\text{C}$	
Non-Repetitive Peak Forward Surge Current	I_{FSM}	55		$T_c = 25^\circ\text{C}, t_p = 10\text{ ms}, \text{Half Sine Wave}$	
		51		$T_c = 110^\circ\text{C}, t_p = 10\text{ ms}, \text{Half Sine Wave}$	
Power Dissipation	P_{tot}	83	W	$T_J = 25^\circ\text{C}$	Fig. 4
		36		$T_J = 110^\circ\text{C}$	
i^2t Value	$\int i^2t$	15	A^2s	$T_c = 25^\circ\text{C}, t_p = 10\text{ ms}$	
		13		$T_c = 110^\circ\text{C}, t_p = 10\text{ ms}$	



Electrical Characteristics

Parameter	Symbol	Typ.	Max.	Unit	Test Conditions	Notes
Forward Voltage	V_F	1.27	1.5	V	$I_F = 8 \text{ A}, T_j = 25 \text{ }^\circ\text{C}$	Fig. 1
		1.37	1.6		$I_F = 8 \text{ A}, T_j = 175 \text{ }^\circ\text{C}$	
Reverse Current	I_R	2	20	μA	$V_R = 650 \text{ V}, T_j = 25 \text{ }^\circ\text{C}$	Fig. 2
		15	200		$V_R = 650 \text{ V}, T_j = 175 \text{ }^\circ\text{C}$	
Total Capacitive Charge	Q_C	29		nC	$V_R = 400 \text{ V}, T_j = 25 \text{ }^\circ\text{C}$	Fig. 5
Total Capacitance	C	518		pF	$V_R = 0 \text{ V}, T_j = 25 \text{ }^\circ\text{C}, f = 1 \text{ MHz}$	Fig. 6
		56			$V_R = 200 \text{ V}, T_j = 25 \text{ }^\circ\text{C}, f = 1 \text{ MHz}$	
		45			$V_R = 400 \text{ V}, T_j = 25 \text{ }^\circ\text{C}, f = 1 \text{ MHz}$	
Capacitance Stored Energy	E_C	4.4		μJ	$V_R = 400 \text{ V}$	Fig. 7

Notes:

SiC Schottky Diodes are majority carrier devices, so there is no reverse recovery charge.

Thermal & Mechanical Characteristics

Parameter	Symbol	Value	Unit	Notes
Thermal Resistance, Junction to Case (Typ.)	$R_{\theta,JC}$	1.8	$^\circ\text{C} / \text{W}$	
Junction Temperature	T_j	-55 to +175	$^\circ\text{C}$	
Case & Storage Temperature	T_c	-55 to +150		
Maximum Processing Temperature	T_{PROC}	325		10 min max.

Electrostatic Discharge (ESD) Classifications

Parameter	Symbol	Notes
Human Body Model	HBM	Class 3B ($\geq 8000 \text{ V}$)
Charge Device Model	CDM	Class C3 ($\geq 1000 \text{ V}$)



Typical Performance

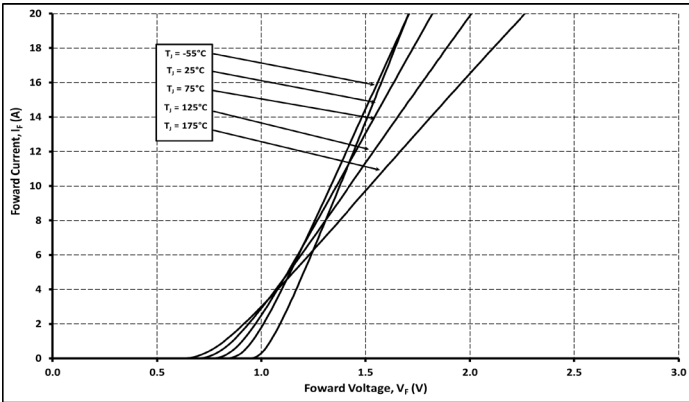

Figure 1

Forward Characteristics

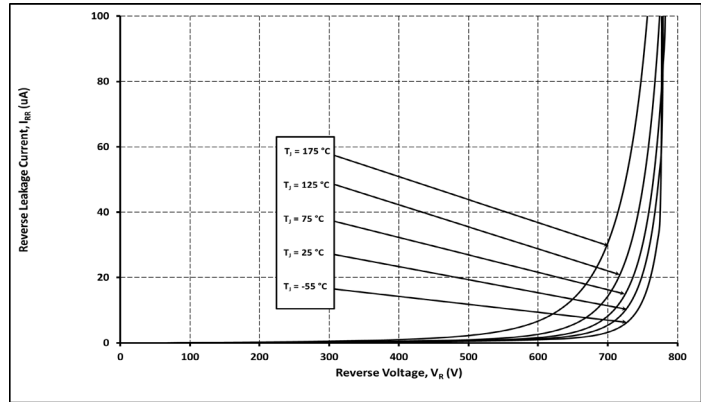

Figure 2

Reverse Characteristics

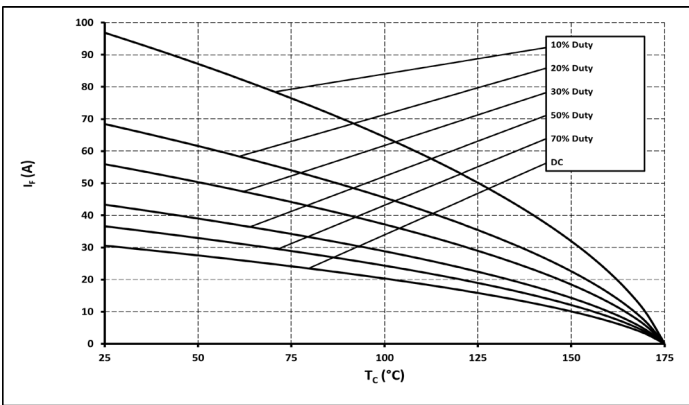

Figure 3

Current Derating

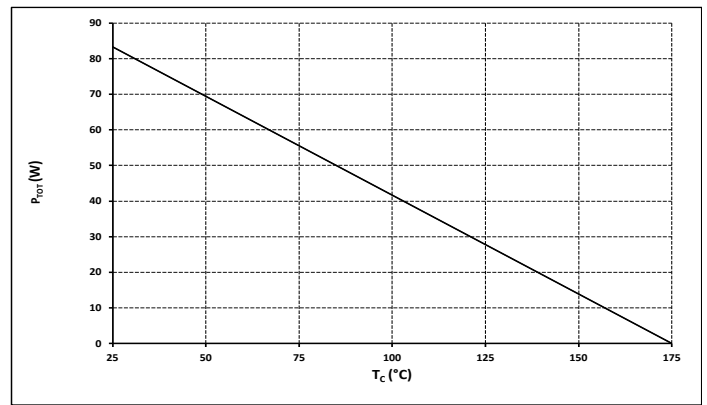

Figure 4

Power Derating

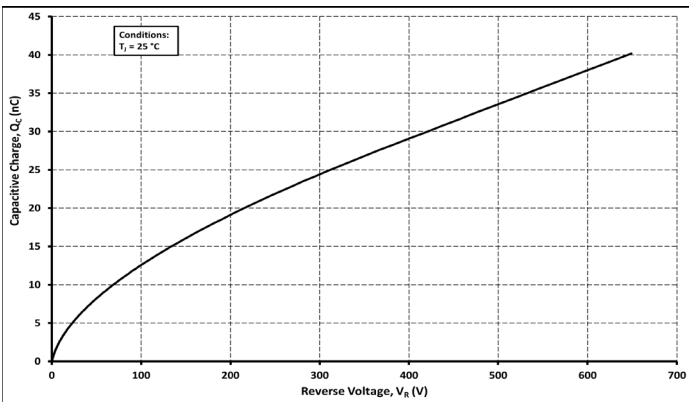

Figure 5

Total Capacitance Charge vs. Reverse Voltage

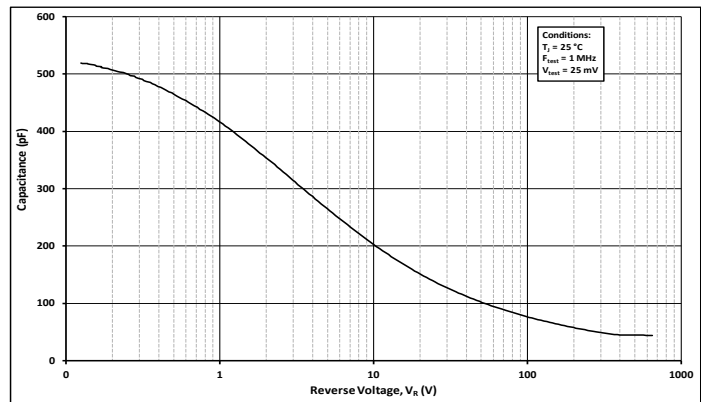

Figure 6

Capacitance vs. Reverse Voltage

Typical Performance

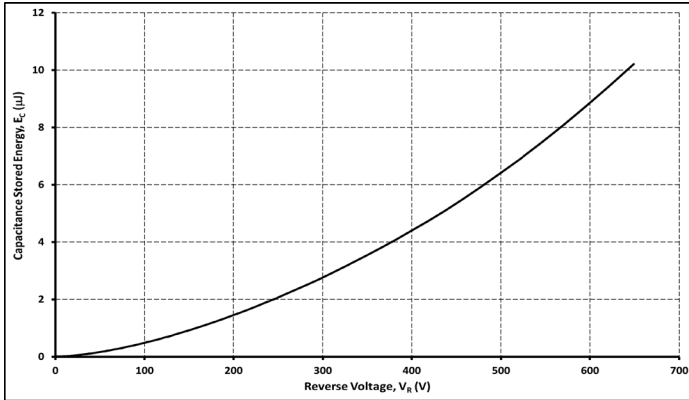

Figure 7
Capacitance Stored Energy



Package Dimensions & Pin-Out

Package: QFN 8x8

All dimensions are in mm.

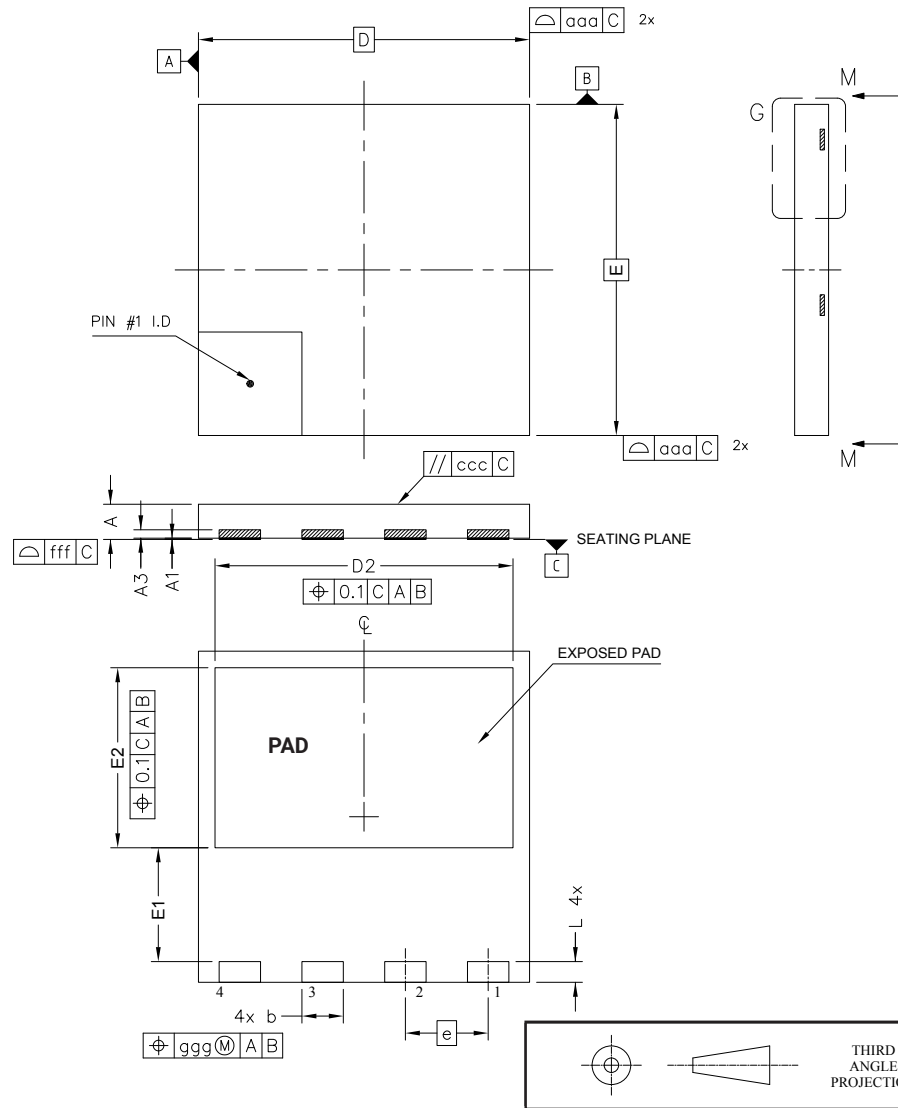

DIM	MIN	NOM	MAX
A	0.75	0.85	0.95
A1	0.00		0.05
A3	0.10	0.20	0.30
b	0.90	1.00	1.10
D	7.90	8.00	8.10
E	7.90	8.00	8.10
D2	7.10	7.20	7.30
E1	2.65	2.75	2.85
E2	4.25	4.35	4.45
e	2.00 BSC		
L	0.40	0.50	0.60
aaa	0.10		
ggg	0.05		
ccc	0.05		
fff	0.05		

Pin	Definition
1	N/C
2	N/C
3	Anode
4	Anode
PAD	Cathode



Recommended Solder Pad Layout

Learn more about recommended soldering profiles in [this application note](#).

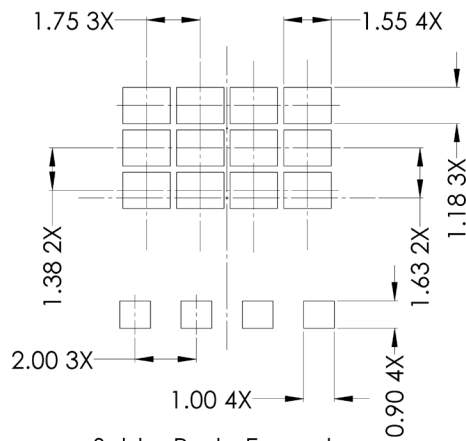

Solder Paste Example
Based on 5mil thick stencil
70% printed solder coverage by thermal pad area

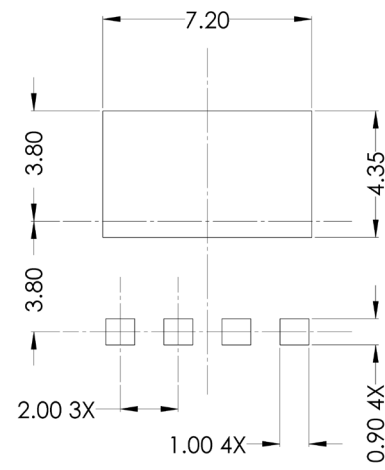

QFN 8x8 Land Pattern

Product Ordering Information

Order Number	Packing Type
C6D08065Q-TR	Tape & Reel

Learn more about power device packing & shipment information in [this application note](#).

REACH, RoHS, and Halogen-Free compliance documentation available for this product.



Notes & Disclaimer

This document and the information contained herein are subject to change without notice. Any such change shall be evidenced by the publication of an updated version of this document by Wolfspeed. No communication from any employee or agent of Wolfspeed or any third party shall effect an amendment or modification of this document. No responsibility is assumed by Wolfspeed for any infringement of patents or other rights of third parties which may result from use of the information contained herein. No license is granted by implication or otherwise under any patent or patent rights of Wolfspeed.

Notwithstanding any application-specific information, guidance, assistance, or support that Wolfspeed may provide, the buyer of this product is solely responsible for determining the suitability of this product for the buyer's purposes, including without limitation for use in the applications identified in the next bullet point, and for the compliance of the buyers' products, including those that incorporate this product, with all applicable legal, regulatory, and safety-related requirements.

This product has not been designed or tested for use in, and is not intended for use in, applications in which failure of the product would reasonably be expected to cause death, personal injury, or property damage, including but not limited to equipment implanted into the human body, life-support machines, cardiac defibrillators, and similar emergency medical equipment, aircraft navigation, communication, and control systems, aircraft power and propulsion systems, air traffic control systems, and equipment used in the planning, construction, maintenance, or operation of nuclear facilities.

RoHS Compliance

The levels of RoHS restricted materials in this product are below the maximum concentration values (also referred to as the threshold limits) permitted for such substances, or are used in an exempted application, in accordance with EU Directive 2011/65/EC (RoHS2), as implemented January 2, 2013. RoHS Declarations for this product can be obtained from your Wolfspeed representative or from the Product Documentation sections of www.wolfspeed.com.

REACH Compliance

REACH substances of high concern (SVHCs) information is available for this product. Since the European Chemical Agency (ECHA) has published notice of their intent to frequently revise the SVHC listing for the foreseeable future, please contact your Wolfspeed representative to ensure you get the most up-to-date REACH SVHC Declaration. REACH banned substance information (REACH Article 67) is also available upon request.

Contact info:

4600 Silicon Drive
Durham, NC 27703 USA
Tel: +1.919.313.5300
www.wolfspeed.com/power