

# E4MS009120QT

## Automotive Silicon Carbide Power MOSFET



### Features

- Industry compatible drive voltage 15 V ...18 V/-4 V ...0 V
- Low  $R_{DS(on)}$  at high operating temperatures
- Improved device capacitance ratio ( $C_{iss}/C_{rss}$ )
- Halogen free, RoHS compliant
- Automotive Qualified (AEC-Q101) and PPAP Capable

### Benefits

- Higher efficiency with lower switching losses and EMI
- Faster switching operation enabling high power density
- Enables system level price performance optimization
- Reduction in system level cooling requirements

### Typical Applications

- Onboard charger
- High voltage DC/DC converters
- HVAC compressors
- Battery management systems

### Package

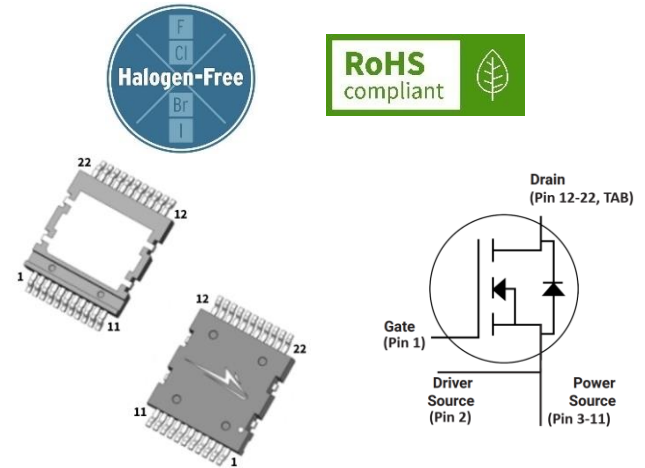

Orderable Part Number	Package Type	Marking
E4MS009120QT-TR	Q-TSC	E4MS009120QT

### Absolute Maximum Ratings

Stress beyond those listed under absolute maximum ratings may damage the device.

Symbol	Parameter	Min.	Max.	Unit	Conditions	Note
$V_{DS(max)}$	Drain-Source Voltage		1200	V		
$V_{GS(max)}$	Maximum Gate – Source Voltage (Transient)	-10	+23			Note 1
$I_D$	DC Continuous Drain Current		213	A	$V_{GS} = 18\text{ V}, T_c = 25\text{ }^\circ\text{C}, T_J \leq 175\text{ }^\circ\text{C}$	Note 2
			152		$V_{GS} = 18\text{ V}, T_c = 100\text{ }^\circ\text{C}, T_J \leq 175\text{ }^\circ\text{C}$	
$I_{DM}$	Pulsed Drain Current		700		$V_{GS} = 18\text{ V}, T_c = 25\text{ }^\circ\text{C}, t_{pmax}$ limited by $T_{Jmax}$	
$P_D$	Power Dissipation		789	W	$T_c = 25\text{ }^\circ\text{C}, T_J = 175\text{ }^\circ\text{C}$	Note 3
$T_J, T_{stg}$	Operating Junction and Storage Temperature	-55	+175	$^\circ\text{C}$		
$T_L$	Solder Temperature		260		According to JEDEC J-STD-020	

Note (1): Refer to AN PRD-09634

Note (2): Current limit calculated by  $I_{D(max)} = \sqrt{(P_D / R_{DS(typ)}(T_{J(max)}, I_{D(max)}))}$

Note (3):  $P_D = (T_J - T_c) / R_{th(JC, Max)}$



## Electrical Characteristics ( $T_c = 25\text{ }^\circ\text{C}$ unless otherwise specified)

Symbol	Parameter	Min.	Typ.	Max.	Unit	Test Conditions	Note
$V_{(BR)DSS}$	Drain – Source Breakdown Voltage	1200			V	$V_{GS} = 0\text{ V}$ , $I_D = 100\text{ }\mu\text{A}$	
$V_{GS(th)}$	Gate Threshold Voltage	2.0	2.6	3.9	V	$V_{DS} = V_{GS}$ , $I_D = 30.8\text{ mA}$	Fig. 11, Note 1
			2.0		V	$V_{DS} = V_{GS}$ , $I_D = 30.8\text{ mA}$ , $T_J = 175\text{ }^\circ\text{C}$	
$I_{DSS}$	Zero Gate Voltage Drain Current		1	50	$\mu\text{A}$	$V_{DS} = 1200\text{ V}$ , $V_{GS} = 0\text{ V}$	
$I_{GSS}$	Gate-Source Leakage Current		10	250	nA	$V_{GS} = 18\text{ V}$ , $V_{DS} = 0\text{ V}$	
$V_{GS(op)}$	Recommended Turn on Gate-Source Voltage		+15...+18		V		Note 4
	Recommended Turn off Gate-Source Voltage		-4...0				
$R_{DS(on)}$	Drain-Source On-State Resistance		9	11.7	m $\Omega$	$V_{GS} = 18\text{ V}$ , $I_D = 100\text{ A}$	Fig. 4, 5, 6
			16.9			$V_{GS} = 18\text{ V}$ , $I_D = 100\text{ A}$ , $T_J = 175\text{ }^\circ\text{C}$	
			10.3			$V_{GS} = 15\text{ V}$ , $I_D = 100\text{ A}$	
$g_{fs}$	Transconductance		77		S	$V_{DS} = 20\text{ V}$ , $I_D = 100\text{ A}$	Fig. 7
			75			$V_{DS} = 20\text{ V}$ , $I_D = 100\text{ A}$ , $T_J = 175\text{ }^\circ\text{C}$	
$R_{DS(on)Tempco}$	On Resistance Temperature Coefficient		1.88			$V_{GS} = 18\text{ V}$ , $I_D = 100\text{ A}$	Note 5
$C_{iss}$	Input Capacitance		8585		pF	$V_{GS} = 0\text{ V}$ , $V_{DS} = 1000\text{ V}$ $f = 100\text{ kHz}$ $V_{AC} = 25\text{ mV}$	Fig. 17, 18
$C_{oss}$	Output Capacitance		267				
$C_{rss}$	Reverse Transfer Capacitance		13.6				
$C_{iss}/C_{rss}$	Capacitance Ratio		630				Note 6
$E_{oss}$	$C_{oss}$ Stored Energy		171				$\mu\text{J}$
$C_{o(er)}$	Effective Output Capacitance (Energy Related)		379.1		pF	$V_{GS} = 0\text{ V}$ , $V_{DS} = 0\text{ V} \dots 800\text{ V}$	Note 7
$C_{o(tr)}$	Effective Output Capacitance (Time Related)		629.8				
$E_{on}$	Turn-On Switching Energy (Body Diode FWD) $T_J = 25\text{ }^\circ\text{C}$ $T_J = 175\text{ }^\circ\text{C}$		1319		$\mu\text{J}$	$V_{DS} = 800\text{ V}$ , $V_{GS} = -4\text{ V} / 18\text{ V}$ , $I_D = 100\text{ A}$ , $R_{G(ext)} = 1\text{ }\Omega$ , $L_\sigma = 16.9\text{ nH}$	Fig. 25, 27, 29
			1649				
$E_{off}$	Turn-Off Switching Energy (Body Diode FWD) $T_J = 25\text{ }^\circ\text{C}$ $T_J = 175\text{ }^\circ\text{C}$		466		$\mu\text{J}$	$V_{DS} = 800\text{ V}$ , $V_{GS} = -4\text{ V} / 18\text{ V}$ , $I_D = 100\text{ A}$ , $R_{G(ext)} = 1\text{ }\Omega$ , $L_\sigma = 16.9\text{ nH}$	Fig. 25, 28, 29
			555				
$t_{d(on)}$	Turn-On Delay Time		14		ns	$V_{DS} = 800\text{ V}$ , $V_{GS} = -4\text{ V} / 18\text{ V}$ , $I_D = 100\text{ A}$ , $R_{G(ext)} = 1\text{ }\Omega$ , $L_\sigma = 16.9\text{ nH}$ Timing relative to $I_{DS}$ Inductive load	Fig. 26, 27, 29
$t_r$	Rise Time		9.5				
$t_{d(off)}$	Turn-Off Delay Time		87.6				Fig. 26, 28, 29
$t_f$	Fall Time		19.8				
$R_{G(int)}$	Internal Gate Resistance		2.4		$\Omega$	$f = 1\text{ MHz}$	
$Q_{gs}$	Gate to Source Charge		94		nC	$V_{DS} = 800\text{ V}$ , $V_{GS} = -4\text{ V} / 18\text{ V}$ $I_D = 100\text{ A}$	Fig. 12
$Q_{gd}$	Gate to Drain Charge		80				
$Q_g$	Total Gate Charge		340				

Note (4): Refer to AN PRD-08999.

Note (5):  $R_{DS(on)Tempco}$  refers to  $R_{DS(on)}$  at  $175\text{ }^\circ\text{C}$  /  $R_{DS(on)}$  at  $25\text{ }^\circ\text{C}$ . This is a E4MS 1200 V product family value.

Note (6): Capacitance ratio is a FOM for partial turn-on immunity AN PRD-06933. This is a E4MS 1200 V product family value.

Note (7):  $C_{o(er)}$ , a lumped capacitance that gives the same stored energy as  $C_{oss}$  while  $V_{DS}$  is rising from 0V to 800 V.

$C_{o(tr)}$ , a lumped capacitance that gives the same charging time as  $C_{oss}$  while  $V_{DS}$  is rising from 0V to 800 V.



### Reverse Diode Characteristics ( $T_C = 25\text{ }^\circ\text{C}$ unless otherwise specified)

Symbol	Parameter	Typ.	Max.	Unit	Test Conditions	Note
$V_{SD}$	Diode Forward Voltage	5.1		V	$V_{GS} = -4\text{ V}, I_{SD} = 56\text{ A}, T_J = 25\text{ }^\circ\text{C}$	Fig. 8, 9, 10
		4.5			$V_{GS} = -4\text{ V}, I_{SD} = 56\text{ A}, T_J = 175\text{ }^\circ\text{C}$	
$I_S$	Continuous Diode Forward Current		134	A	$V_{GS} = -4\text{ V}, T_C = 25\text{ }^\circ\text{C}$	
$I_{SM}$	Diode Pulse Current		700		$V_{GS} = -4\text{ V}$ , pulse width $t_p$ limited by $T_{jmax}$	
$t_{rr}$	Reverse Recovery Time	34.7		ns	$V_{GS} = -4\text{ V}, I_{SD} = 100\text{ A}, V_R = 800\text{ V}, T_J = 175\text{ }^\circ\text{C}, di/dt = 14033\text{ A}/\mu\text{s}$	Fig. 30
$Q_{rr}$	Reverse Recovery Charge	1923		nC		
$I_{RRM}$	Peak Reverse Recovery Current	97		A		
$E_{RR}$	Reverse Recovery Energy $T_j = 25\text{ }^\circ\text{C}$ $T_j = 175\text{ }^\circ\text{C}$	148		$\mu\text{J}$	$V_{DS} = 800\text{ V}, I_{DS} = 100\text{ A}, V_{GS} = -4\text{ V} / 18\text{ V}, R_{G(ext)} = 1\text{ }\Omega, L_G = 16.9\text{ nH}$	
		835				

### Thermal Characteristics

Symbol	Parameter	Typ.	Max.	Unit	Test Conditions	Note
$R_{\theta JC}$	Thermal Resistance from Junction to Case	0.11	0.19	$^\circ\text{C}/\text{W}$		



Typical Performance

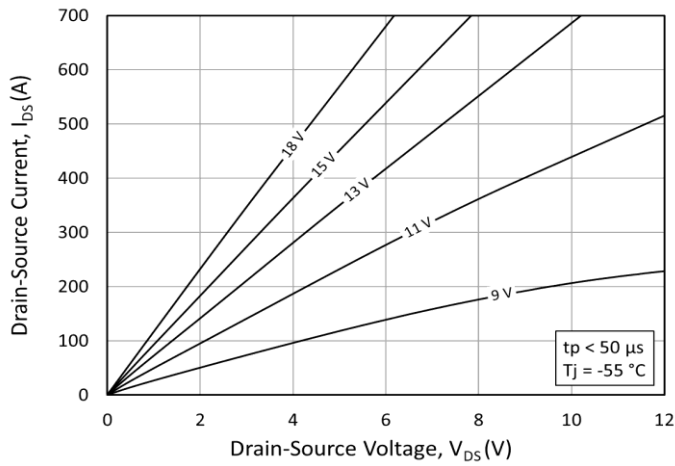

Figure 1. Output Characteristics  $T_{vj} = -55\text{ }^{\circ}\text{C}$

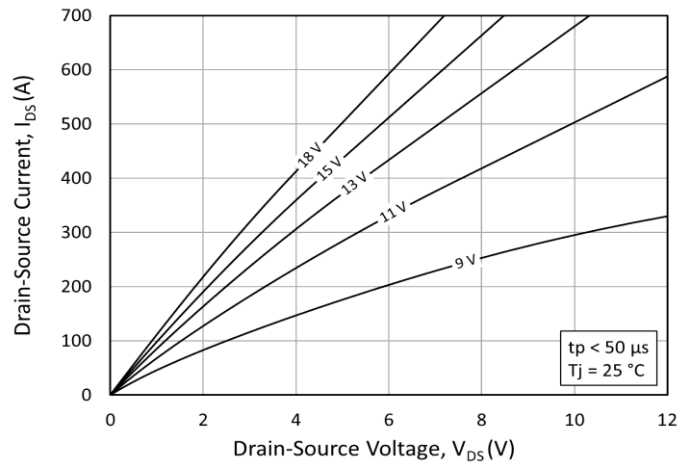

Figure 2. Output Characteristics  $T_{vj} = 25\text{ }^{\circ}\text{C}$

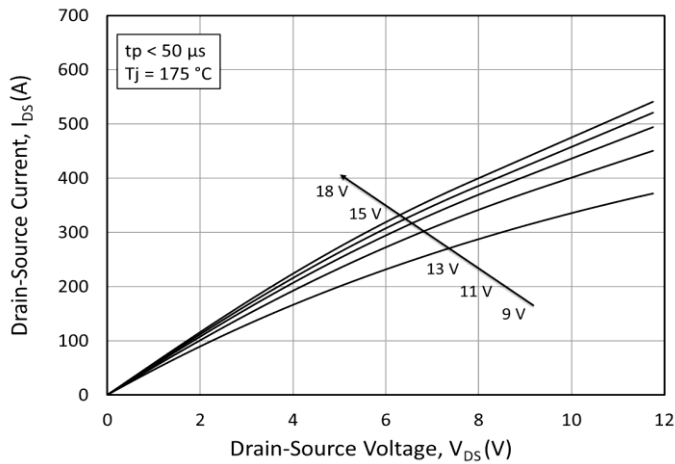

Figure 3. Output Characteristics  $T_{vj} = 175\text{ }^{\circ}\text{C}$

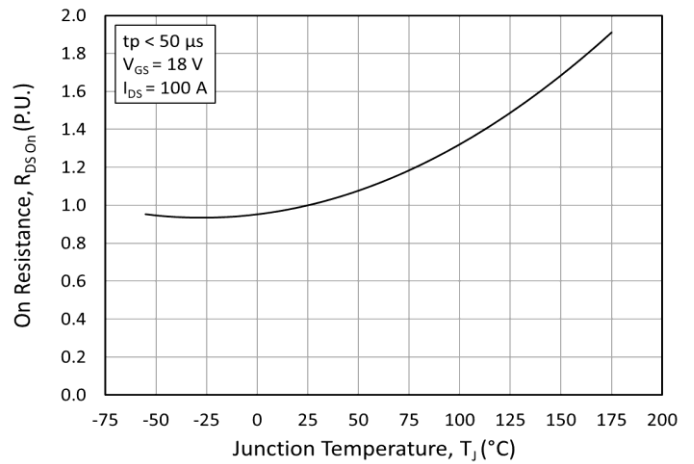

Figure 4. Normalized On-Resistance vs. Temperature

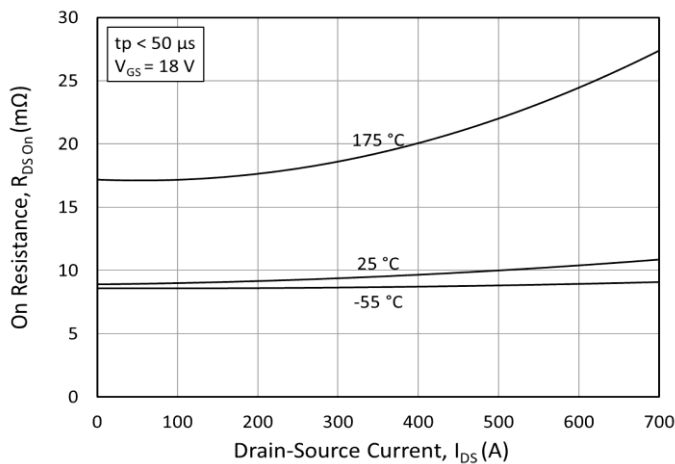

Figure 5. On-Resistance vs. Drain Current for Various Temperatures

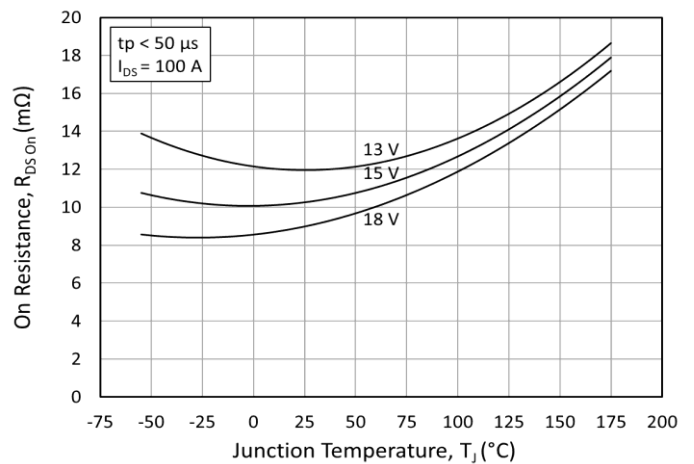

Figure 6. On-Resistance vs. Temperature for Various Gate Voltages



Typical Performance

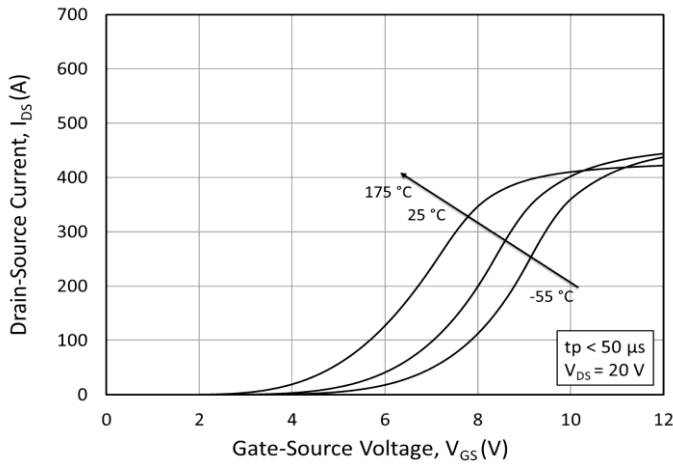

Figure 7. Transfer Characteristic for Various Junction Temperatures

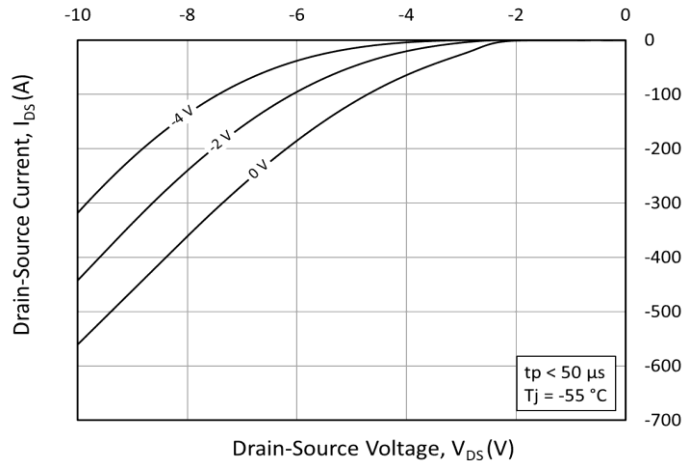

Figure 8. Body Diode Characteristic at  $T_{VJ} = -55\text{ °C}$

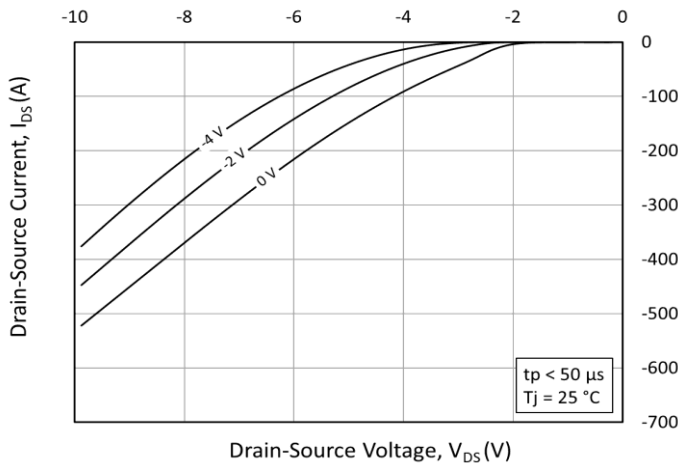

Figure 9. Body Diode Characteristic at  $T_{VJ} = 25\text{ °C}$

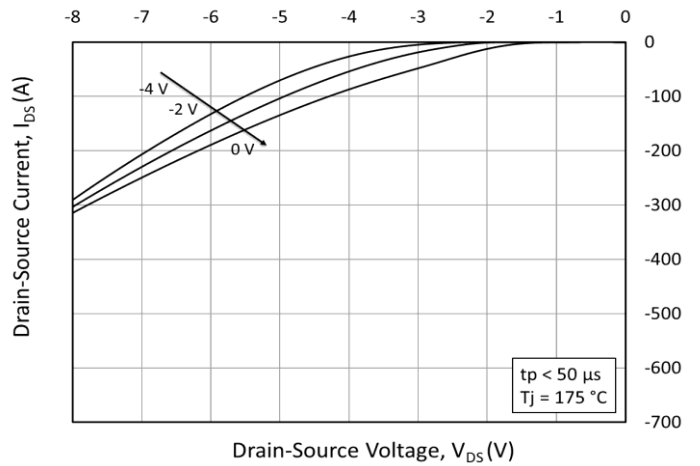

Figure 10. Body Diode Characteristic at  $T_{VJ} = 175\text{ °C}$

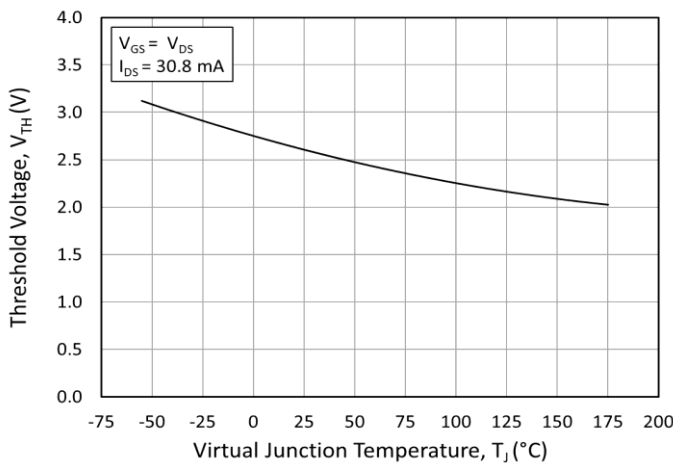

Figure 11. Threshold Voltage vs. Temperature

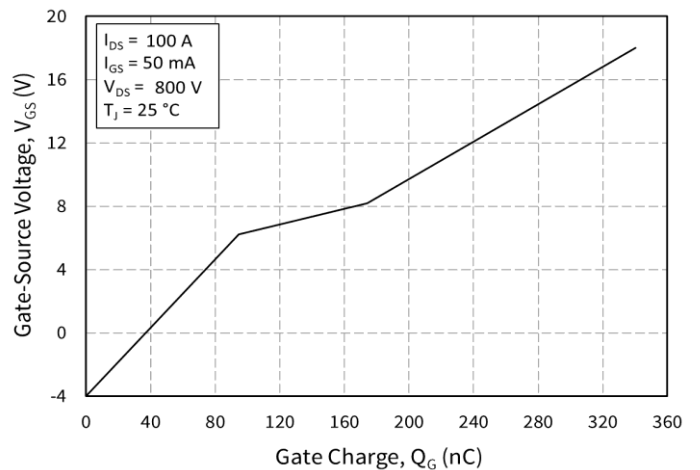

Figure 12. Gate Charge Characteristics

Typical Performance

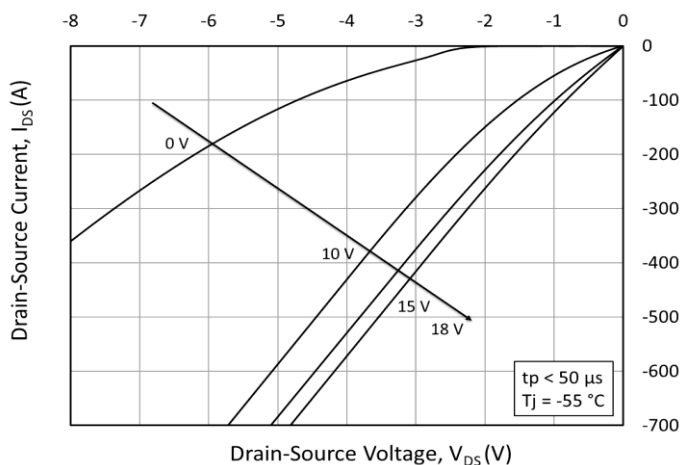

Figure 13. 3rd Quadrant Characteristic at  $T_{VJ} = -55\text{ }^{\circ}\text{C}$

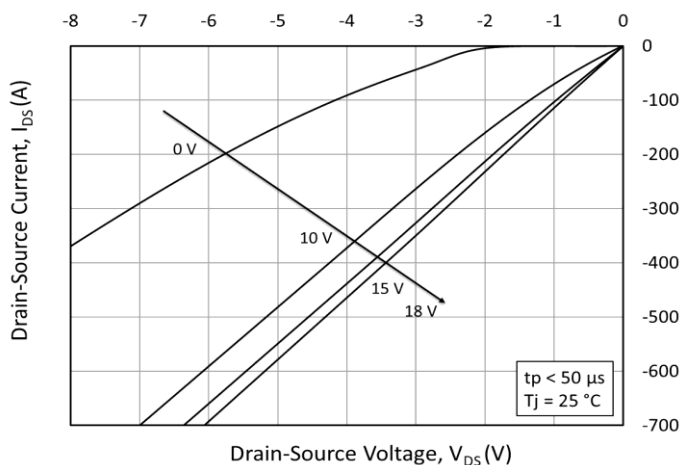

Figure 14. 3rd Quadrant Characteristic at  $T_{VJ} = 25\text{ }^{\circ}\text{C}$

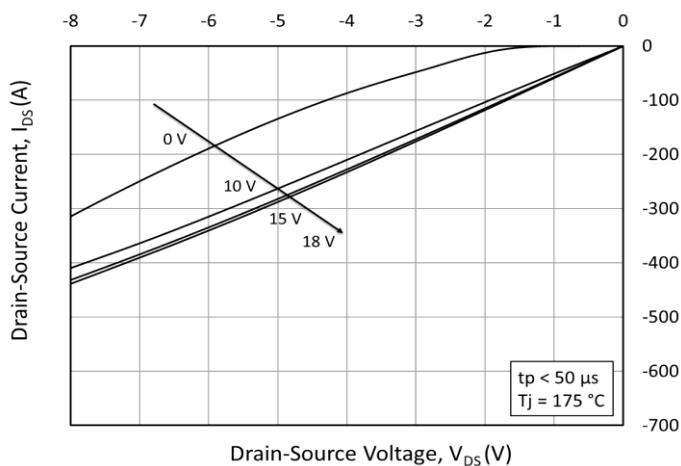

Figure 15. 3rd Quadrant Characteristic at  $T_{VJ} = 175\text{ }^{\circ}\text{C}$

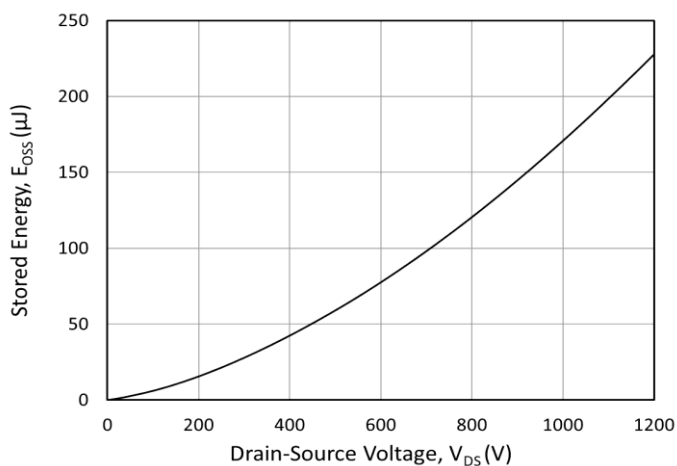

Figure 16. Output Capacitor Stored Energy

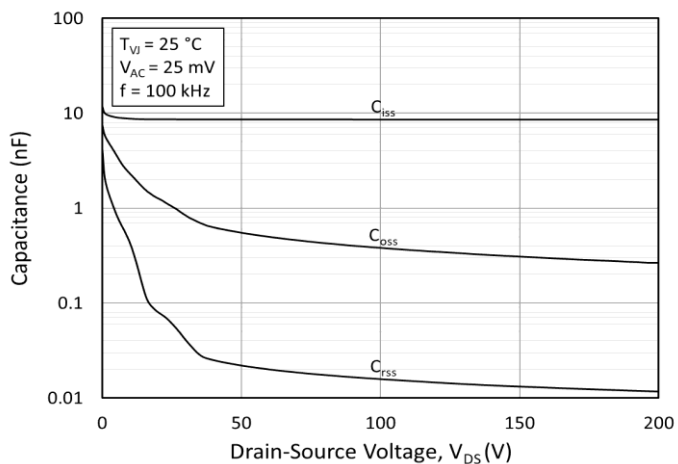

Figure 17. Capacitances vs. Drain-Source Voltage (0-200 V)

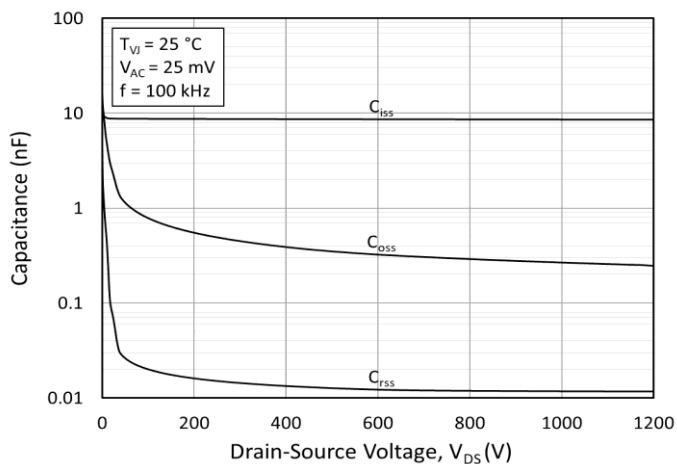

Figure 18. Capacitances vs. Drain-Source Voltage (0-1200 V)



Typical Performance

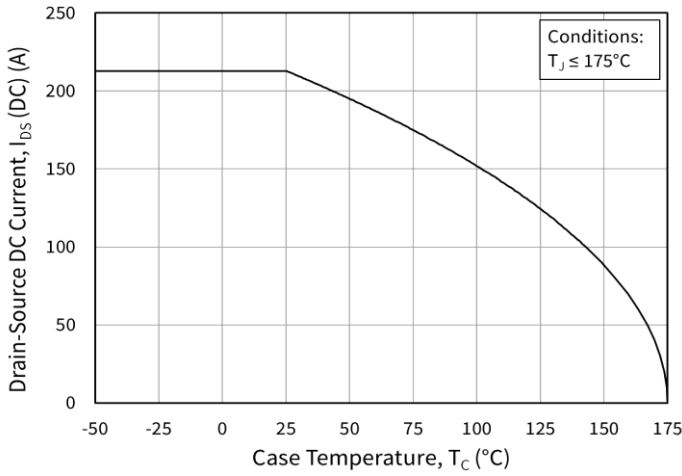

Figure 19. Continuous Drain Current Derating vs. Case Temperature

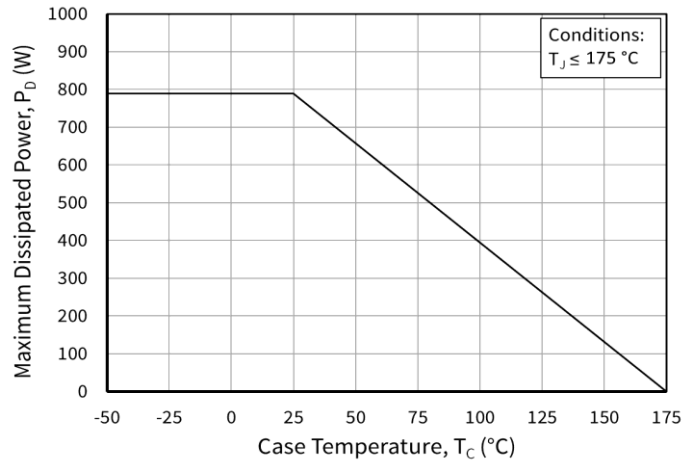

Figure 20. Maximum Power Dissipation Derating vs. Case Temperature

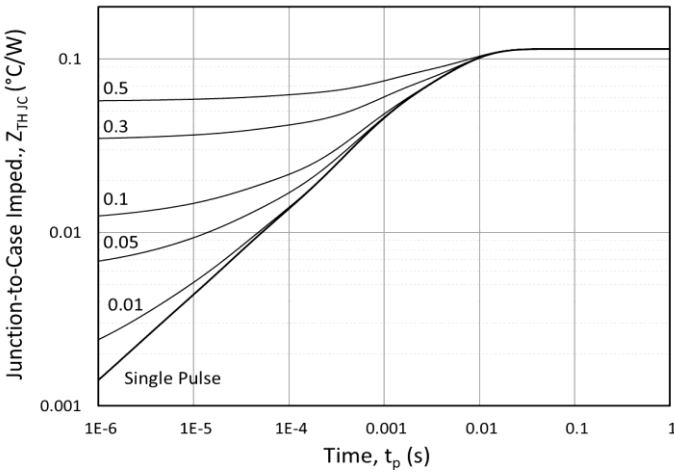

Figure 21. Transient Thermal Impedance (Junction - Case) °C/W

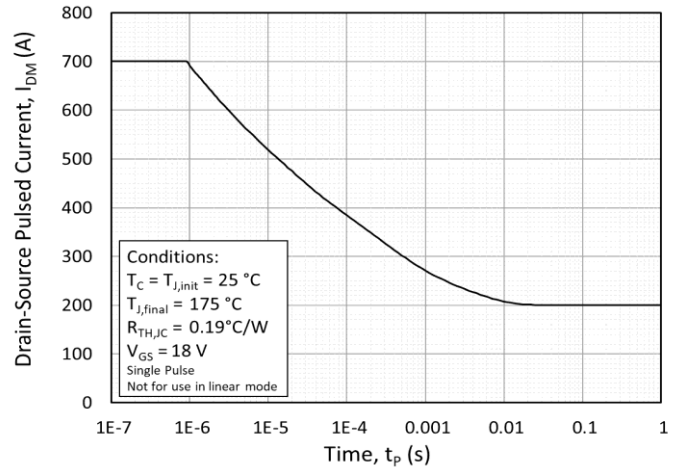

Figure 22. Safe Operating Area

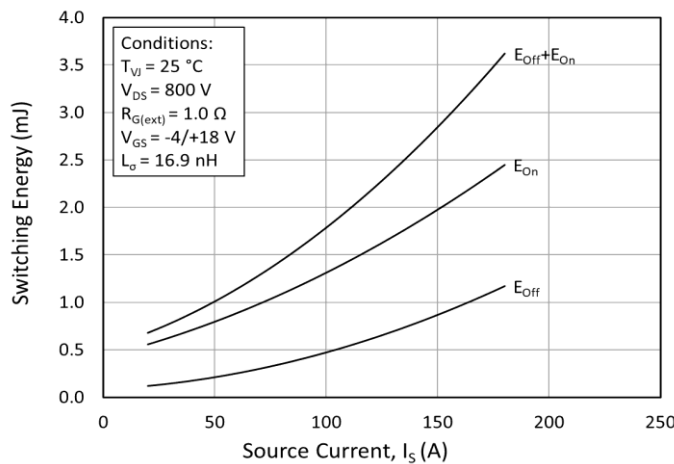

Figure 23. Clamped Inductive Switching Energy vs. Drain Current ( $V_{DD} = 800\text{ V}$ )

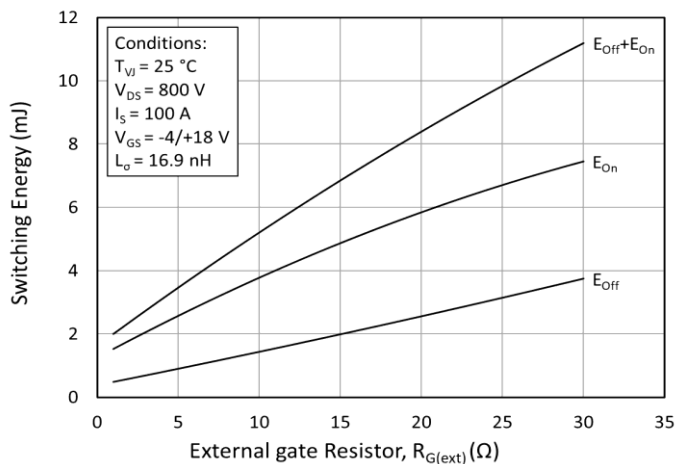

Figure 24. Clamped Inductive Switching Energy vs.  $R_{G(ext)}$

Typical Performance

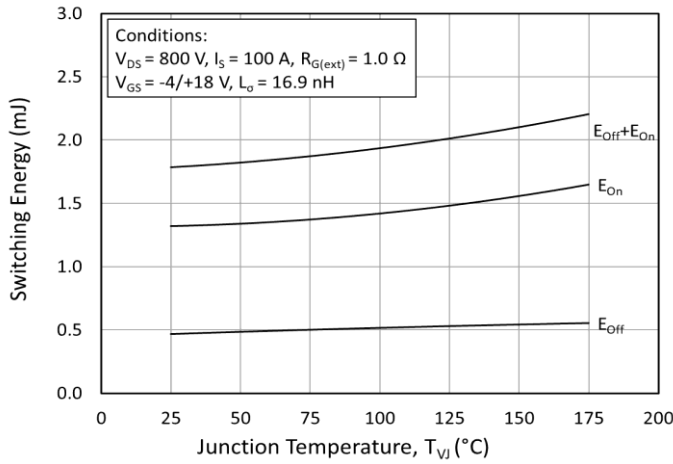

Figure 25. Clamped Inductive Switching Energy vs. Temperature

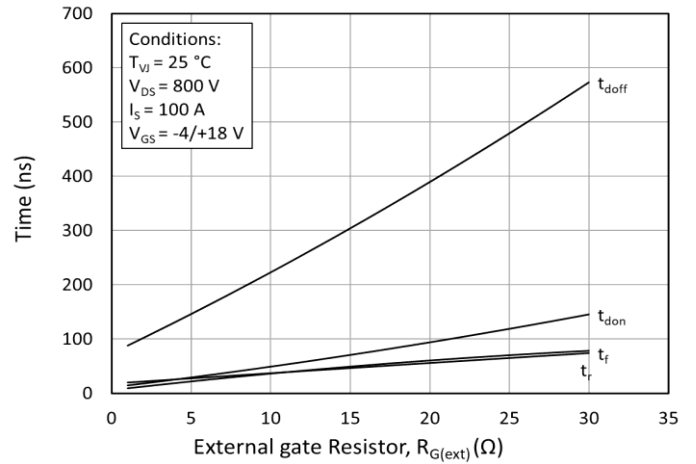

Figure 26. Switching Times vs.  $R_{G(ext)}$

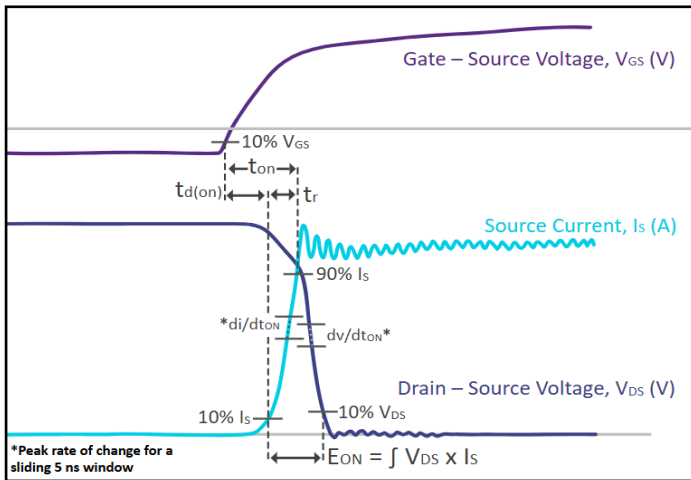

Figure 27. Turn On Switching Time Definition

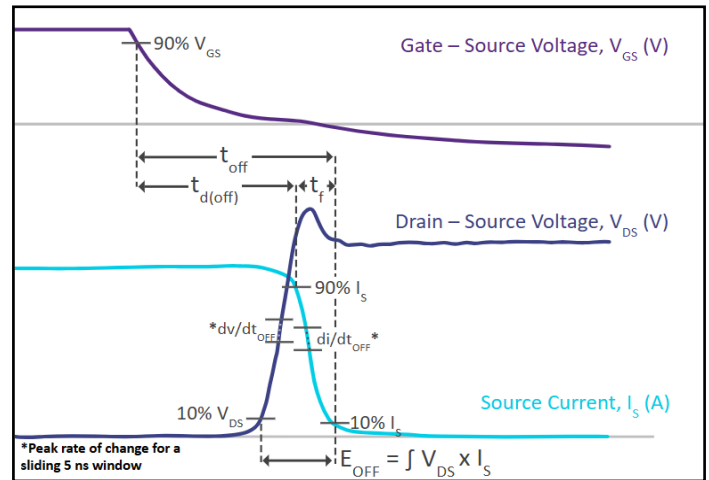

Figure 28. Turn Off Switching Time Definition

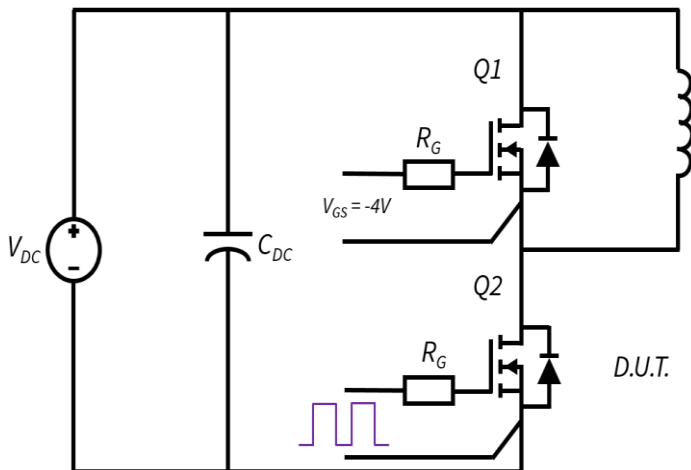

Figure 29. Clamped Inductive MOSFET Switching Waveform Test Circuit

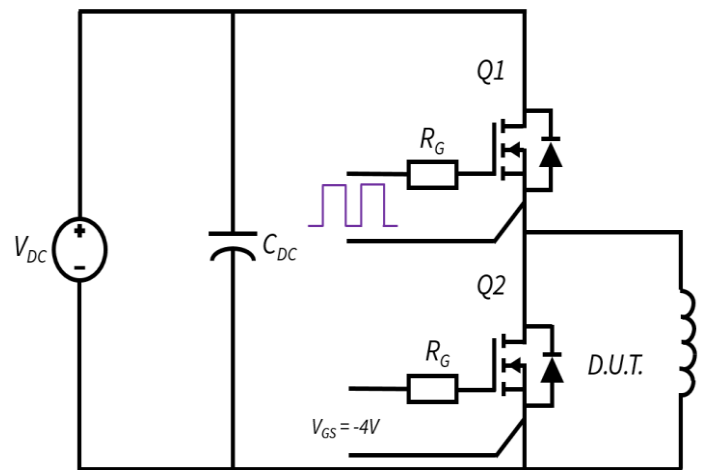
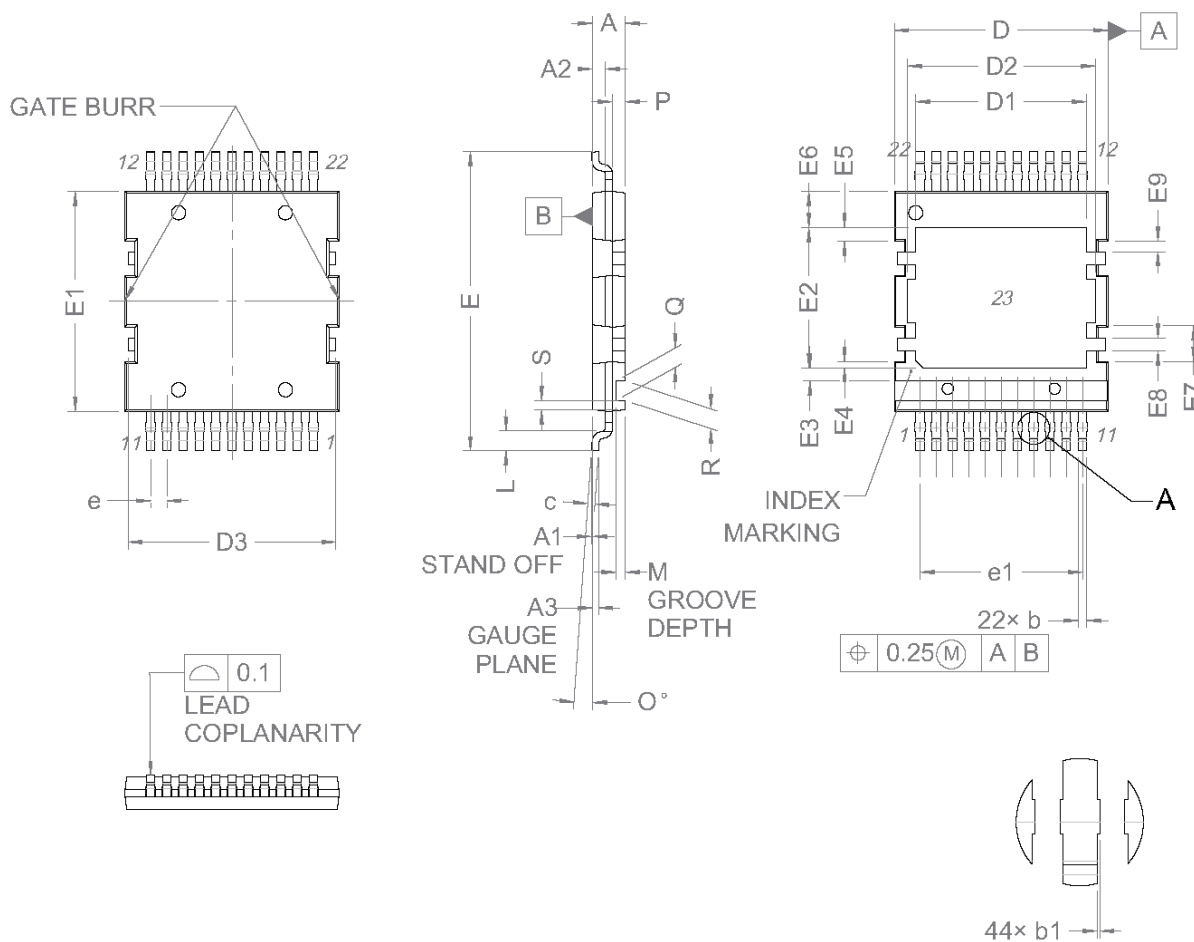

Figure 30. Clamped Inductive Body Diode Switching Waveform Test Circuit

## Package Dimensions



**DETAIL A**  
SCALE 8 : 1

SYMBOL	MIN	MAX	SYMBOL	MIN	MAX	PIN	DESCRIPTION
A	2.2	2.35	E6	2.53		1	GATE
A1	0	0.15	E7	2.4		2	KELVIN
A2	0.9		E8	0.9		3-11	SOURCE
A3	0.5		E9	0.75		12-23	DRAIN
b	0.5	0.7	e	1.14			
b1	-	0.15	e1	11.4			
c	0.46	0.58	L	1.3			
D	14.9	15.1	M	0.6			
D1	12		N	22			
D2	13.2		O	0°	8°		
D3	14.5	14.7	P	0.9			
E	20.81	21.11	P1	0.7	0.9		
E1	15.3	15.5	P2	0.9	1.1		
E2	9.83		Q	1.6			
E3	0.625		R	1.7			
E4	0.45		S	0.631			
E5	0.95						

**NOTE:**

1. ALL METAL SURFACES ARE TIN PLATED (MATTE), EXCEPT AREA OF CUT
2. ALL DIMENSIONS ARE LISTED IN MILLIMETERS. ANGLES IN DEGREES
3. DIMENSIONING & TOLERANCING CONFORM TO ASME Y14.5M-1994.
4. DIMENSIONS DO NOT INCLUDE MOLD FLASH (0.15mm MAX PER SIDE) OR GATE BURR (0.3mm MAX)
5. THE LEAD SIDE IS COMPREHENSIVE OF THE THICKNESS OF THE LEAD FINISH MATERIAL

### Recommended Solder Pad Layout

All dimensions in mm

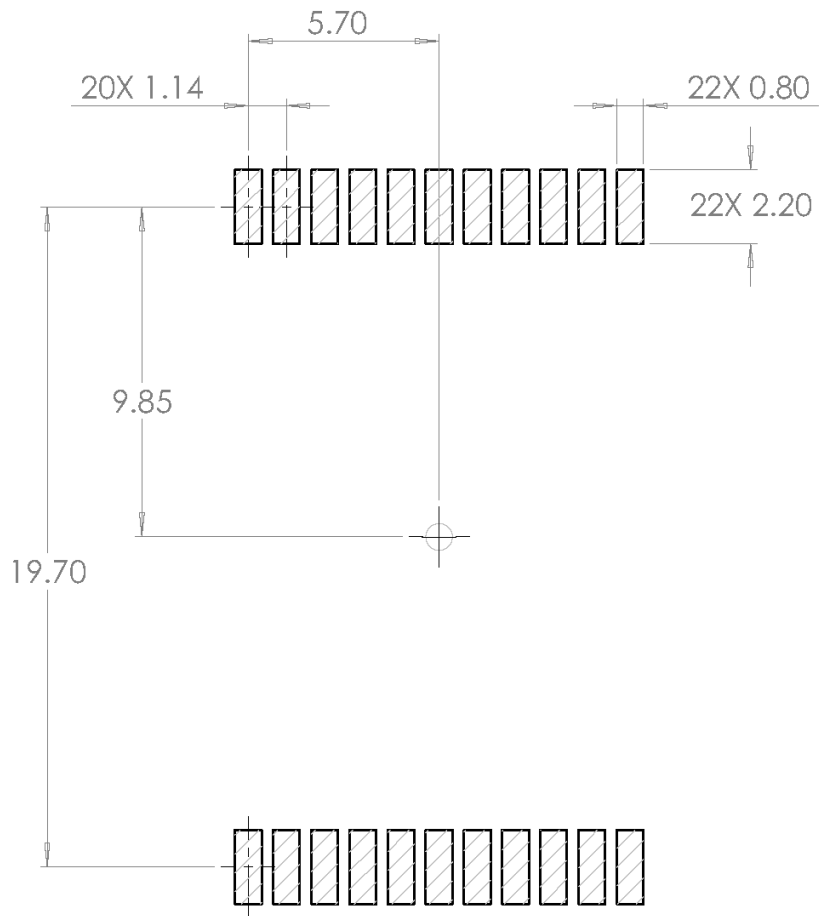



## Revision History

Documents Version	Date of Change	Description of Changes
1	6/10/2026	Initial Release

## Appendix

Appendix Number	Description
A1	<p>The following are recommendations for turning off the MOSFET with 0 V:</p> <ul style="list-style-type: none"><li>• Measure the <math>V_{GS}</math> spike accurately using high-CMRR probes and low common mode noise measurements.</li><li>• For the safe operation of the device, the voltage spike shall remain &lt; 5V for a time duration of &lt; 40 ns.</li></ul>



## Notes & Disclaimers

---

WOLFSPEED PROVIDES TECHNICAL AND RELIABILITY DATA, DESIGN RESOURCES, APPLICATION OR OTHER DESIGN ADVICE, WEB TOOLS, AND OTHER RESOURCES “AS IS” AND WITH ALL FAULTS, AND DISCLAIMS ALL WARRANTIES, EXPRESS AND IMPLIED, WITH RESPECT THERETO, INCLUDING WITHOUT LIMITATION ANY IMPLIED WARRANTIES OF MERCHANTABILITY, SUITABILITY, FITNESS FOR A PARTICULAR PURPOSE, OR NON-INFRINGEMENT OF THIRD-PARTY INTELLECTUAL PROPERTY RIGHTS.

This document and the information contained herein are subject to change without notice. Any such change shall be evidenced by the publication of an updated version of this document by Wolfspeed. No communication from any employee or agent of Wolfspeed or any third party shall effect an amendment or modification of this document. No responsibility is assumed by Wolfspeed for any infringement of patents or other rights of third parties which may result from use of the information contained herein. No license is granted by implication or otherwise under any patent or patent rights of Wolfspeed.

The information contained in this document (excluding examples, as well as figures or values that are labeled as “typical”) constitutes Wolfspeed’s sole published specifications for the subject product. “Typical” parameters are the average values expected by Wolfspeed in large quantities and are provided for informational purposes only. Any examples provided herein have not been produced under conditions intended to replicate any specific end use. Product performance can and does vary due to a number of factors.

This product has not been designed or tested for use in, and is not intended for use in, any application in which failure of the product would reasonably be expected to cause death, personal injury, or property damage. For purposes of (but without limiting) the foregoing, this product is not designed, intended, or authorized for use as a critical component in equipment implanted into the human body, life-support machines, cardiac defibrillators, and similar emergency medical equipment; air traffic control systems; or equipment used in the planning, construction, maintenance, or operation of nuclear facilities. Notwithstanding any application-specific information, guidance, assistance, or support that Wolfspeed may provide, the buyer of this product is solely responsible for determining the suitability of this product for the buyer’s purposes, including without limitation (1) selecting the appropriate Wolfspeed products for the buyer’s application, (2) designing, validating, and testing the buyer’s application, and (3) ensuring the buyer’s application meets applicable standards and any other legal, regulatory, and safety-related requirements.

### **RoHS Compliance**

The levels of RoHS restricted materials in this product are below the maximum concentration values (also referred to as the threshold limits) permitted for such substances, or are used in an exempted application, in accordance with EU Directive 2011/65/EC (RoHS2), as implemented January 2, 2013. RoHS Declarations for this product can be obtained from your Wolfspeed representative or from the Product Documentation sections of [www.wolfspeed.com](http://www.wolfspeed.com).

### **REACH Compliance**

REACH substances of high concern (SVHCs) information is available for this product. Since the European Chemical Agency (ECHA) has published notice of their intent to frequently revise the SVHC listing for the foreseeable future, please contact your Wolfspeed representative to ensure you get the most up-to-date REACH SVHC Declaration. REACH banned substance information (REACH Article 67) is also available upon request.

### **Contact info:**

4600 Silicon Drive  
Durham, NC 27703 USA  
Tel: +1.919.313.5300  
[www.wolfspeed.com/power](http://www.wolfspeed.com/power)