

CBB014A12FM4, CBB014A12FM4T

1200 V, 14 mΩ, Silicon Carbide, Full-Bridge Module

V_{DS}	1200 V
$R_{DS(on)}$	14 mΩ

Technical Features

- Fully SiC MOSFET-based for Ultra-Low Loss
- High-Ampacity Press-fit Pins (50 A per pin)
- High Thermal Performance Aluminum Nitride Substrate
- Comparative Tracking Index (CTI) > 600 for Material Group I
- Optional Pre-Applied Thermal Interface Material
- UL 1557 Certified

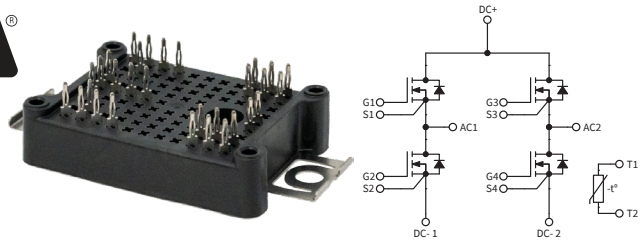

Typical Applications

- DC Fast Chargers
- Energy Storage Systems
- High-Efficiency Converters / Inverters
- Renewable Energy
- Smart-Grid / Grid-Tied Distributed Generation

System Benefits

- Enables Compact, Lightweight Systems
- Increased System Efficiency due to Low Switching & Conduction Losses of SiC
- Reduced Thermal Requirements and System Cost

Maximum Parameters (Verified by Design)

Parameter	Symbol	Min.	Typ.	Max.	Unit	Conditions	Note
Drain-Source Voltage	V_{DS}			1200	V		
Gate-Source Voltage, Maximum Value	$V_{GS(max)}$	-10		+23		Transient	Note 1
Gate-Source Voltage, Recommended	$V_{GS(op)}$		-4/+15..18			Static	Fig. 33
DC Continuous Drain Current	I_D		81		A	$V_{GS} = 15\text{ V}, T_{HS} = 75\text{ }^\circ\text{C}, T_{VJ} \leq 150\text{ }^\circ\text{C}$	Notes 2, 3, 4 Fig. 20
			87			$V_{GS} = 15\text{ V}, T_{HS} = 75\text{ }^\circ\text{C}, T_{VJ} \leq 175\text{ }^\circ\text{C}$	
DC Source-Drain Current (Body Diode)	$I_{SD(BD)}$		43			$V_{GS} = -4\text{ V}, T_{HS} = 75\text{ }^\circ\text{C}, T_{VJ} \leq 175\text{ }^\circ\text{C}$	
Pulsed Drain-Source Current	I_{DM}		348			t_{Pmax} limited by T_{VJmax} $V_{GS} = 15\text{ V}, T_{HS} = 25\text{ }^\circ\text{C}$	
Power Dissipation	P_D		200		W	$T_{HS} = 75\text{ }^\circ\text{C}, T_{VJ} \leq 175\text{ }^\circ\text{C}$	Note 4 Fig. 20
Virtual Junction Temperature	$T_{VJ(op)}$	-40		150	°C	Operation	
		-40		175		Intermittent with Reduced Life	

Note (1): Recommended turn-on gate voltage is 15 V with $\pm 5\%$ regulation tolerance

Note (2): Typical current limit calculated by $I_{D(max)} = \sqrt{(P_D/R_{DS(typ)}(T_{VJ(max)}))}$

Note (3): Verified by design

Note (4): $P_D = (T_{VJ} - T_{HS})/R_{TH(JHS,typ)}$



MOSFET Characteristics (Per Position) ($T_{VJ} = 25\text{ }^{\circ}\text{C}$ Unless Otherwise Specified)

Parameter	Symbol	Min.	Typ.	Max.	Unit	Conditions	Note
Drain-Source Breakdown Voltage	$V_{(BR)DSS}$	1200				$V_{GS} = 0\text{ V}, T_{VJ} = -40\text{ }^{\circ}\text{C}$	
Gate Threshold Voltage	$V_{GS(th)}$	1.8	2.7	4.0	V	$V_{DS} = V_{GS}, I_D = 21\text{ mA}$	
			2.2			$V_{DS} = V_{GS}, I_D = 21\text{ mA}, T_{VJ} = 175\text{ }^{\circ}\text{C}$	
Zero Gate Voltage Drain Current	I_{DSS}		1	100	μA	$V_{GS} = 0\text{ V}, V_{DS} = 1200\text{ V}$	
Gate-Source Leakage Current	I_{GSS}		10	400	nA	$V_{GS} = 15\text{ V}, V_{DS} = 0\text{ V}$	
Drain-Source On-State Resistance (Devices Only)	$R_{DS(on)}$		14	18	m Ω	$V_{GS} = 15\text{ V}, I_D = 75\text{ A}$	Fig. 2 Fig. 3
			23			$V_{GS} = 15\text{ V}, I_D = 75\text{ A}, T_{VJ} = 150\text{ }^{\circ}\text{C}$	
			26			$V_{GS} = 15\text{ V}, I_D = 75\text{ A}, T_{VJ} = 175\text{ }^{\circ}\text{C}$	
			12			$V_{GS} = 18\text{ V}, I_D = 75\text{ A}$	
			21			$V_{GS} = 18\text{ V}, I_D = 75\text{ A}, T_{VJ} = 150\text{ }^{\circ}\text{C}$	
			24			$V_{GS} = 18\text{ V}, I_D = 75\text{ A}, T_{VJ} = 175\text{ }^{\circ}\text{C}$	
Transconductance	g_{fs}		76		S	$V_{DS} = 20\text{ V}, I_{DS} = 75\text{ A}$	Fig. 4
			68			$V_{DS} = 20\text{ V}, I_{DS} = 75\text{ A}, T_{VJ} = 175\text{ }^{\circ}\text{C}$	
Turn-On Switching Energy, $T_{VJ} = 25\text{ }^{\circ}\text{C}$ $T_{VJ} = 125\text{ }^{\circ}\text{C}$ $T_{VJ} = 175\text{ }^{\circ}\text{C}$	E_{ON}		1.3 1.4 1.6		mJ	$V_{DS} = 600\text{ V},$ $I_D = 75\text{ A},$ $V_{GS} = -4\text{ V}/15\text{ V},$ $R_{G(OFF)} = 0.0\text{ }\Omega,$ $R_{G(ON)} = 0.0\text{ }\Omega,$ $L_{\sigma} = 14.0\text{ nH}$	Fig. 11 Fig. 13
Turn-Off Switching Energy, $T_{VJ} = 25\text{ }^{\circ}\text{C}$ $T_{VJ} = 125\text{ }^{\circ}\text{C}$ $T_{VJ} = 175\text{ }^{\circ}\text{C}$	E_{OFF}		0.50 0.56 0.59				
Internal Gate Resistance	$R_{G(int)}$		6.5		Ω	$f = 100\text{ kHz}$	
Input Capacitance	C_{iss}		7.02		nF	$V_{GS} = 0\text{ V}, V_{DS} = 1000\text{ V},$ $V_{AC} = 25\text{ mV}, f = 100\text{ kHz}$	Fig. 9
Output Capacitance	C_{oss}		0.20				
Reverse Transfer Capacitance	C_{rss}		17		pF		
Gate to Source Charge	Q_{GS}		67		nC	$V_{DS} = 800\text{ V}, V_{GS} = -4\text{ V}/15\text{ V}$ $I_D = 75\text{ A}$ Per IEC60747-8-4 pg 21	
Gate to Drain Charge	Q_{GD}		78				
Total Gate Charge	Q_G		261				
FET Thermal Resistance, Junction to Heatsink	$R_{th\text{ JHS}}$		0.504		$^{\circ}\text{C}/\text{W}$	With Pre-Applied TIM	Fig. 17



Diode Characteristics (Per Position) ($T_{VJ} = 25\text{ }^{\circ}\text{C}$ Unless Otherwise Specified)

Parameter	Symbol	Min.	Typ.	Max.	Unit	Conditions	Note
Body Diode Forward Voltage	V_{SD}		5.9		V	$V_{GS} = -4\text{ V}, I_{SD} = 75\text{ A}$	Fig. 7
			5.4			$V_{GS} = -4\text{ V}, I_{SD} = 75\text{ A}, T_{VJ} = 175\text{ }^{\circ}\text{C}$	
Reverse Recovery Time	t_{RR}		19.9		ns	$V_{GS} = -4\text{ V}, I_{SD} = 75\text{ A}, V_R = 600\text{ V}$ $di/dt = 9.0\text{ A/ns}, T_{VJ} = 175\text{ }^{\circ}\text{C}$	Fig. 32
Reverse Recovery Charge	Q_{RR}		1.0		μC		
Peak Reverse Recovery Current	I_{RRM}		85		A		
Reverse Recovery Energy $T_{VJ} = 25\text{ }^{\circ}\text{C}$ $T_{VJ} = 125\text{ }^{\circ}\text{C}$ $T_{VJ} = 175\text{ }^{\circ}\text{C}$	E_{RR}		0.19 0.22 0.26		mJ	$V_{DS} = 600\text{ V}, I_D = 75\text{ A},$ $V_{GS} = -4\text{ V}/15\text{ V}, R_{G(ON)} = 0.0\text{ }\Omega,$ $L_{\sigma} = 14.0\text{ nH}$	Fig. 14

Module Physical Characteristics

Parameter	Symbol	Min.	Typ.	Max.	Unit	Conditions
Package Resistance, M1 and M3 (High-Side)	R_{pkg1}		1.35		m Ω	$T_C = 125\text{ }^{\circ}\text{C}$, Note 5
Package Resistance, M2 and M4 (Low-Side)	R_{pkg2}		1.10			
Stray Inductance	L_{Stray}		11.0		nH	Between DC+ and DC-, $f = 10\text{ MHz}$
Case Temperature	T_C	-40		125	$^{\circ}\text{C}$	
Weight	W		21		g	
Mounting Torque	M_S		2.0	2.3	N-m	M4 bolts
Case Isolation Voltage	V_{isol}	3			kV	AC, 50 Hz, 1 min
Comparative Tracking Index	CTI	600				
Clearance Distance			4.2		mm	Terminal to Terminal
			13.5			Terminal to Heatsink
Creepage Distance			4.2			Terminal to Terminal
			13.5			Terminal to Heatsink

Note (5): Total Effective Resistance (Per Switch Position) = MOSFET $R_{DS(on)}$ + Switch Position Package Resistance

Temperature Sensor (NTC) Characteristics

Parameter	Symbol	Min.	Typ.	Max.	Unit	Test Conditions
Rated Resistance	R_{NTC}		5.0		k Ω	$T_{NTC} = 25\text{ }^{\circ}\text{C}$
Resistance Tolerance at 25 $^{\circ}\text{C}$	$\Delta R/R$	-5		5	%	
Beta Value ($T_2 = 50\text{ }^{\circ}\text{C}$)	$\beta_{25/50}$		3380		K	
Beta Value ($T_2 = 80\text{ }^{\circ}\text{C}$)	$\beta_{25/80}$		3468		K	
Beta Value ($T_2 = 100\text{ }^{\circ}\text{C}$)	$\beta_{25/100}$		3523		K	
Power Dissipation	P_{Max}			10	mW	$T_{NTC} = 25\text{ }^{\circ}\text{C}$

Typical Performance

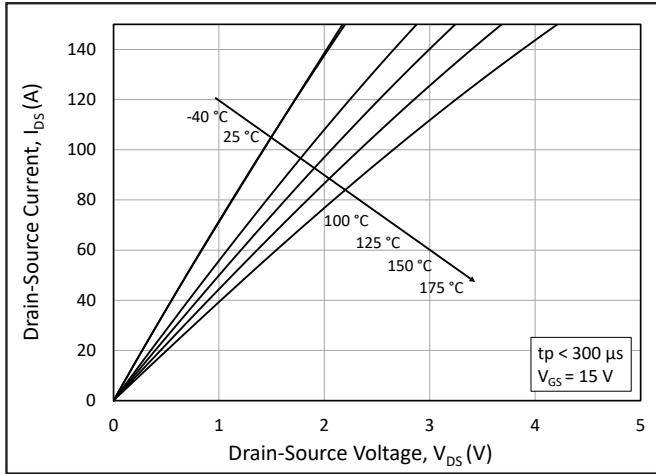

Figure 1. Output Characteristics for Various Junction Temperatures

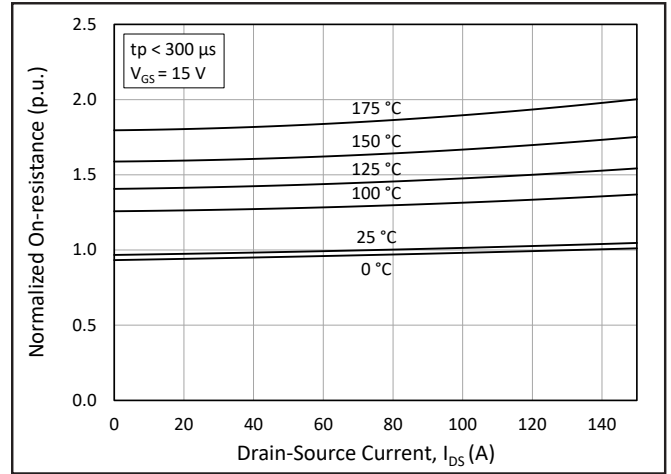

Figure 2. Normalized On-State Resistance vs. Drain Current for Various Junction Temperatures

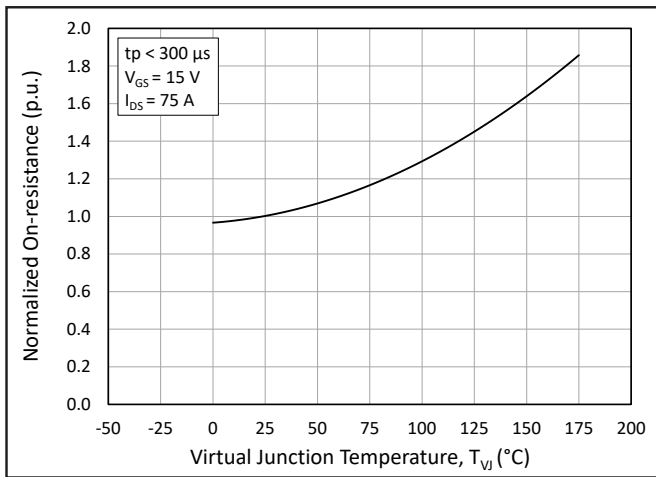

Figure 3. Normalized On-State Resistance vs. Junction Temperature

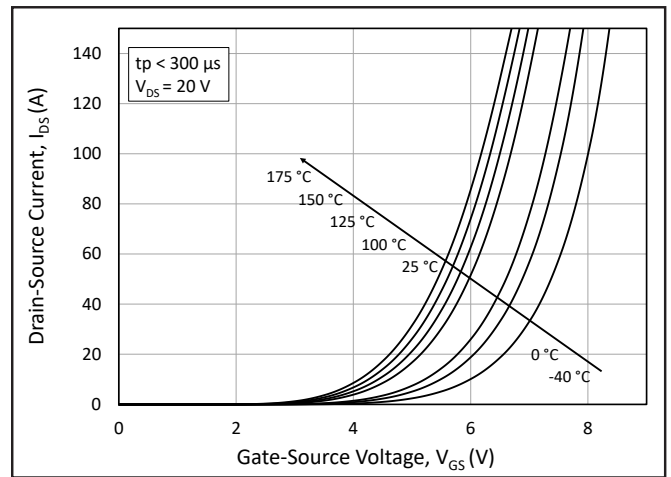

Figure 4. Transfer Characteristic for Various Junction Temperatures

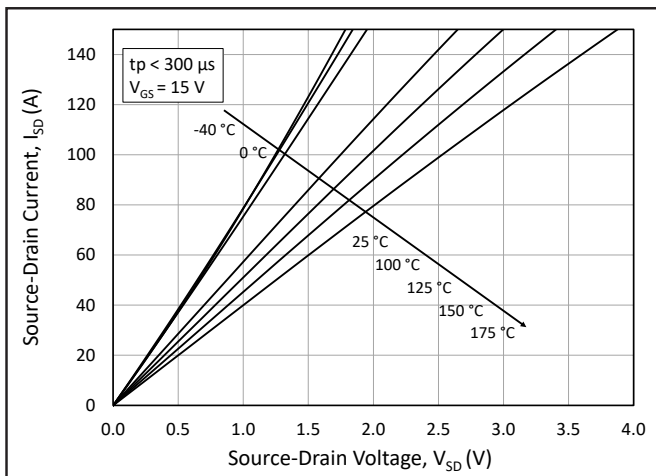

Figure 5. 3rd Quadrant Characteristic vs. Junction Temperatures at $V_{GS} = 15\text{ V}$

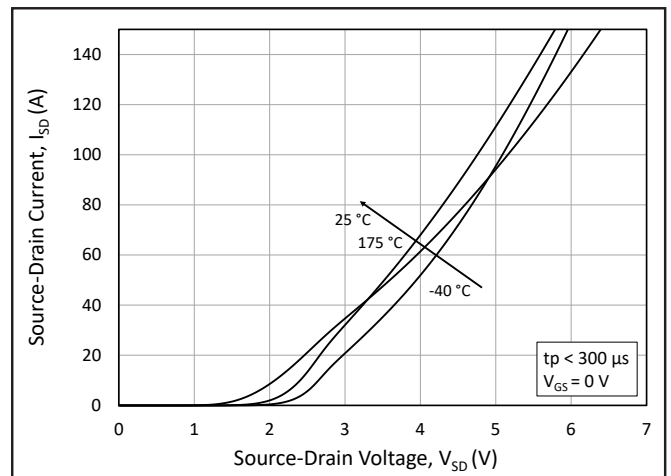

Figure 6. 3rd Quadrant Characteristic vs. Junction Temperatures at $V_{GS} = 0\text{ V}$ (Body Diode)



Typical Performance

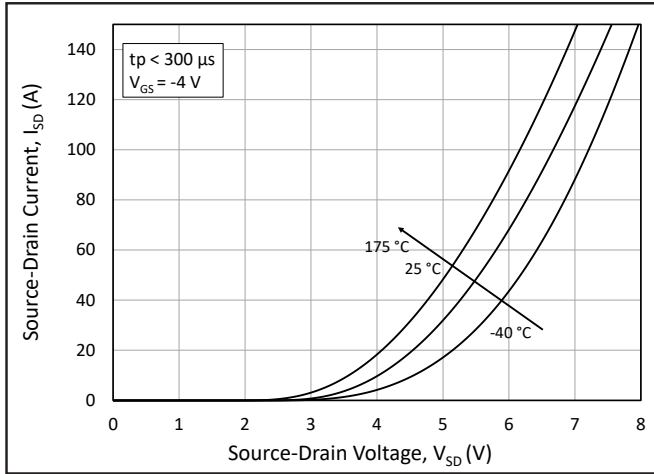

Figure 7. 3rd Quadrant Characteristic vs. Junction Temperatures at $V_{GS} = -4$ V (Body Diode)

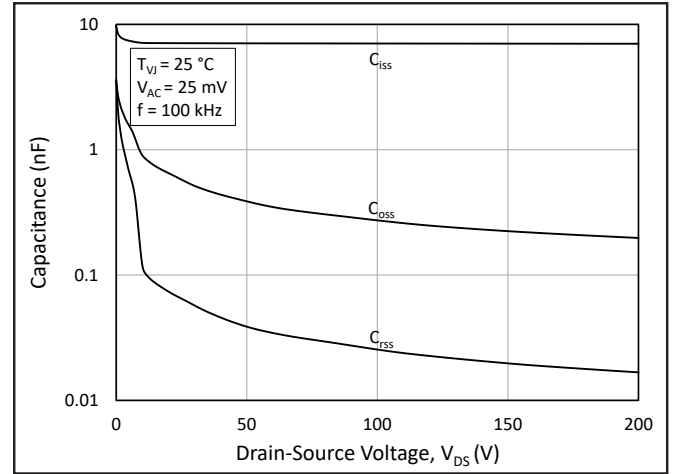

Figure 8. Typical Capacitances vs. Drain to Source Voltage (0 - 200 V)

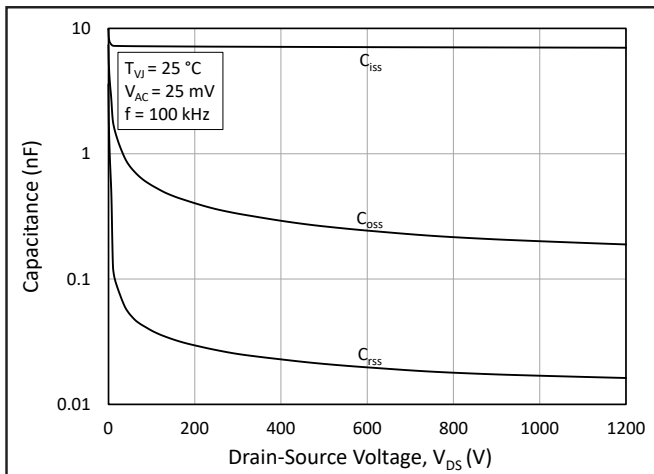

Figure 9. Typical Capacitances vs. Drain to Source Voltage (0 - 1200V)

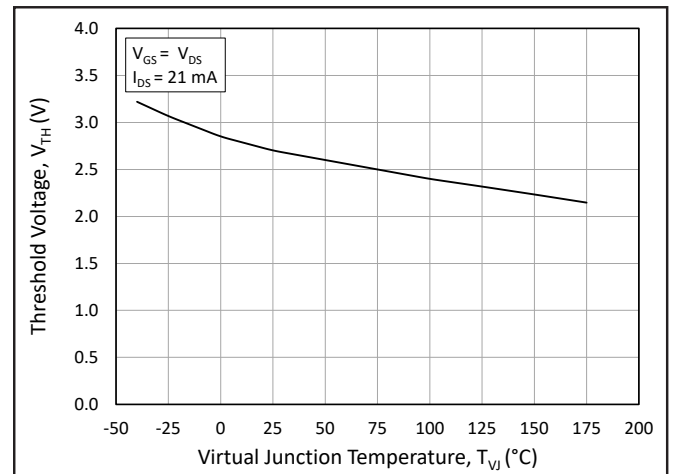

Figure 10. Threshold Voltage vs. Junction Temperature

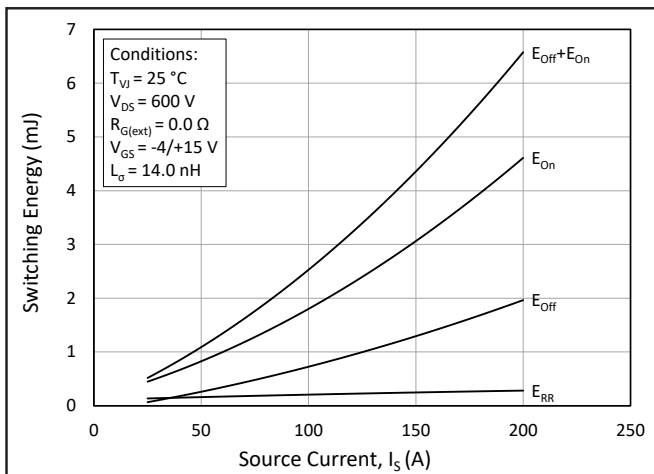

Figure 11. Switching Energy vs. Drain Current ($V_{DS} = 600$ V)

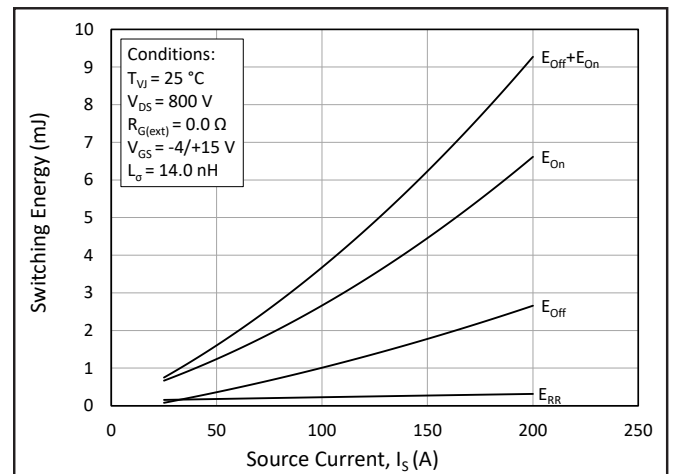

Figure 12. Switching Energy vs. Drain Current ($V_{DS} = 800$ V)



Typical Performance

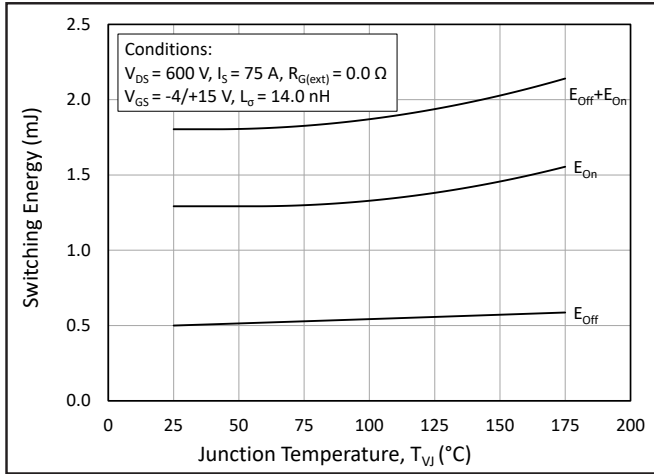

Figure 13. MOSFET Switching Energy vs. Junction Temperature

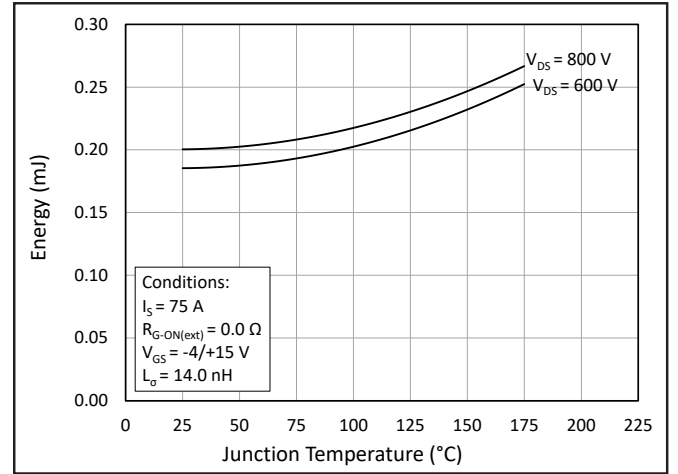

Figure 14. Reverse Recovery Energy vs. Junction Temperature

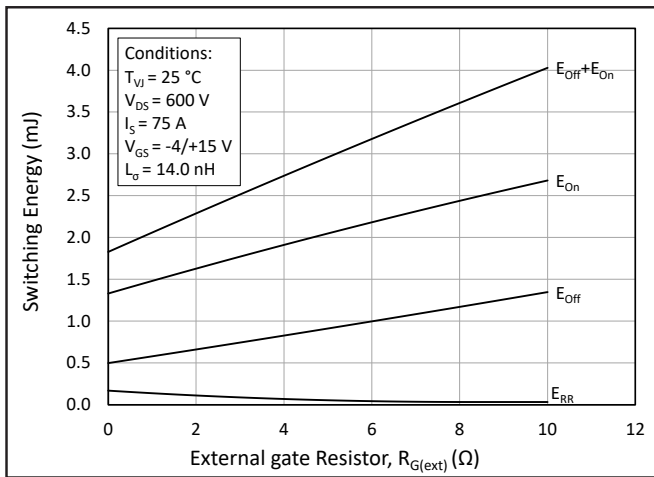

Figure 15. MOSFET Switching Energy vs. External Gate Resistance

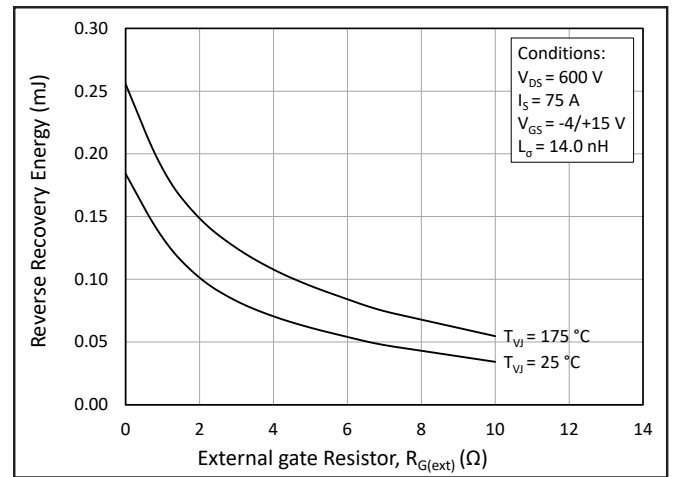

Figure 16. Reverse Recovery Energy vs. External Gate Resistance

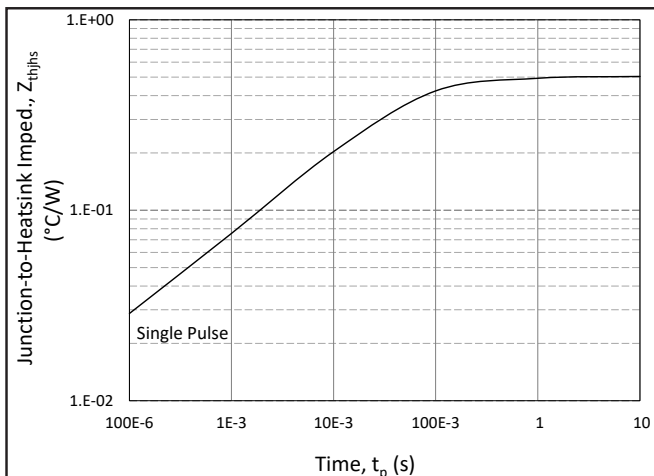

Figure 17. MOSFET Junction to Heatsink Transient Thermal Impedance, Z_{thHS} (°C/W)

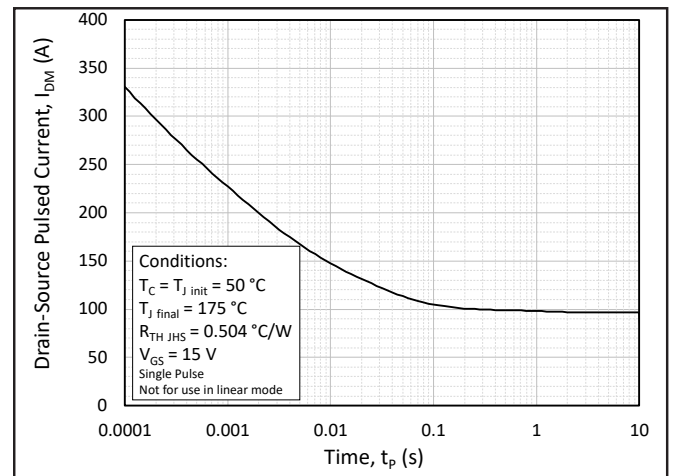

Figure 18. Pulsed Current SOA



Typical Performance

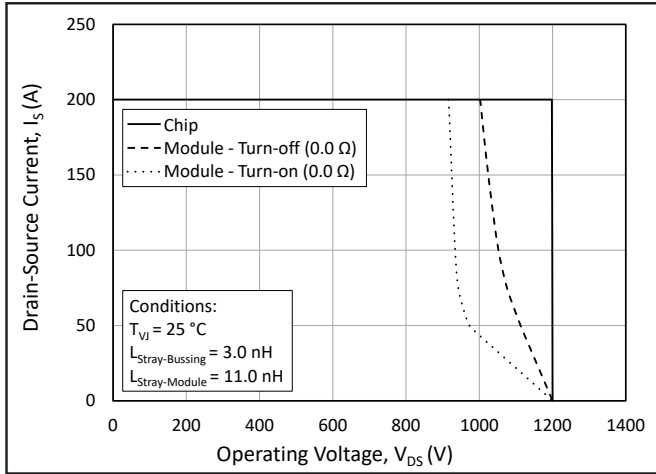

Figure 19. Switching Safe Operating Area

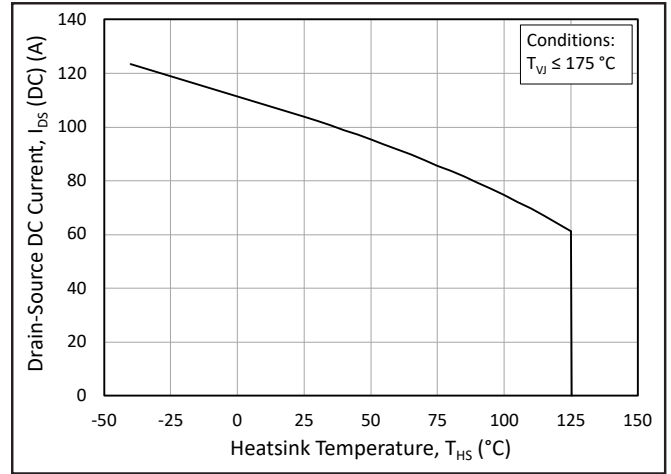

Figure 20. Continuous Drain Current Derating vs. Heatsink Temperature

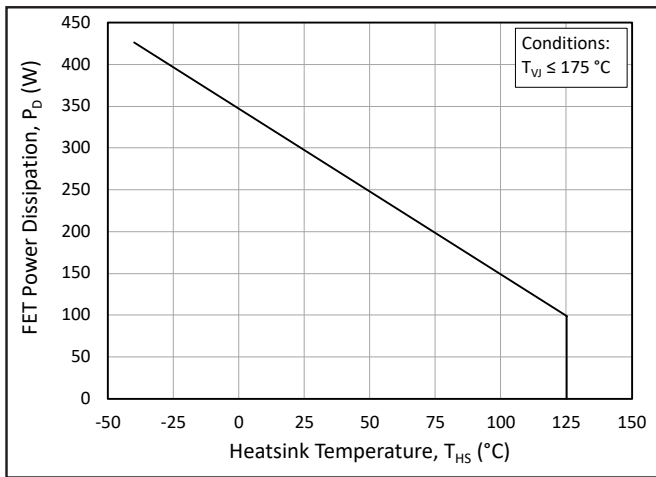

Figure 21. Maximum Power Dissipation Derating vs. Heatsink Temperature

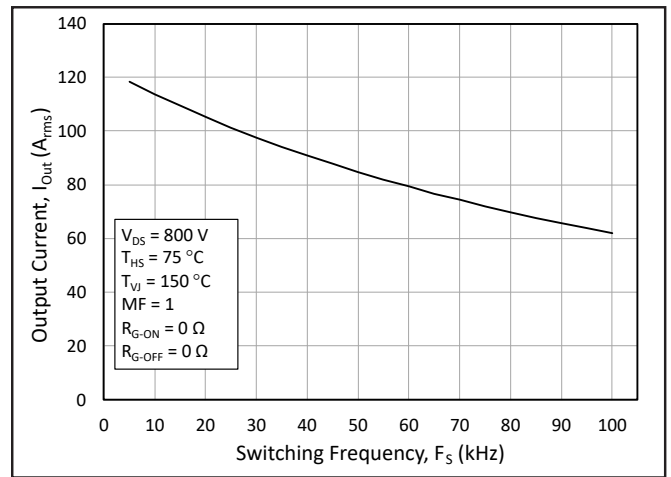

Figure 22. Typical Output Current Capability vs. Switching Frequency (Inverter Application)

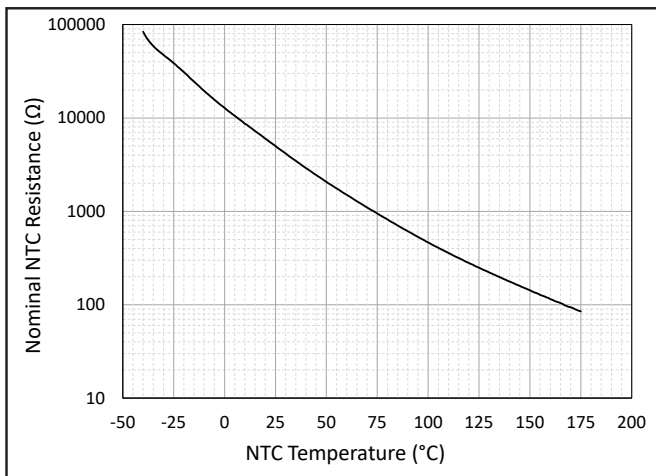

Figure 23. Typical NTC Resistance vs. Temperature



Timing Characteristics

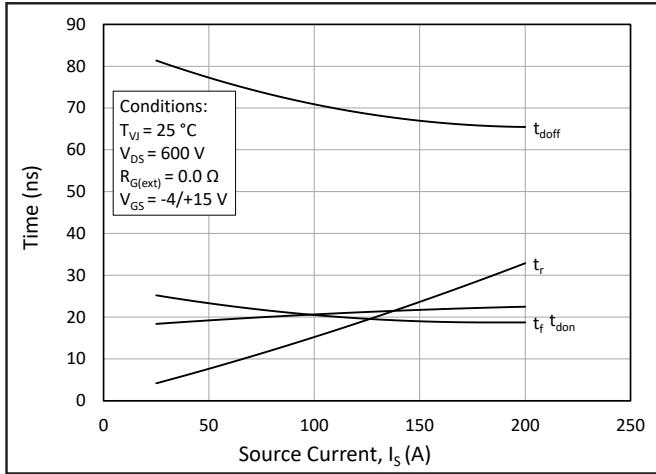

Figure 24. Timing vs. Source Current

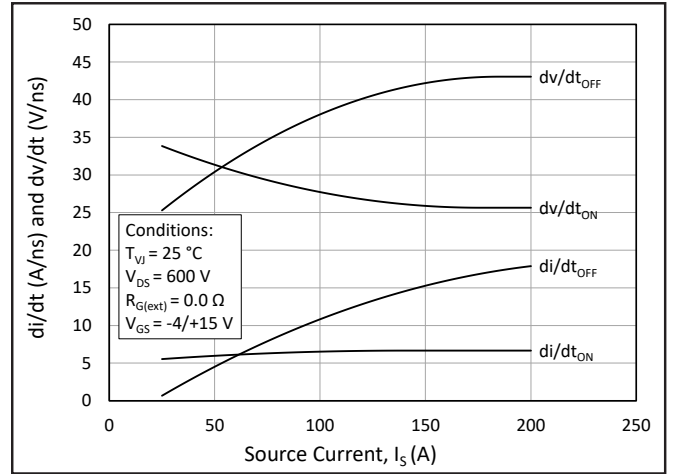

Figure 25. dv/dt and di/dt vs. Source Current

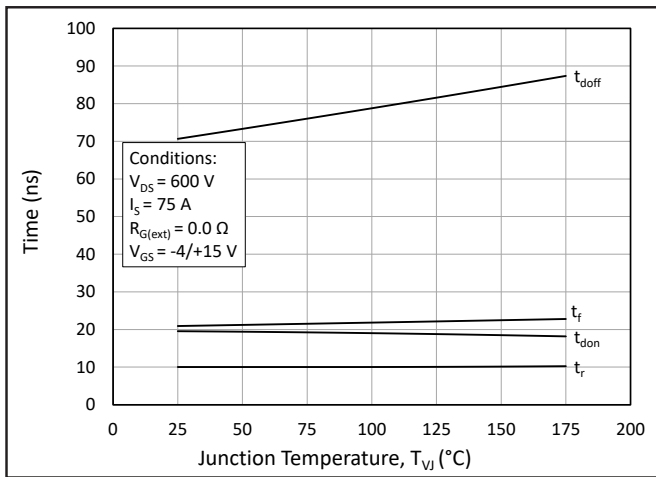

Figure 26. Timing vs. Junction Temperature

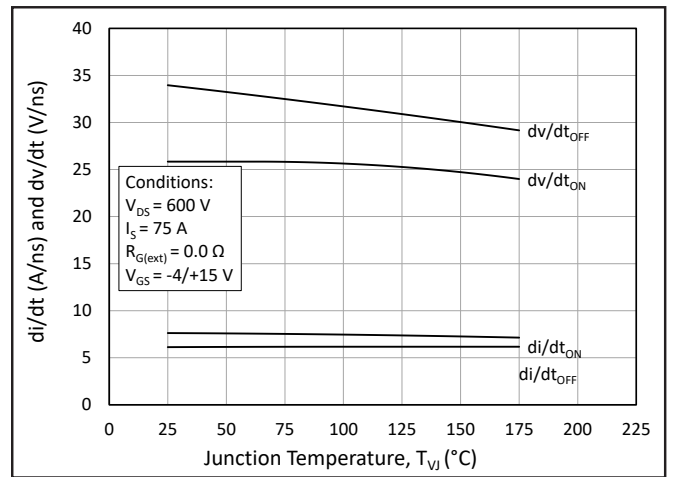

Figure 27. dv/dt and di/dt vs. Junction Temperature

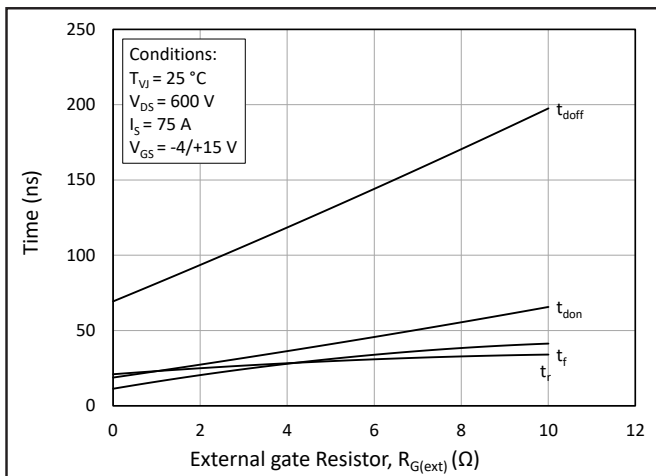

Figure 28. Timing vs. External Gate Resistance

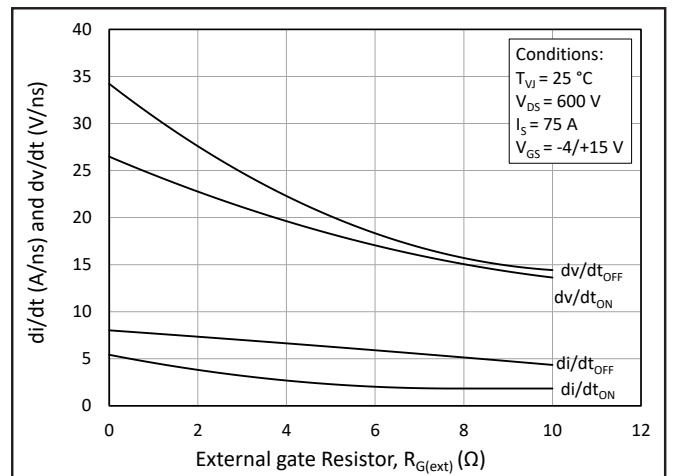

Figure 29. dv/dt and di/dt vs. External Gate Resistance

Definitions

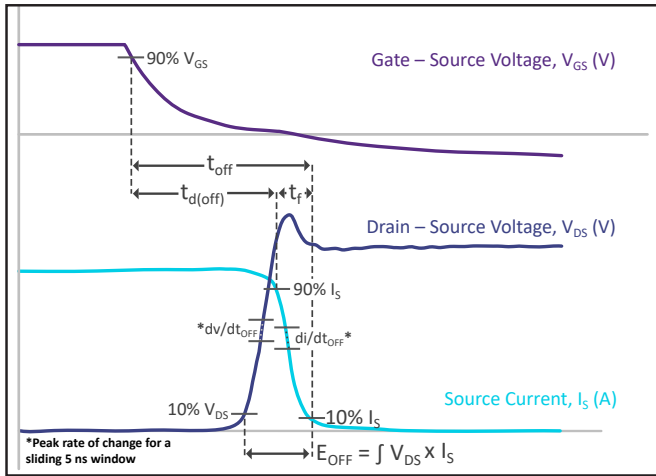

Figure 30. Turn-Off Transient Definitions

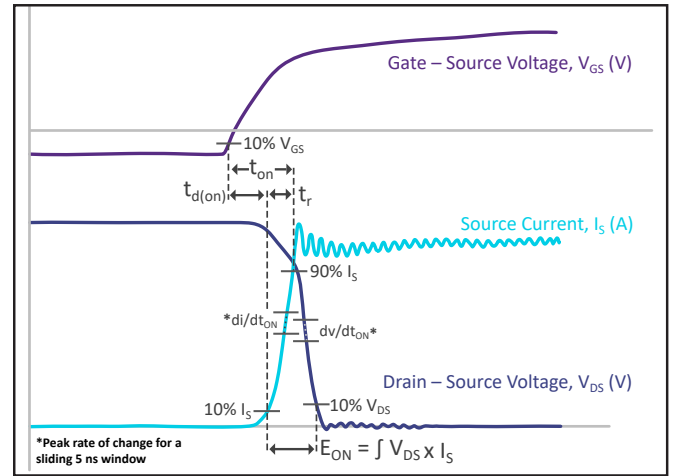

Figure 31. Turn-On Transient Definitions

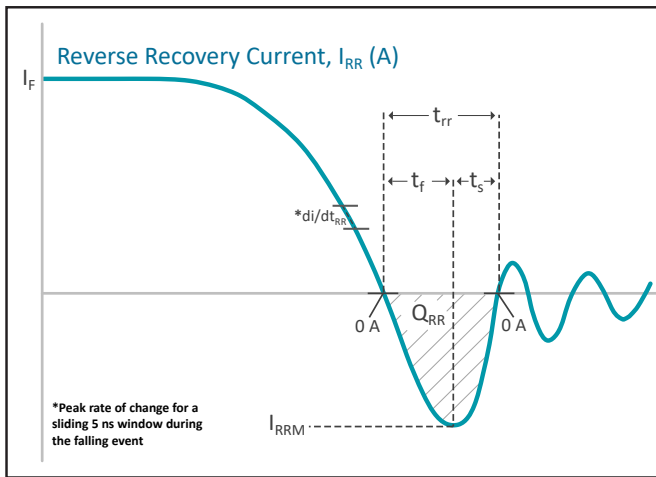

Figure 32. Reverse Recovery Definitions

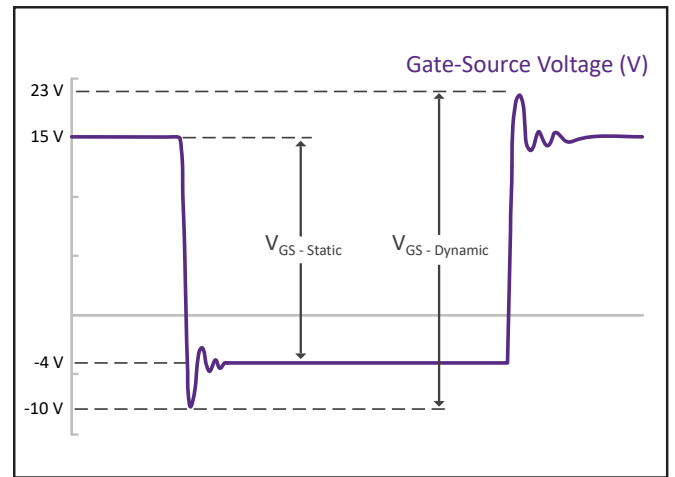
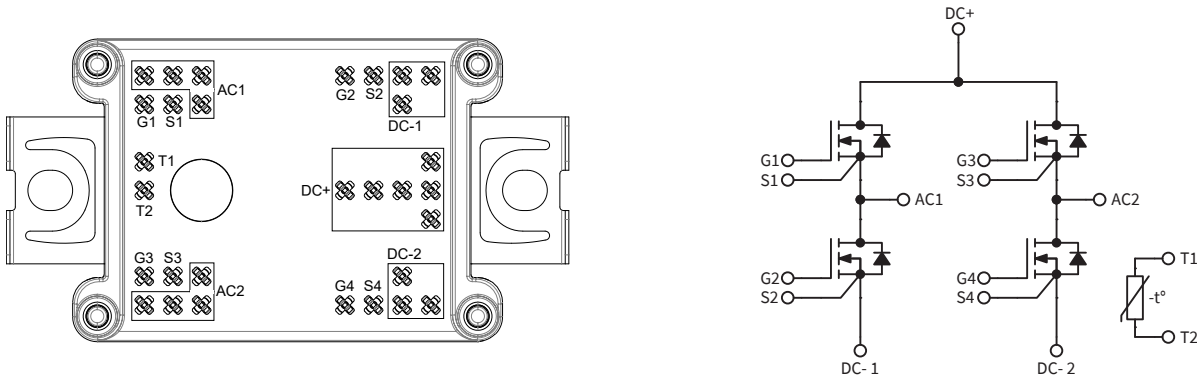

Figure 33. V_{GS} Transient Definitions

Note (6): A gate driver featuring the IXDD614SI gate driver IC was used to evaluate dynamic performance. The typical driver high-state output resistance of 0.4 ohms and low-state output resistance of 0.3 ohms are not included in the RG(ext) values on this datasheet.



Schematic and Pin Out



Package Dimensions (mm)

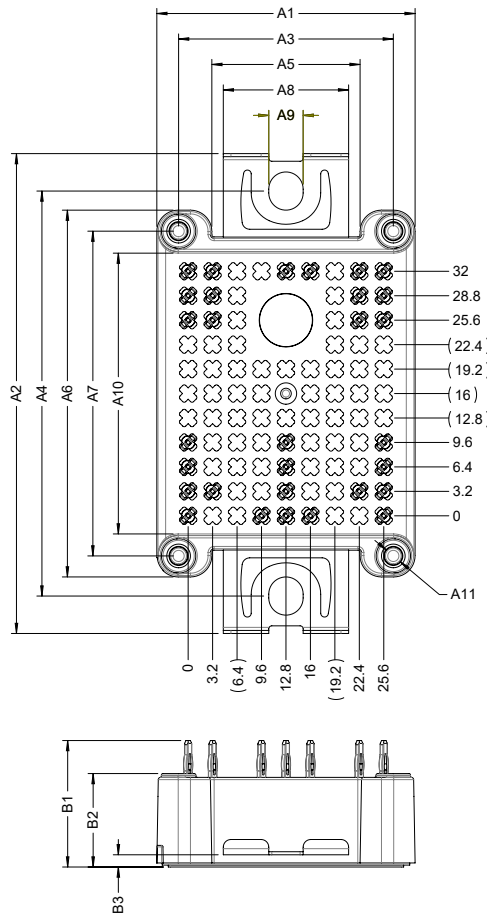

DIMENSION TABLE		
SYMBOL	DIMENSION	TOLERANCE
A1	33.8	±0.30
A2	62.8	±0.50
A3	28.1	±0.20
A4	53	±0.10
A5	19.4	±0.20
A6	48	±0.30
A7	42.5	±0.20
A8	16.4	±0.20
A9	4.5	^{+0.10} ₋₀
A10	36.7	±0.20
A11	∅2.3 ∇8.5	$\phi: \begin{matrix} +0 \\ -0.10 \end{matrix}$ $\nabla: \pm 0.30$
B1	16.4	±0.50
B2	12.25	±0.35
B3	1.6	±0.20
ALL PIN LOCATIONS		±0.40

Note (7): CBB014A12FM4 and CBB014A12FM4T has been certified by UL Solutions® as an “Electrically Isolated Semiconductor Devices – Component” in accordance with UL 1557. Only power modules that bear the UL marking shown should be considered as being covered under the UL Component Recognition Program.

Note (8): To improve product traceability, Wolfspeed products include Data Matrix Content barcodes in the form of ZZZZZZZZZZZZ-DDDDDD-XXXX-NNNNNNNNNN, where -Z, -D, -X/-N represent product number, date code, and module serial number, respectively. For instance, CCB021M12FM3T-IA2434-0018-0010468112 is a CCB021M12FM3T produced in 2024 week 34 with a unique serial number.



Product Ordering Code

Part Number	Description
CBB014A12FM4	Without Pre-Applied Phase Change Thermal Interface Material
CBB014A12FM4T	With Pre-Applied Phase Change Thermal Interface Material

Supporting Links & Tools

Evaluation Tools & Support

- [All LTSpice Models](#)
- [All PLECS Models](#)
- [SpeedFit® Design Simulator](#)
- [Technical Support Forum](#)

Dual-Channel Gate Driver Board

- [EVAL-ADUM4146WHB1Z: Analog Devices® Gate Driver Board](#)
- [UCC21710QDWEVM-054: Texas Instruments® Gate Driver Board](#)
- [Si823H-AxWA-KIT: Skyworks® Gate Driver Board](#)
- [ACPL-355JC: Broadcom® Gate Driver Board](#)
- [CGD1700HB2M-UNA: Wolfspeed Gate Driver Board](#)
- [CGD12HB00D: Differential Transceiver Daughter Board Companion Tool for Differential Gate Drivers](#)

Application Notes

- [PRD-02302: WolfPACK™ Mounting Instructions and PCB Requirements](#)
- [PRD-04814: Design Options for Wolfspeed® Silicon Carbide MOSFET Gate Bias Power Supplies](#)
- [PRD-06379: Environmental Considerations for Power Electronics Systems](#)
- [PRD-07845: Power Module Baseplate Capacitance and Electromagnetic Compatibility](#)
- [PRD-07933: Wolfspeed Power Module Thermal Interface Material Application User Guide](#)
- [PRD-07968: Wolfspeed WolfPACK™ Dynamic Performance](#)
- [PRD-08333: Wolfspeed Module CIL Evaluation Kits User Guide](#)
- [PRD-08376: Thermal Characterization Methods and Applications](#)
- [PRD-08710: Measuring Stray Inductance in Power Electronics Systems](#)
- [PRD-08911: Considerations for Current Balancing in Paralleled SiC Power Modules](#)
- [PRD-09035: Power Module RC Thermal Models User Guide](#)



Notes & Disclaimers

WOLFSPEED PROVIDES TECHNICAL AND RELIABILITY DATA, DESIGN RESOURCES, APPLICATION OR OTHER DESIGN ADVICE, WEB TOOLS, AND OTHER RESOURCES “AS IS” AND WITH ALL FAULTS, AND DISCLAIMS ALL WARRANTIES, EXPRESS AND IMPLIED, WITH RESPECT THERETO, INCLUDING WITHOUT LIMITATION ANY IMPLIED WARRANTIES OF MERCHANTABILITY, SUITABILITY, FITNESS FOR A PARTICULAR PURPOSE, OR NON-INFRINGEMENT OF THIRD-PARTY INTELLECTUAL PROPERTY RIGHTS.

This document and the information contained herein are subject to change without notice. Any such change shall be evidenced by the publication of an updated version of this document by Wolfspeed. No communication from any employee or agent of Wolfspeed or any third party shall effect an amendment or modification of this document. No responsibility is assumed by Wolfspeed for any infringement of patents or other rights of third parties which may result from use of the information contained herein. No license is granted by implication or otherwise under any patent or patent rights of Wolfspeed.

The information contained in this document (excluding examples, as well as figures or values that are labeled as “typical”) constitutes Wolfspeed’s sole published specifications for the subject product. “Typical” parameters are the average values expected by Wolfspeed in large quantities and are provided for informational purposes only. Any examples provided herein have not been produced under conditions intended to replicate any specific end use. Product performance can and does vary due to a number of factors.

This product has not been designed or tested for use in, and is not intended for use in, any application in which failure of the product would reasonably be expected to cause death, personal injury, or property damage. For purposes of (but without limiting) the foregoing, this product is not designed, intended, or authorized for use as a critical component in equipment implanted into the human body, life-support machines, cardiac defibrillators, and similar emergency medical equipment; air traffic control systems; or equipment used in the planning, construction, maintenance, or operation of nuclear facilities. Notwithstanding any application-specific information, guidance, assistance, or support that Wolfspeed may provide, the buyer of this product is solely responsible for determining the suitability of this product for the buyer’s purposes, including without limitation (1) selecting the appropriate Wolfspeed products for the buyer’s application, (2) designing, validating, and testing the buyer’s application, and (3) ensuring the buyer’s application meets applicable standards and any other legal, regulatory, and safety-related requirements.

RoHS Compliance

The levels of RoHS restricted materials in this product are below the maximum concentration values (also referred to as the threshold limits) permitted for such substances, or are used in an exempted application, in accordance with EU Directive 2011/65/EC (RoHS2), as implemented January 2, 2013. RoHS Declarations for this product can be obtained from your Wolfspeed representative or from the Product Documentation sections of www.wolfspeed.com.

REACH Compliance

REACH substances of high concern (SVHCs) information is available for this product. Since the European Chemical Agency (ECHA) has published notice of their intent to frequently revise the SVHC listing for the foreseeable future, please contact your Wolfspeed representative to ensure you get the most up-to-date REACH SVHC Declaration. REACH banned substance information (REACH Article 67) is also available upon request.

Contact info:

4600 Silicon Drive
Durham, NC 27703 USA
Tel: +1.919.313.5300
www.wolfspeed.com/power