

C4MS015075K1

Switching Optimized 750V 15mΩ Industrial Silicon Carbide Power MOSFET

Features

- Industry compatible drive voltage 15V...18V/-5V...0V
- Soft body diode with low Vds overshoot and ringing
- Low Rds(on) at high operating temperatures
- Improved device capacitance ratio (Ciss/Crss)
- High transient voltage robustness with improved lifetime
- Halogen free, RoHS compliant

Benefits

- Higher efficiency, lower switching losses and reduced EMI
- Faster switching operation enabling high power density
- Enables system level price performance optimization
- Reduction in system-level cooling requirements

Typical Applications

- Data Center Power Supplies
- EV Chargers
- Solar/ESS
- Motor Control
- Industrial Power Supplies
- High Voltage DC/DC Converters

Package

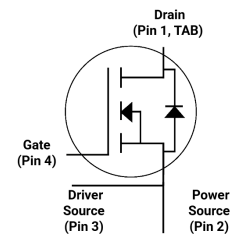

Orderable Part Number	Package Type	Marking
C4MS015075K1	TO-247-4 LP	C4MS015075K1

Key Parameters

Parameter	Symbol	Min.	Typ.	Max	Unit	Conditions	Note
Drain-Source Voltage	V_{DS}			750	V		
Maximum Gate-Source Voltage	$V_{GS(max)}$	-10		+23			Note 1
DC Continuous Drain Current	I_D		151		A	$V_{GS} = 18V, T_c = 25^\circ C, T_J \leq 175^\circ C$	Note 2
			109			$V_{GS} = 18V, T_c = 100^\circ C, T_J \leq 175^\circ C$	
Pulsed Drain Current	I_{DM}			319		t_{Pmax} limited by T_{Jmax} $V_{GS} = 18V, T_c = 25^\circ C$	
Power Dissipation	P_D		514		W	$T_c = 25^\circ C, T_J = 175^\circ C$	Note 3
Operating Junction and Storage Temperature	T_J, T_{stg}	-55		+175	°C		
Solder Temperature	T_L			260		According to JEDEC J-STD-020	

Note (1): When applying IPC-9592B or OCP M-CRPS derating standards, a maximum Gate-Source voltage (V_{GS}) of +25V is permissible.

Note (2): Current limit calculated by $I_{D(max)} = \sqrt{(P_D / R_{DS(typ)}) (T_{J(max)} - T_{D(max)})}$

Note (3): $P_D = (T_J - T_c) / R_{th(JC, typ)}$



Electrical Characteristics ($T_c = 25^\circ\text{C}$ unless otherwise specified)

Symbol	Parameter	Min.	Typ.	Max.	Unit	Test Conditions	Note
$V_{(BR)DSS}$	Drain-Source Breakdown Voltage	750			V	$V_{GS} = 0\text{ V}, I_D = 100\ \mu\text{A}$	
$V_{GS(th)}$	Gate Threshold Voltage	2.0	2.6	3.9	V	$V_{DS} = V_{GS}, I_D = 12.55\ \text{mA}$	Fig. 11
			2.0		V	$V_{DS} = V_{GS}, I_D = 12.55\ \text{mA}, T_J = 175^\circ\text{C}$	
I_{DSS}	Zero Gate Voltage Drain Current		1	50	μA	$V_{DS} = 750\ \text{V}, V_{GS} = 0\ \text{V}$	
I_{GSS}	Gate-Source Leakage Current		10	250	nA	$V_{GS} = 18\ \text{V}, V_{DS} = 0\ \text{V}$	
$V_{GS(op)}$	Recommended Turn on Gate-Source Voltage		15...18		V		Refer to PRD-09634
	Recommended Turn off Gate-Source Voltage		-5...0				
$R_{DS(on)}$	Drain-Source On-State Resistance		15	19.5	m Ω	$V_{GS} = 18\ \text{V}, I_D = 45.6\ \text{A}$	Fig. 4, 5, 6
			22.1			$V_{GS} = 18\ \text{V}, I_D = 45.6\ \text{A}, T_J = 175^\circ\text{C}$	
			18.3			$V_{GS} = 15\ \text{V}, I_D = 45.6\ \text{A}$	
g_{fs}	Transconductance		33		S	$V_{DS} = 20\ \text{V}, I_D = 45.6\ \text{A}$	Fig. 7
			34			$V_{DS} = 20\ \text{V}, I_D = 45.6\ \text{A}, T_J = 175^\circ\text{C}$	
$R_{DS(on)Tempco}$	On resistance temperature coefficient		1.47			$V_{GS} = 18\ \text{V}, I_D = 45.6\ \text{A}$	Note 4
C_{iss}	Input Capacitance		3702		pF	$V_{GS} = 0\ \text{V}, V_{DS} = 500\ \text{V}$ $f = 100\ \text{kHz}$ $V_{AC} = 25\ \text{mV}$	Fig. 17, 18
C_{oss}	Output Capacitance		222				
C_{rss}	Reverse Transfer Capacitance		8.6				
C_{iss}/C_{rss}	Capacitance Ratio		430				Note 5
E_{oss}	C_{oss} Stored Energy		35.7		μJ		Fig. 16
$C_{o(er)}$	Effective Output Capacitance (Energy Related)		280		pF	$V_{GS} = 0\ \text{V}, V_{DS} = 0...500\ \text{V}$	Note 6
$C_{o(tr)}$	Effective Output Capacitance (Time Related)		445				
E_{on}	Turn-On Switching Energy (Body Diode FWD) $T_J = 25^\circ\text{C}$ $T_J = 175^\circ\text{C}$		201		μJ	$V_{DS} = 500\ \text{V}, V_{GS} = -4\ \text{V}/18\ \text{V}$ $I_D = 45.6\ \text{A}, R_{G(ext)} = 2\ \Omega, L_\sigma = 25\ \text{nH}$	Fig. 25, 27, 29
			203				Fig. 25, 28, 29
E_{off}	Turn-Off Switching Energy (Body Diode FWD) $T_J = 25^\circ\text{C}$ $T_J = 175^\circ\text{C}$		70				Fig. 25, 28, 29
			71				
$t_{d(on)}$	Turn-On Delay Time		12.9		ns	$V_{DD} = 500\ \text{V}, V_{GS} = -4\ \text{V}/18\ \text{V}$ $I_D = 45.6\ \text{A}, R_{G(ext)} = 2\ \Omega, L_\sigma = 25\ \text{nH}$ Inductive load	Fig. 26, 27, 28, 29
t_r	Rise Time		5.2				
$t_{d(off)}$	Turn-Off Delay Time		40.2				
t_f	Fall Time		9.8				
$R_{G(int)}$	Internal Gate Resistance		2.2		Ω	$f = 1\ \text{MHz}$	
Q_{gs}	Gate to Source Charge		41		nC	$V_{DS} = 500\ \text{V}, V_{GS} = -4\ \text{V}/18\ \text{V}$ $I_D = 45.6\ \text{A}$ Per IEC60747-8-4	Fig. 12
Q_{gd}	Gate to Drain Charge		43				
Q_g	Total Gate Charge		147				

Note (4): $R_{DS(on)Tempco}$ refers to $R_{DS(on)}$ at 175°C / $R_{DS(on)}$ at 25°C , C4MS 750V product family value

Note (5): Capacitance ratio is a FOM for Partial turn-on immunity PRD-06933, C4MS 750V product family value

Note (6): $C_{o(er)}$ a lumped capacitance that gives the same stored energy as C_{oss} while V_{ds} is rising from 0 to 500 V

$C_{o(tr)}$ a lumped capacitance that gives the same charging time as C_{oss} while V_{ds} is rising from 0 to 500 V



Reverse Diode Characteristics ($T_c = 25^\circ\text{C}$ unless otherwise specified)

Symbol	Parameter	Typ.	Max.	Unit	Test Conditions	Note
V_{SD}	Diode Forward Voltage	5.1		V	$V_{GS} = -4\text{ V}, I_{SD} = 22.8\text{ A}$	Fig. 8, 9, 10
		4.5		V	$V_{GS} = -4\text{ V}, I_{SD} = 22.8\text{ A}, T_J = 175^\circ\text{C}$	
I_S	Continuous Diode Forward Current	80		A	$V_{GS} = -4\text{ V}$	
I_{SM}	Diode Pulse Current		319	A	$V_{GS} = -4\text{ V}$, pulse width t_p limited by T_{Jmax}	
t_{rr}	Reverse Recovery Time	10.6		ns	$V_{SD} = 500\text{ V}, V_{GS} = -4\text{ V}, T_J = 175^\circ\text{C}$ $I_S = 45.6\text{ A}, di_F/dt = 11.3\text{ A/ns}$	Fig. 30
Q_{rr}	Reverse Recovery Charge	467.5		nC		
I_{RRM}	Peak Reverse Recovery Current	75		A		
E_{RR}	Reverse recovery Energy $T_J = 25^\circ\text{C}$ $T_J = 175^\circ\text{C}$	160 170		μJ	$V_{DS} = 500\text{ V}, V_{GS} = -4\text{ V}/18\text{ V}$ $I_D = 45.6\text{ A}, R_{G(on)} = 2\ \Omega, L_\sigma = 25\text{ nH}$	

Thermal Characteristics

Symbol	Parameter	Typ.	Max.	Unit	Test Conditions	Note
$R_{\theta JC}$	Thermal Resistance from Junction to Case	0.29		$^\circ\text{C/W}$		



Typical Performance

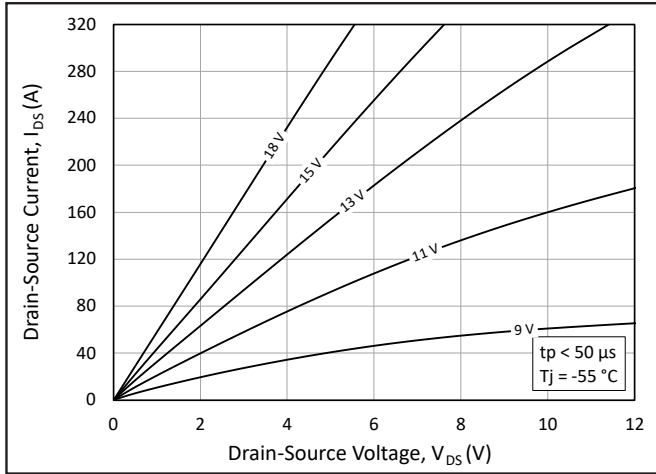

Figure 1. Output Characteristics $T_J = -55^\circ\text{C}$

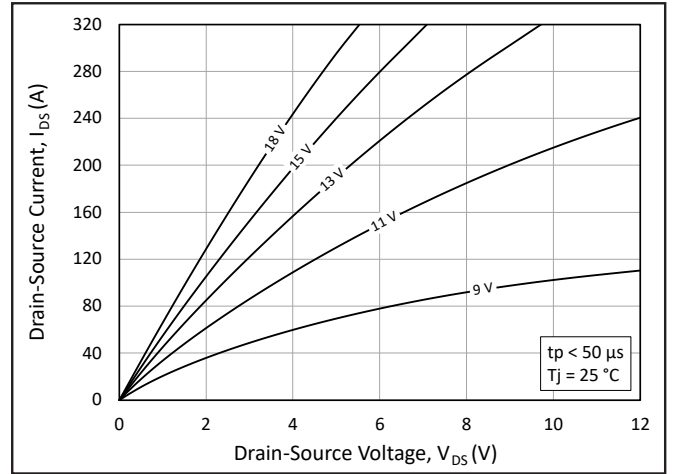

Figure 2. Output Characteristics $T_J = 25^\circ\text{C}$

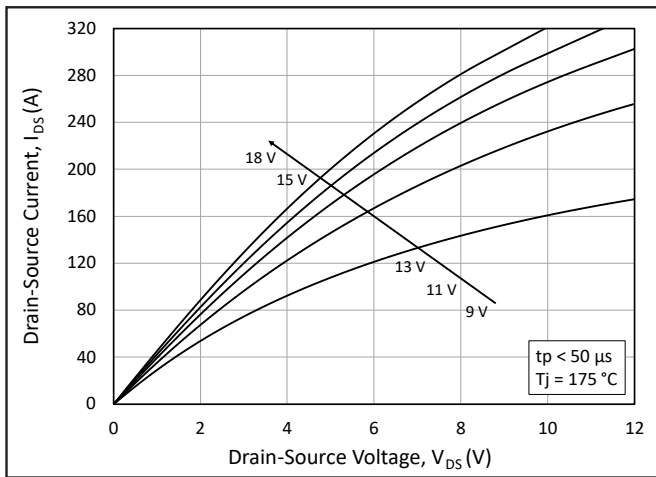

Figure 3. Output Characteristics $T_J = 175^\circ\text{C}$

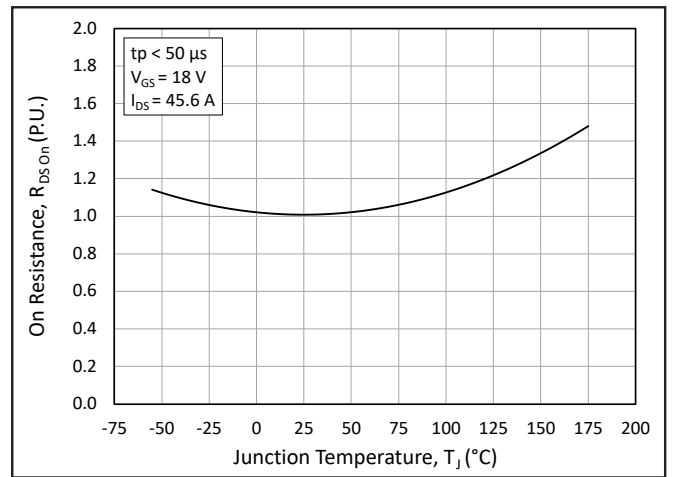

Figure 4. Normalized On-Resistance vs. Temperature

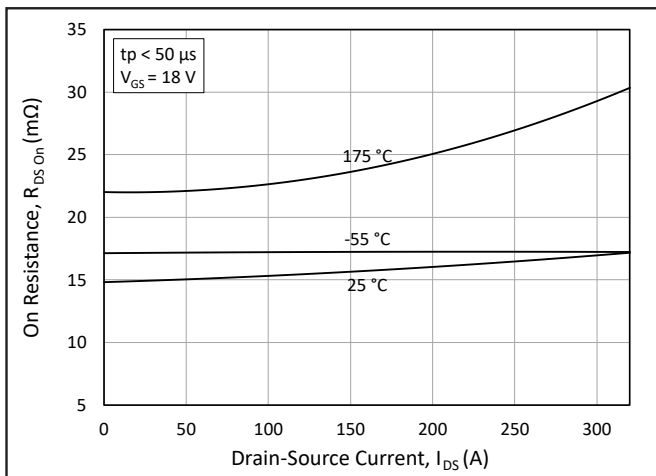

Figure 5. On-Resistance vs. Drain Current For Various Temperatures

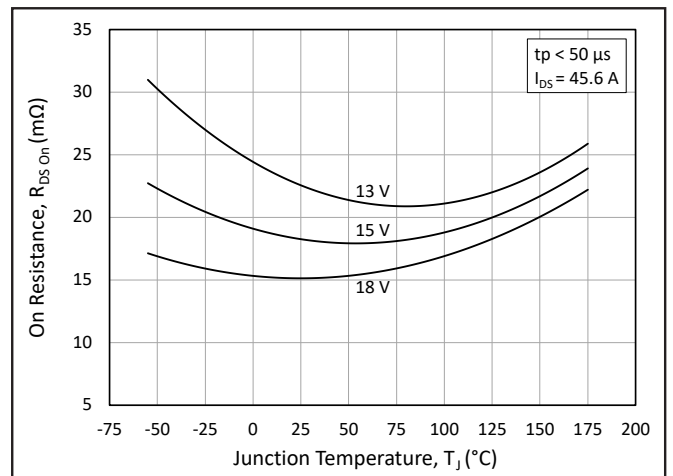

Figure 6. On-Resistance vs. Temperature For Various Gate Voltage



Typical Performance

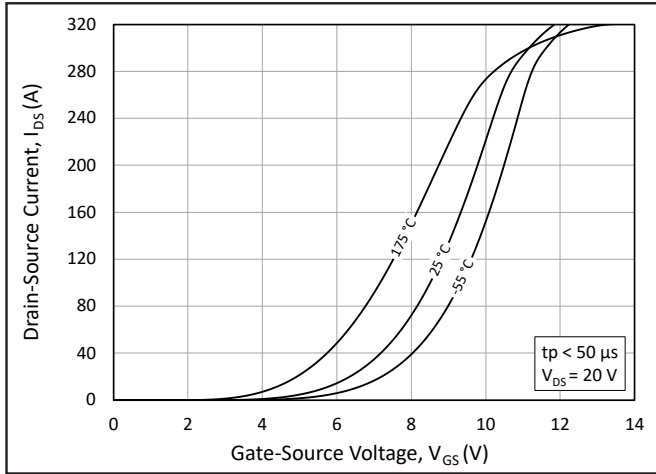

Figure 7. Transfer Characteristic for Various Junction Temperatures

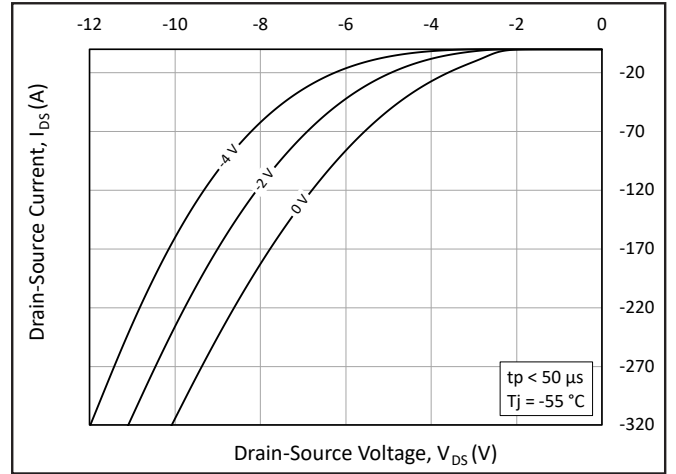

Figure 8. Body Diode Characteristic at -55°C

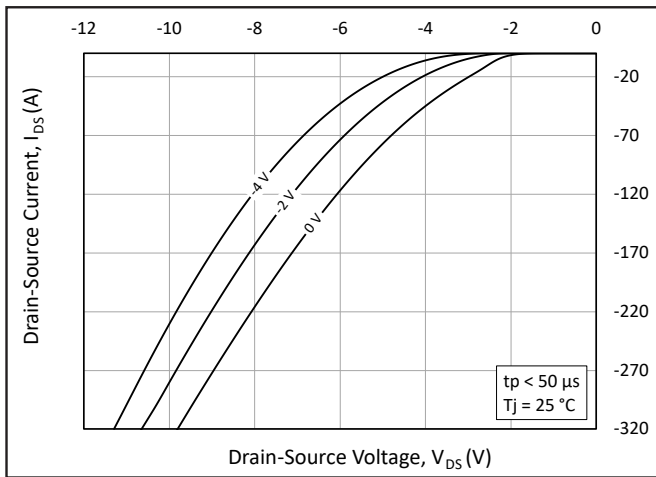

Figure 9. Body Diode Characteristic at 25°C

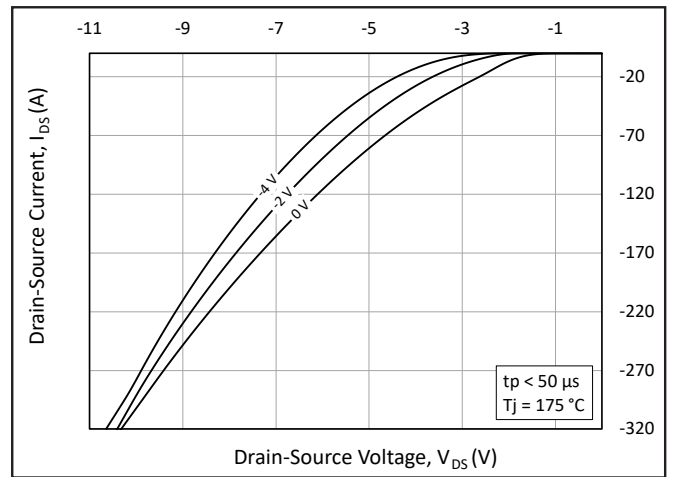

Figure 10. Body Diode Characteristic at 175°C

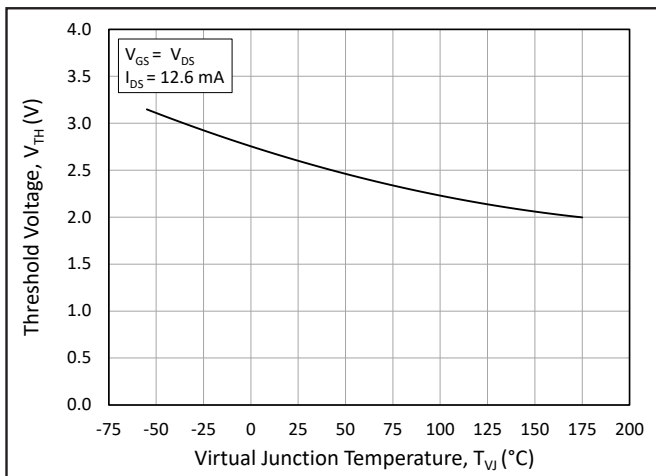

Figure 11. Threshold Voltage vs. Temperature

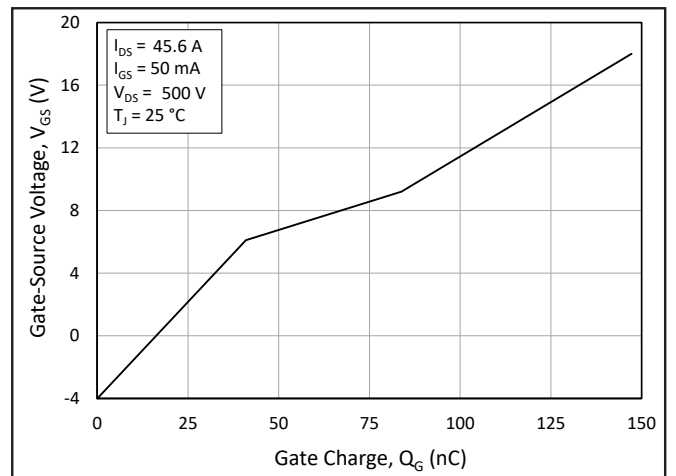

Figure 12. Gate Charge Characteristics



Typical Performance

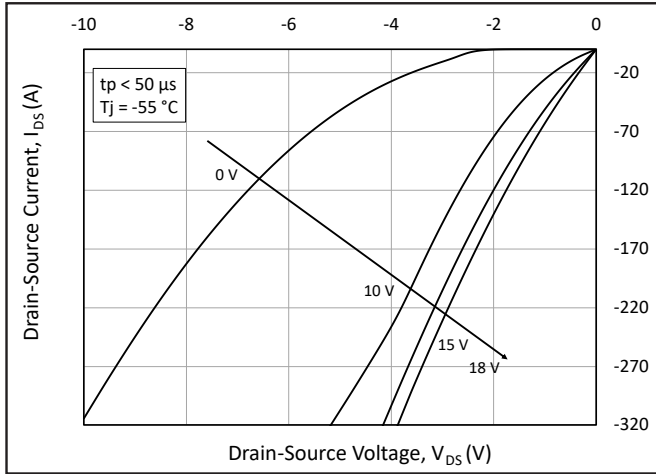

Figure 13. 3rd Quadrant Characteristic at -55°C

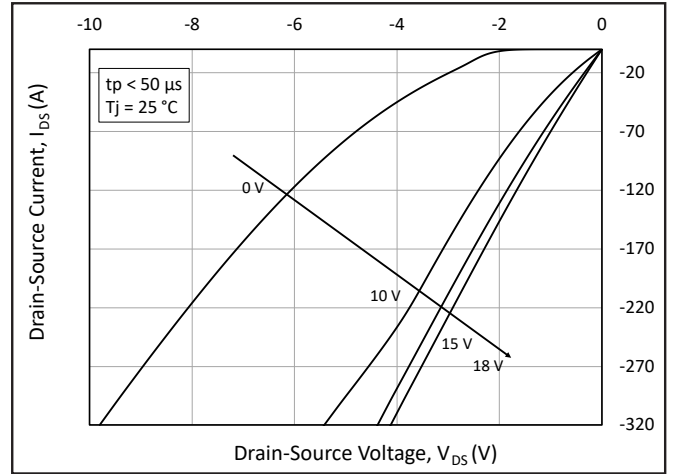

Figure 14. 3rd Quadrant Characteristic at 25°C

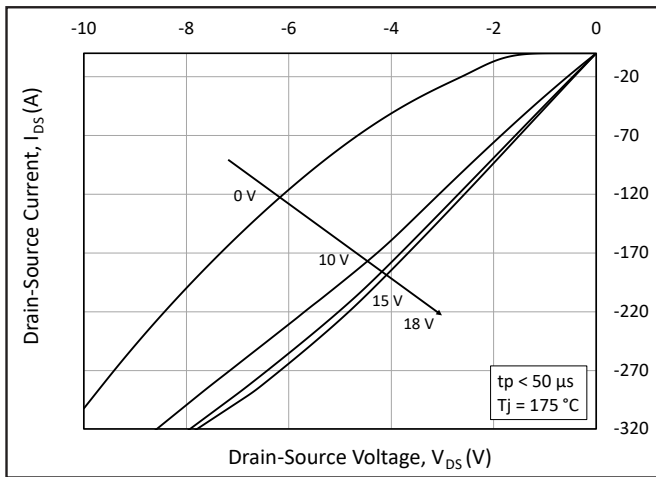

Figure 15. 3rd Quadrant Characteristic at 175°C

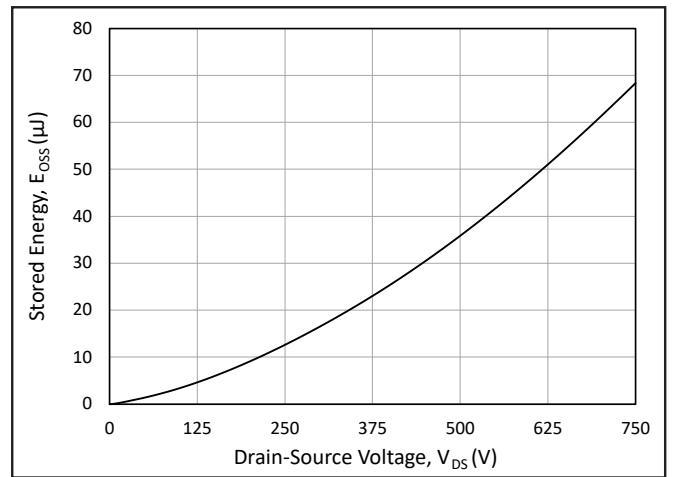

Figure 16. Output Capacitor Stored Energy

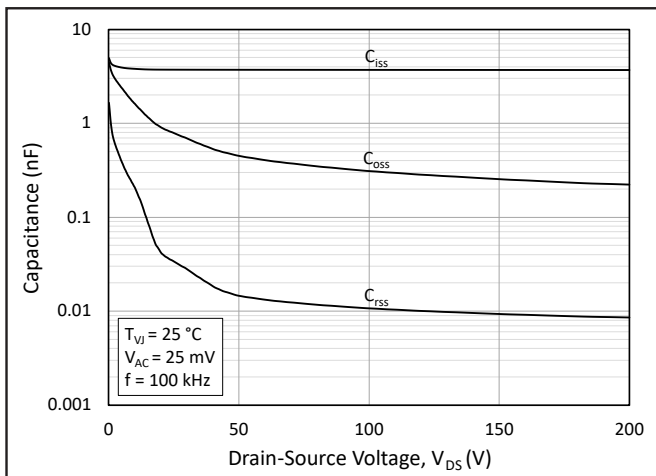

Figure 17. Capacitances vs. Drain-Source Voltage (0 - 200 V)

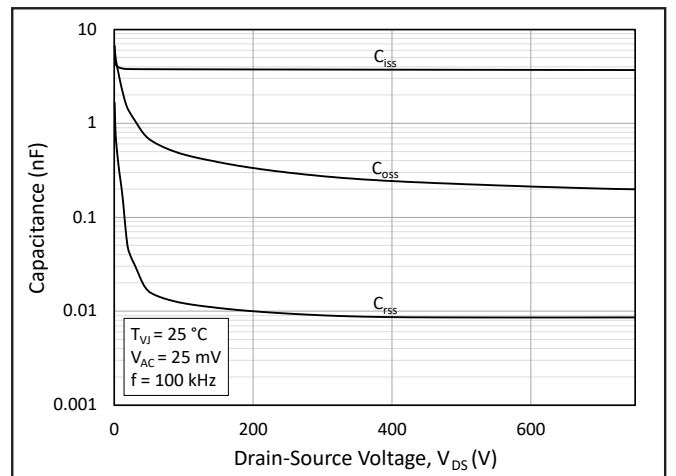

Figure 18. Capacitances vs. Drain-Source Voltage (0 - 750 V)



Typical Performance

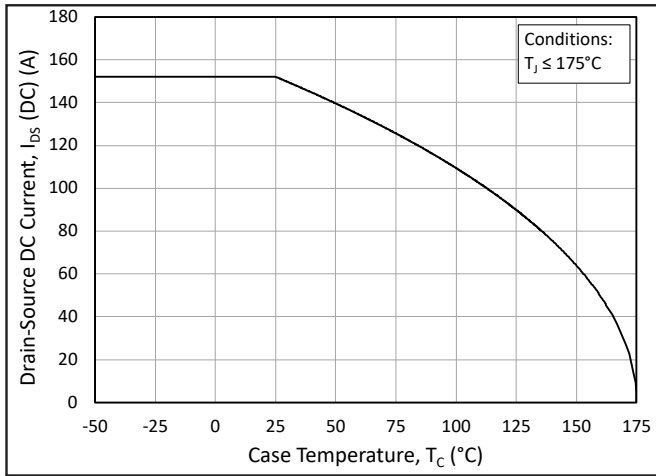

Figure 19. Continuous Drain Current Derating vs. Case Temperature

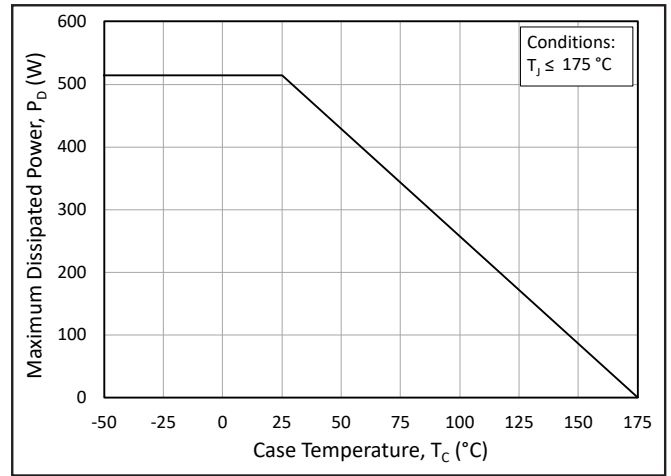

Figure 20. Maximum Power Dissipation Derating vs. Case Temperature

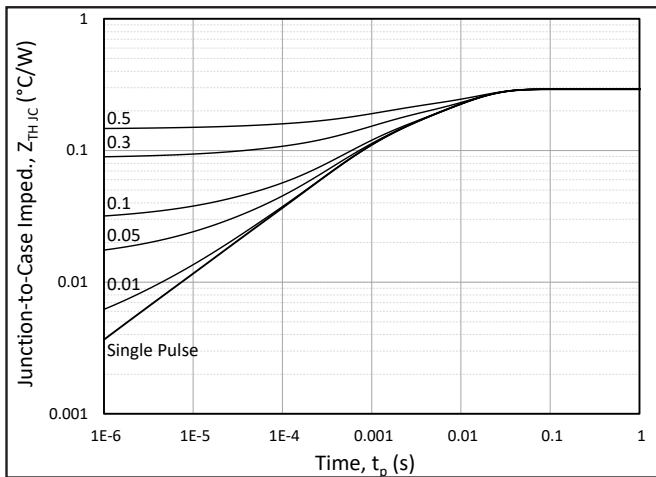

Figure 21. Transient Thermal Impedance (Junction - Case)

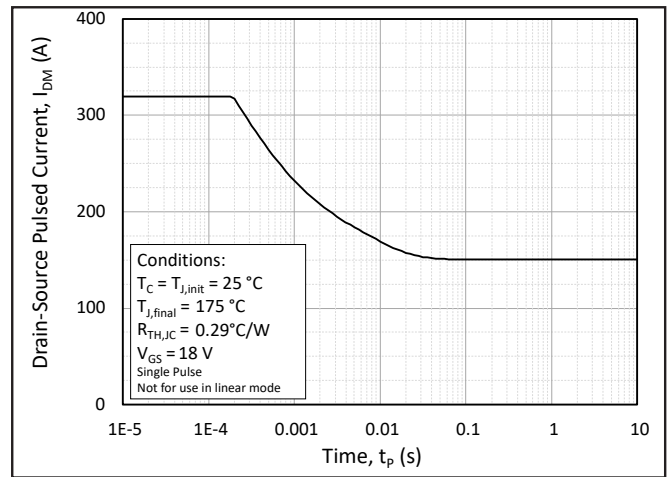

Figure 22. Pulse Current Safe Operating Area

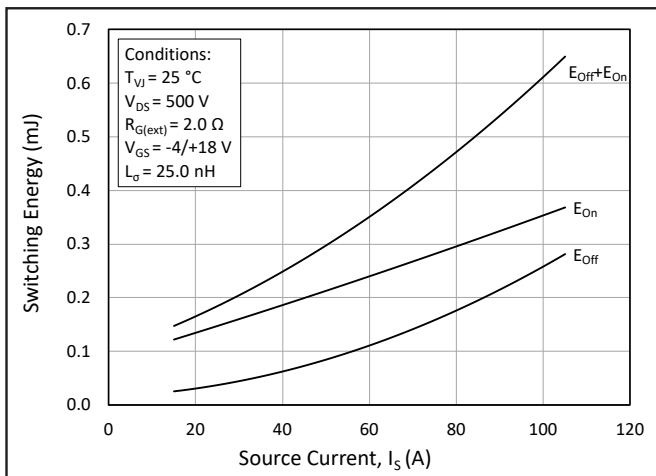

Figure 23. Clamped Inductive Switching Energy vs. Current

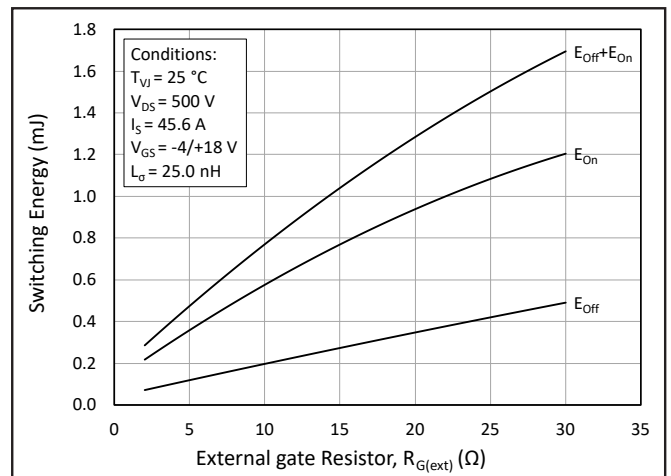

Figure 24. Clamped Inductive Switching Energy vs. $R_{G(ext)}$



Typical Performance

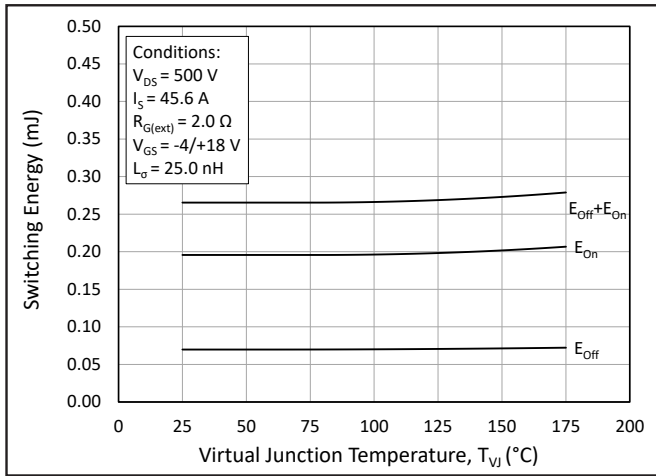

Figure 25. Clamped Inductive Switching Energy vs. Temperature

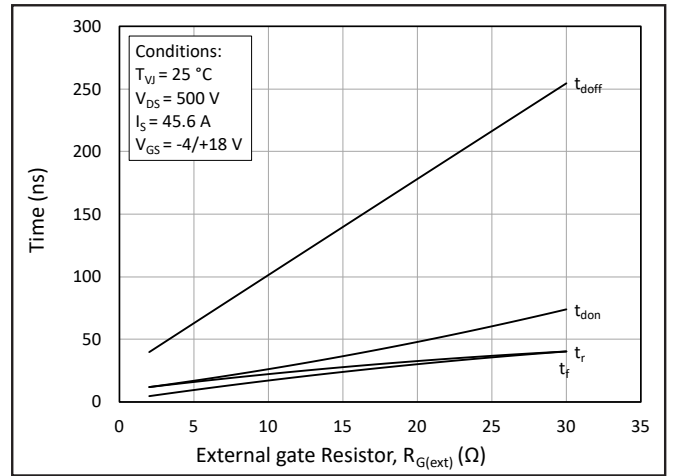

Figure 26. Switching Times vs. $R_{G(ext)}$

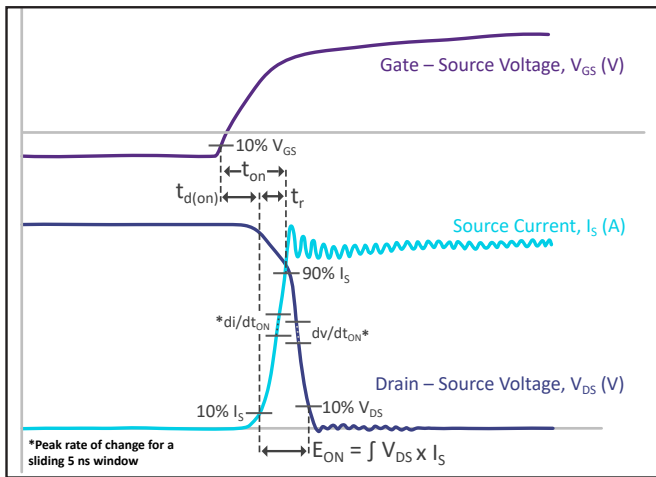

Figure 27. Turn On Switching Times Definition

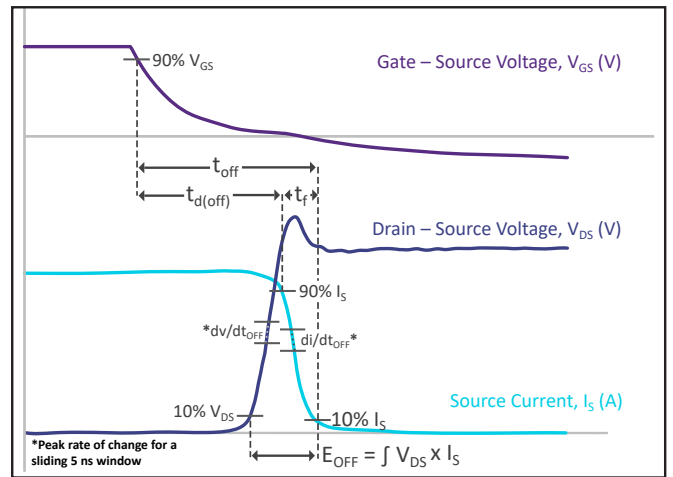

Figure 28. Turn Off Switching Times Definition

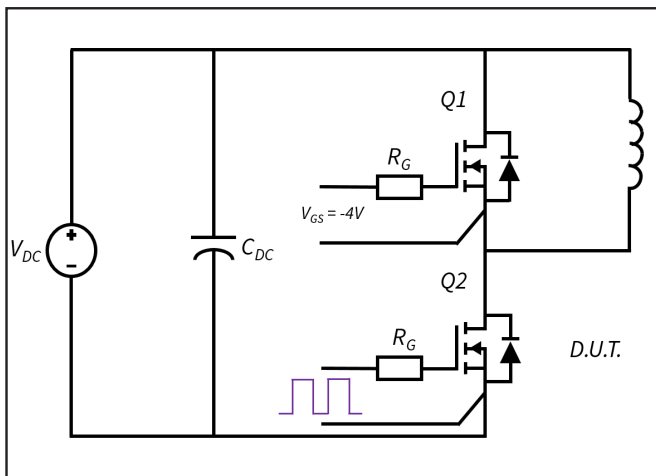

Figure 29. Clamped Inductive MOSFET Switching Waveform Test Circuit

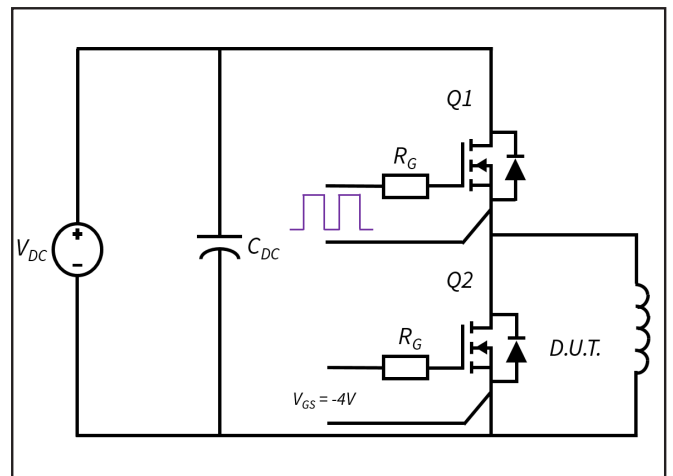
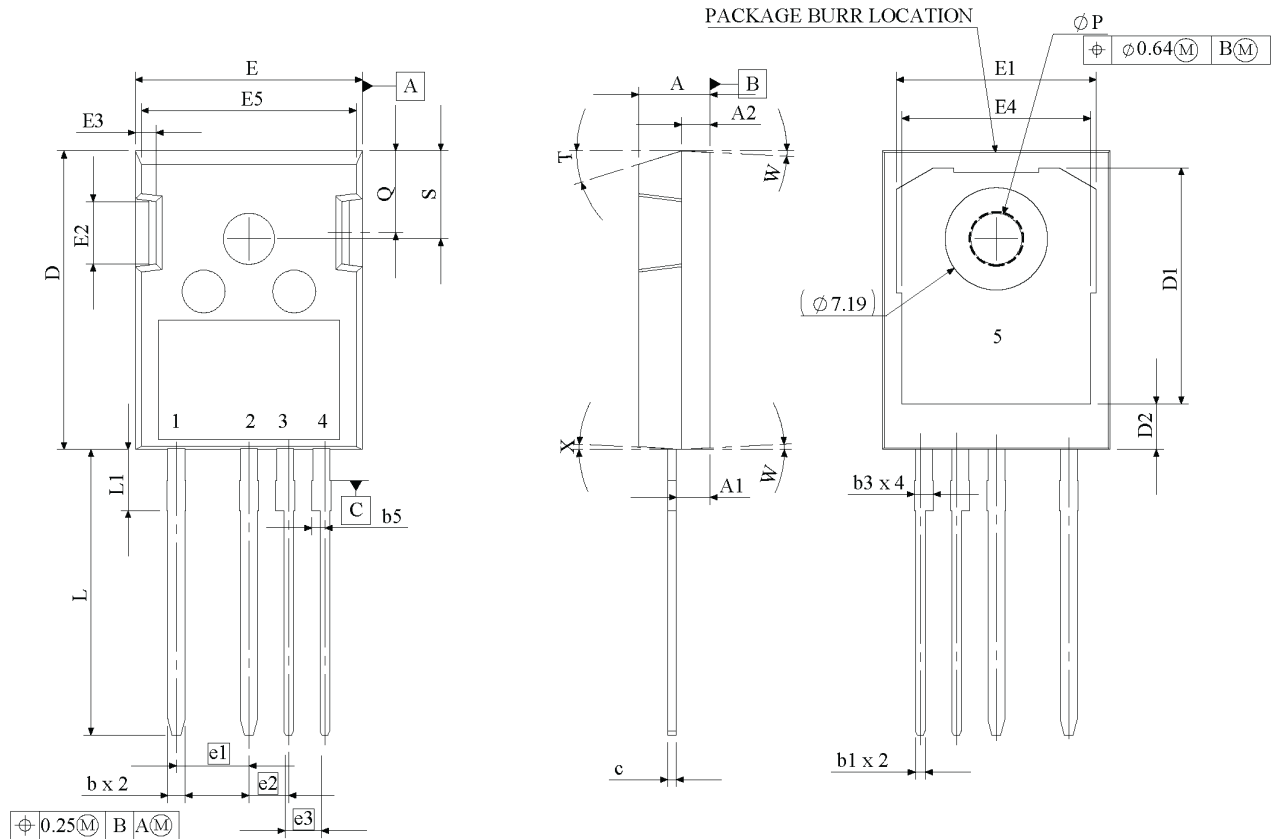

Figure 30. Clamped Inductive Body Diode Switching Waveform Test Circuit

Package Dimensions



SYMBOL	MIN (mm)	MAX (mm)
A	4.83	5.21
A1	2.22	2.6
A2	1.91	2.16
b	1.10	1.30
b1	0.65	0.79
b3	1.34	1.44
b5	0.74	1.14
c	0.55	0.68
D	20.76	21.14
D1	16.25	17.65
D2	2.95	3.35
E	15.75	16.13
E1	13.1	14.15
E2	3.68	5.10
E3	1.00	1.90
E4	12.38	13.43
E5	14.65	15.05
e1	5.08 BSC	
e2	2.79 BSC	
e3	2.54 BSC	
L	19.72	20.32
L1	3.87	4.47
phi P	3.51	3.65
Q	5.49	6.00
S	6.04	6.30
T	17.5° REF.	
W	3.5° REF.	
X	4° REF.	

1	DRAIN
2	SOURCE
3	DRIVER SOURCE
4	GATE
5	DRAIN

NOTE:

1. ALL METAL SURFACES ARE TIN PLATED (MATTE), EXCEPT AREA OF CUT.
2. DIMENSIONING & TOLERANCING CONFORM TO ASME Y14.5M-1994.
3. ALL DIMENSIONS ARE LISTED IN MILLIMETERS. ANGLES ARE IN DEGREES.
4. BURR OR MOLD FLASH SIZE (0.5 mm) IS NOT INCLUDED IN THE DIMENSIONS



Recommended Solder Pad Layout

All dimensions in mm

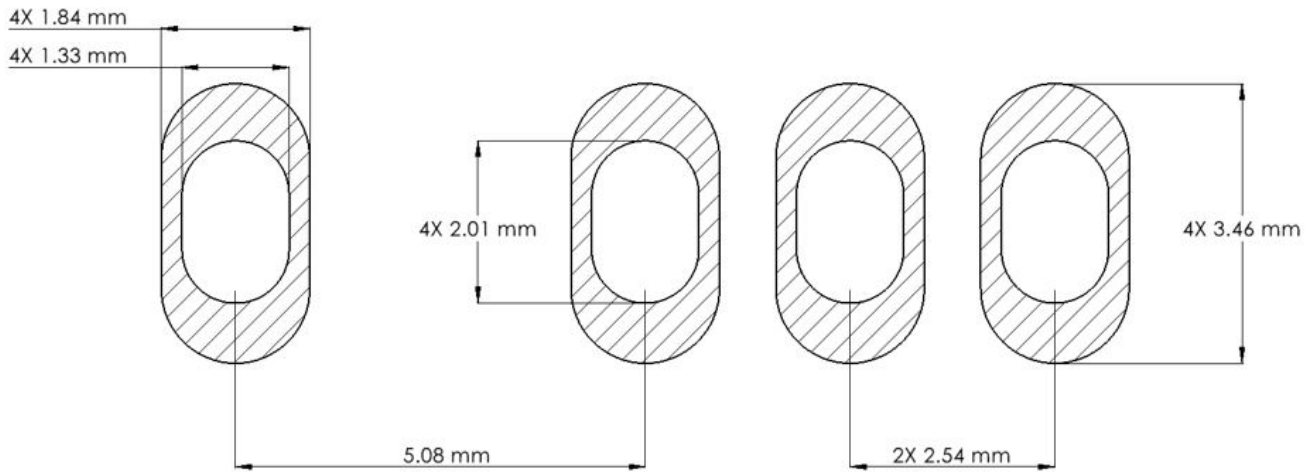



Revision History

Document Version	Date of Change	Description of Changes
1	May 2026	Initial Release
2	June 2026	Updated Figures to -55°C

Appendix

Document Version	Description of Changes
A1	<p>The following are recommendations for turning off the MOSFET with 0 V :</p> <ul style="list-style-type: none"> • Measure the V_{GS} spike accurately using high -CMRR probes and low common mode noise measurements. • For the safe operation of the device, the voltage spike shall remain < 5 V for a time duration of < 40 ns.



Notes & Disclaimers

WOLFSPEED PROVIDES TECHNICAL AND RELIABILITY DATA, DESIGN RESOURCES, APPLICATION OR OTHER DESIGN ADVICE, WEB TOOLS, AND OTHER RESOURCES “AS IS” AND WITH ALL FAULTS, AND DISCLAIMS ALL WARRANTIES, EXPRESS AND IMPLIED, WITH RESPECT THERETO, INCLUDING WITHOUT LIMITATION ANY IMPLIED WARRANTIES OF MERCHANTABILITY, SUITABILITY, FITNESS FOR A PARTICULAR PURPOSE, OR NON-INFRINGEMENT OF THIRD-PARTY INTELLECTUAL PROPERTY RIGHTS.

This document and the information contained herein are subject to change without notice. Any such change shall be evidenced by the publication of an updated version of this document by Wolfspeed. No communication from any employee or agent of Wolfspeed or any third party shall effect an amendment or modification of this document. No responsibility is assumed by Wolfspeed for any infringement of patents or other rights of third parties which may result from use of the information contained herein. No license is granted by implication or otherwise under any patent or patent rights of Wolfspeed.

The information contained in this document (excluding examples, as well as figures or values that are labeled as “typical”) constitutes Wolfspeed’s sole published specifications for the subject product. “Typical” parameters are the average values expected by Wolfspeed in large quantities and are provided for informational purposes only. Any examples provided herein have not been produced under conditions intended to replicate any specific end use. Product performance can and does vary due to a number of factors.

This product has not been designed or tested for use in, and is not intended for use in, any application in which failure of the product would reasonably be expected to cause death, personal injury, or property damage. For purposes of (but without limiting) the foregoing, this product is not designed, intended, or authorized for use as a critical component in equipment implanted into the human body, life-support machines, cardiac defibrillators, and similar emergency medical equipment; air traffic control systems; or equipment used in the planning, construction, maintenance, or operation of nuclear facilities. Notwithstanding any application-specific information, guidance, assistance, or support that Wolfspeed may provide, the buyer of this product is solely responsible for determining the suitability of this product for the buyer’s purposes, including without limitation (1) selecting the appropriate Wolfspeed products for the buyer’s application, (2) designing, validating, and testing the buyer’s application, and (3) ensuring the buyer’s application meets applicable standards and any other legal, regulatory, and safety-related requirements.

RoHS Compliance

The levels of RoHS restricted materials in this product are below the maximum concentration values (also referred to as the threshold limits) permitted for such substances, or are used in an exempted application, in accordance with EU Directive 2011/65/EC (RoHS2), as implemented January 2, 2013. RoHS Declarations for this product can be obtained from your Wolfspeed representative or from the Product Documentation sections of www.wolfspeed.com.

REACH Compliance

REACH substances of high concern (SVHCs) information is available for this product. Since the European Chemical Agency (ECHA) has published notice of their intent to frequently revise the SVHC listing for the foreseeable future, please contact your Wolfspeed representative to ensure you get the most up-to-date REACH SVHC Declaration. REACH banned substance information (REACH Article 67) is also available upon request.

Contact info:

4600 Silicon Drive
Durham, NC 27703 USA
Tel: +1.919.313.5300
www.wolfspeed.com/power