

# C4MV045065T

## 650V 45mΩ VGS Optimized Silicon Carbide Power MOSFET N-Channel Enhancement Mode

### Features

- Industry compatible drive voltage +15V..18V
- Industry standard Top Side Cooled (TSC) package
- High power dissipation capability
- Optimized package with separate driver source pin
- High-speed switching with low capacitances
- Soft body diode to minimize voltage overshoots
- Halogen free, RoHS compliant

### Benefits

- Compatible with industry standard gate drivers
- Increase power density
- Reduce cooling requirements
- Reduce switching losses and minimize gate ringing
- Higher system efficiency
- Increase system switching frequency

### Applications

- EV Chargers
- Solar/ESS
- Motor Control
- Industrial Power Supplies
- High Voltage DC/DC Converters

### Package

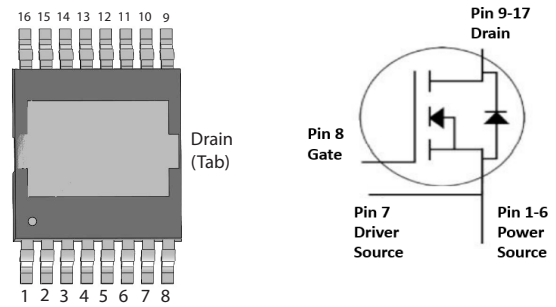

Orderable Part Number	Package	Marking
C4MV045065T-TR	TOLT (TSC)	C4MV045065T

### Key Parameters

Parameter	Symbol	Min.	Typ.	Max	Unit	Conditions	Note
Drain - Source Voltage	$V_{DS}$			650	V	$T_c = 25^\circ\text{C}$	
Maximum Gate - Source Voltage (Transient)	$V_{GS}$	-10		+23		Transient	Refer to PRD-04814
DC Continuous Drain Current	$I_D$		51		A	$V_{GS} = 18\text{V}, T_c = 25^\circ\text{C}, T_J \leq 175^\circ\text{C}$	Fig 19 Note 1
			36			$V_{GS} = 18\text{V}, T_c = 100^\circ\text{C}, T_J \leq 175^\circ\text{C}$	
Pulsed Drain Current	$I_{DM}$			123		$t_{pmax}$ limited by $T_{jmax}$ $V_{GS} = 18\text{V}, T_c = 25^\circ\text{C}$	Fig 22
Power Dissipation	$P_D$		206		W	$T_c = 25^\circ\text{C}, T_J = 175^\circ\text{C}$	Fig 20
Operating Junction and Storage Temperature	$T_J, T_{stg}$	-55		175	$^\circ\text{C}$		
Solder Temperature	$T_L$			260		According to JEDEC J-STD-020	

Note (1): Verified by Design

Electrical Characteristics ( $T_c = 25^\circ\text{C}$  unless otherwise specified)

Symbol	Parameter	Min.	Typ.	Max.	Unit	Test Conditions	Note
$V_{(BR)DSS}$	Drain-Source Breakdown Voltage	650				$V_{GS} = 0\text{ V}, I_D = 100\ \mu\text{A}$	
$V_{GS(th)}$	Gate Threshold Voltage	1.8	2.6	3.8	V	$V_{DS} = V_{GS}, I_D = 4.84\ \text{mA}$	Fig. 11
			2.2			$V_{DS} = V_{GS}, I_D = 4.84\ \text{mA}, T_J = 175^\circ\text{C}$	
$I_{DSS}$	Zero Gate Voltage Drain Current		1	50	$\mu\text{A}$	$V_{DS} = 650\ \text{V}, V_{GS} = 0\ \text{V}$	
$I_{GSS}$	Gate-Source Leakage Current		10	250	nA	$V_{GS} = 18\ \text{V}, V_{DS} = 0\ \text{V}$	
$V_{GS(op)}$	Recommended Turn On Gate-Source Voltage		+15..+18		V		Refer to PRD-09634
	Recommended Turn Off Gate-Source Voltage		-5..0				
$R_{DS(on)}$	Drain-Source On-State Resistance		45	58	m $\Omega$	$V_{GS} = 18\ \text{V}, I_D = 17.6\ \text{A}$	Fig. 4, 5, 6
			70			$V_{GS} = 18\ \text{V}, I_D = 17.6\ \text{A}, T_J = 175^\circ\text{C}$	
			56			$V_{GS} = 15\ \text{V}, I_D = 17.6\ \text{A}$	
$g_{fs}$	Transconductance		13		S	$V_{DS} = 20\ \text{V}, I_{DS} = 17.6\ \text{A}$	Fig. 7
			13			$V_{DS} = 20\ \text{V}, I_{DS} = 17.6\ \text{A}, T_J = 175^\circ\text{C}$	
$C_{iss}$	Input Capacitance		1342		pF	$V_{GS} = 0\ \text{V}, V_{DS} = 0\ \text{V to } 400\ \text{V}$ $f = 100\ \text{kHz}$ $V_{AC} = 25\ \text{mV}$	Fig. 17, 18
$C_{oss}$	Output Capacitance		106				
$C_{rss}$	Reverse Transfer Capacitance		10				
$E_{oss}$	$C_{oss}$ Stored Energy		10		$\mu\text{J}$		Fig. 16
$C_{o(er)}$	Effective Output Capacitance (Energy Related)		135		pF	$V_{GS} = 0\ \text{V}, V_{DS} = 0\ \dots\ 400\ \text{V}$	Note: 2
$C_{o(tr)}$	Effective Output Capacitance (Time Related)		189				
$E_{oN}$	Turn-On Switching Energy (MOSFET FWD)		37		$\mu\text{J}$	$V_{DS} = 400\ \text{V}, V_{GS} = -4\ \text{V}/18\ \text{V}, I_D = 17.6\ \text{A},$ $R_{G(ext)} = 2\ \Omega, L = 63\ \mu\text{H}, T_J = 175^\circ\text{C}$ FWD = Internal Body Diode	
$E_{oFF}$	Turn-Off Switching Energy (MOSFET FWD)		9				
$t_{d(on)}$	Turn-On Delay Time		8		ns	$V_{DD} = 400\ \text{V}, V_{GS} = -4\ \text{V}/18\ \text{V}$ $I_D = 17.6\ \text{A}, R_{G(ext)} = 2\ \Omega,$ Timing relative to $V_{DS}$ Inductive load	
$t_r$	Rise Time		3				
$t_{d(off)}$	Turn-Off Delay Time		20				
$t_f$	Fall Time		9				
$R_{G(int)}$	Internal Gate Resistance		2.6		$\Omega$	$f = 1\ \text{MHz}$	
$Q_{gs}$	Gate to Source Charge		15		nC	$V_{DS} = 400\ \text{V}, V_{GS} = -4\ \text{V}/18\ \text{V}$ $I_D = 17.6\ \text{A}$ Per IEC60747-8-4 pg 21	Fig. 12
$Q_{gd}$	Gate to Drain Charge		16				
$Q_g$	Total Gate Charge		58				

Note (2):  $C_{o(er)}$ , a lumped capacitance that gives same stored energy as  $C_{oss}$  while  $V_{ds}$  is rising from 0 to 400V

$C_{o(tr)}$ , a lumped capacitance that gives same charging time as  $C_{oss}$  while  $V_{ds}$  is rising from 0 to 400V

Reverse Diode Characteristics ( $T_c = 25^\circ\text{C}$  unless otherwise specified)

Symbol	Parameter	Typ.	Max.	Unit	Test Conditions	Note
$V_{SD}$	Diode Forward Voltage	4.9		V	$V_{GS} = -4\text{ V}, I_{SD} = 8.8\text{ A}, T_J = 25^\circ\text{C}$	Fig. 8, 9, 10
		4.2			$V_{GS} = -4\text{ V}, I_{SD} = 8.8\text{ A}, T_J = 175^\circ\text{C}$	
$I_S$	Continuous Diode Forward Current		33	A	$V_{GS} = -4\text{ V}, T_C = 25^\circ\text{C}$	
$I_{SM}$	Diode pulse Current		123		$V_{GS} = -4\text{ V}$ , pulse width $t_p$ limited by $T_{Jmax}$	
$t_{rr}$	Reverse Recovery time	10		ns	$V_{GS} = -4\text{ V}, I_{SD} = 17.6\text{ A}, V_R = 400\text{ V}$ $dif/dt = 7495\text{ A}/\mu\text{s}, T_J = 175^\circ\text{C}$	
$Q_{rr}$	Reverse Recovery Charge	262		nC		
$I_{rrm}$	Peak Reverse Recovery Current	44		A		
$t_{rr}$	Reverse Recovery time	40		ns	$V_{GS} = -4\text{ V}, I_{SD} = 17.6\text{ A}, V_R = 400\text{ V}$ $dif/dt = 1216\text{ A}/\mu\text{s}, T_J = 175^\circ\text{C}$	
$Q_{rr}$	Reverse Recovery Charge	161		nC		
$I_{rrm}$	Peak Reverse Recovery Current	9		A		

## Thermal Characteristics

Symbol	Parameter	Typ.	Unit	Test Conditions	Note
$R_{\theta JC}$	Thermal Resistance from Junction to Case	0.56	$^\circ\text{C}/\text{W}$		Fig. 21



Typical Performance

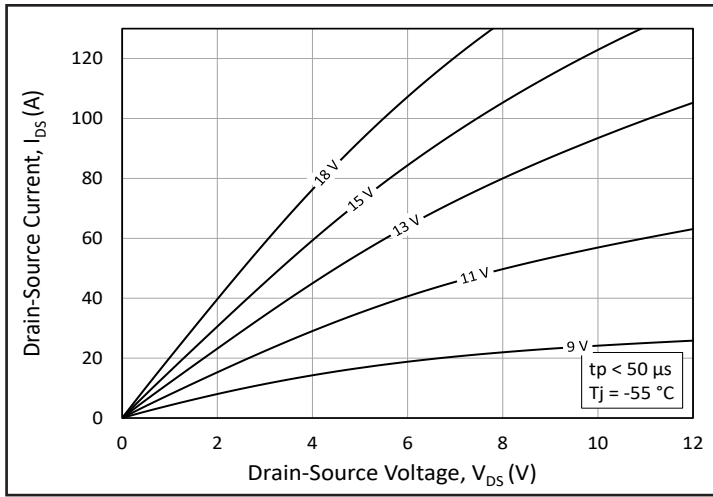

Figure 1. Output Characteristics  $T_j = -55\text{ }^\circ\text{C}$

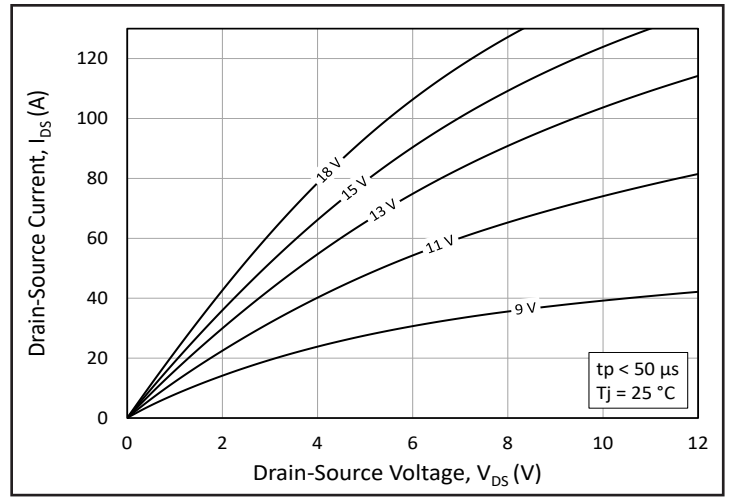

Figure 2. Output Characteristics  $T_j = 25\text{ }^\circ\text{C}$

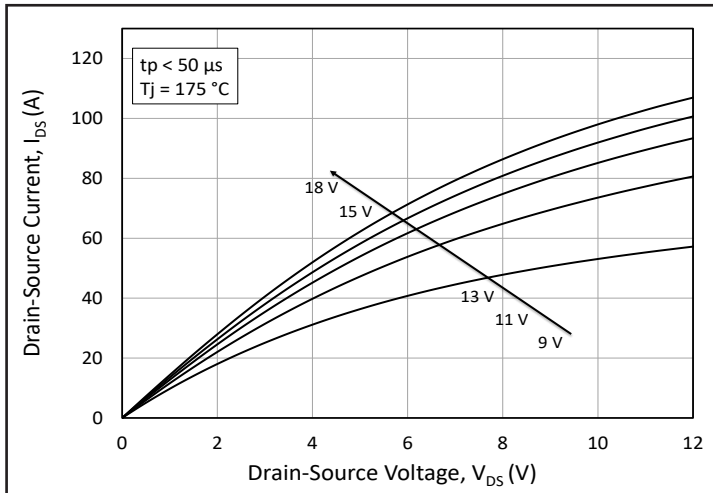

Figure 3. Output Characteristics  $T_j = 175\text{ }^\circ\text{C}$

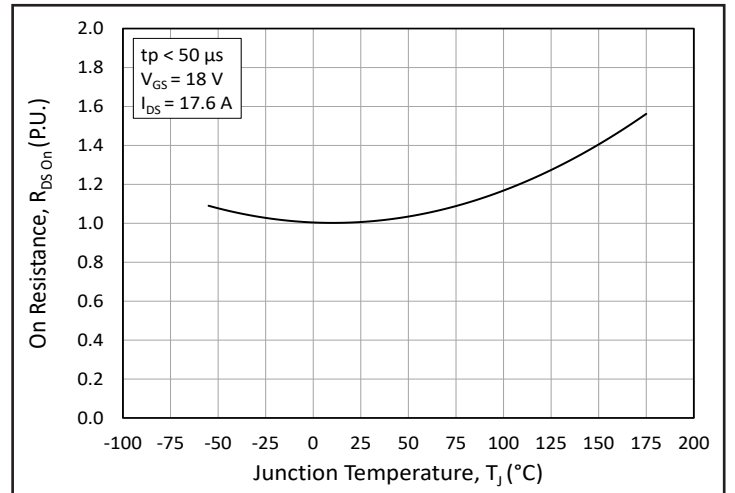

Figure 4. Normalized On-Resistance vs. Temperature

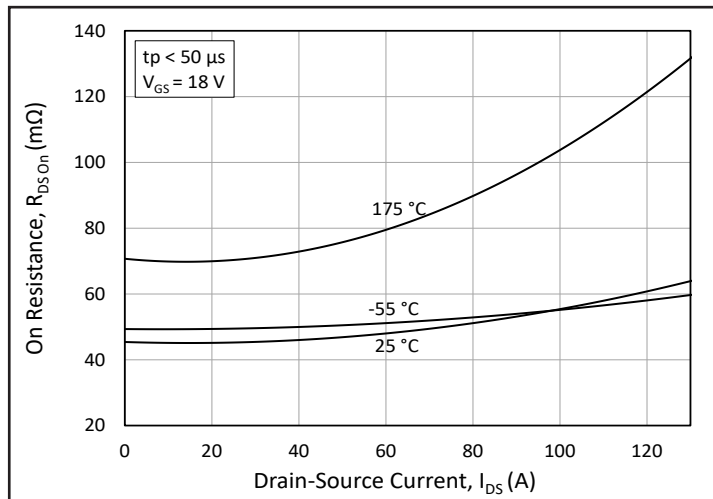

Figure 5. On-Resistance vs. Drain Current For Various Temperatures

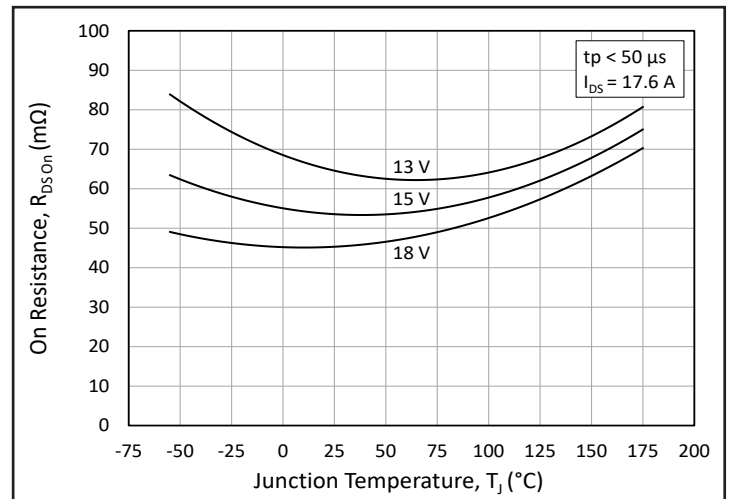

Figure 6. On-Resistance vs. Temperature For Various Gate Voltage



Typical Performance

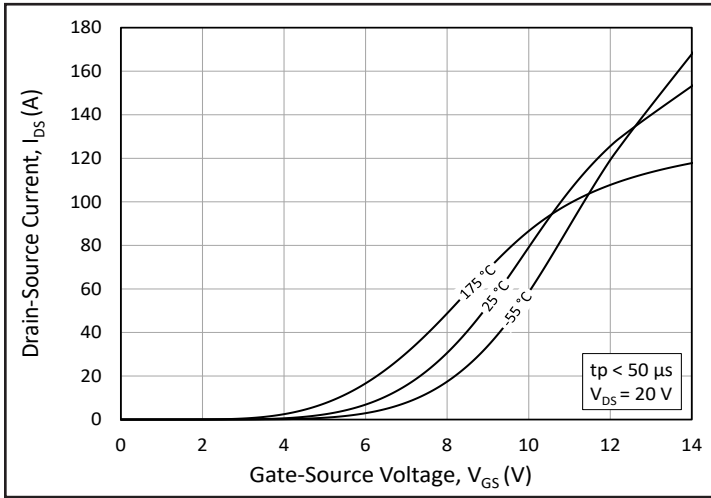

Figure 7. Transfer Characteristic for Various Junction Temperatures

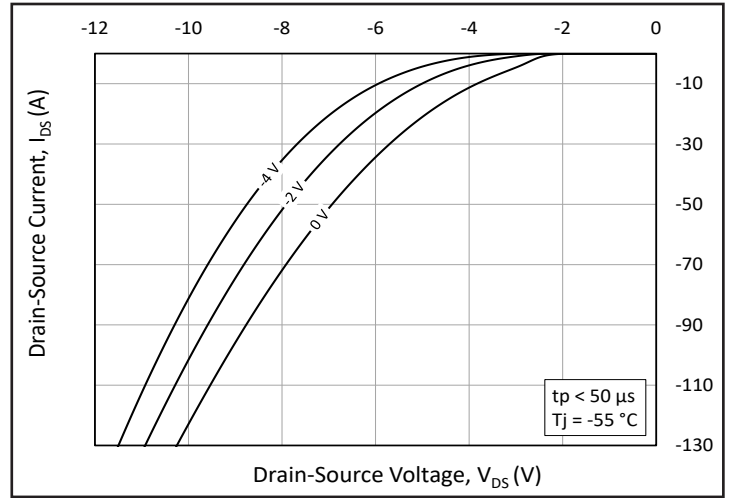

Figure 8. Body Diode Characteristic at -55 °C

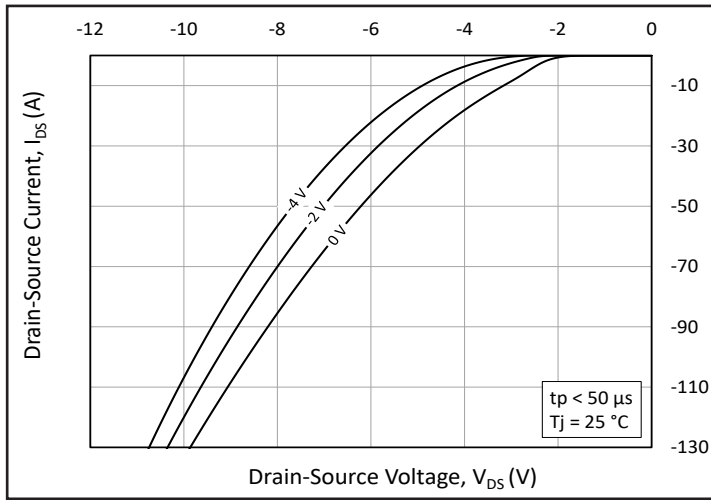

Figure 9. Body Diode Characteristic at 25 °C

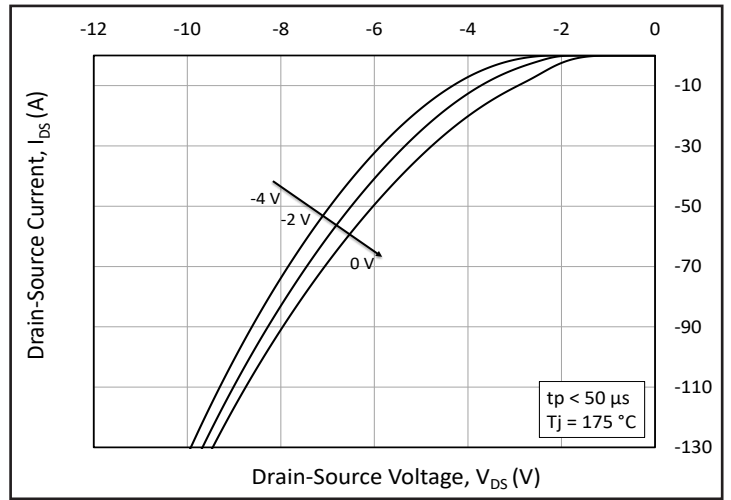

Figure 10. Body Diode Characteristic at 175 °C

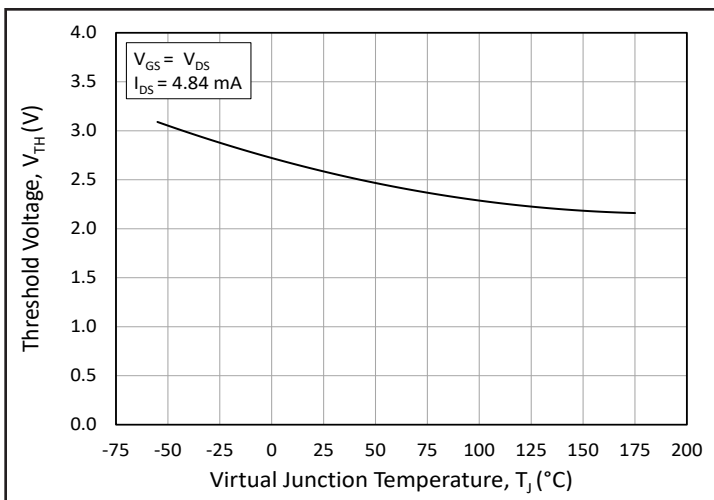

Figure 11. Threshold Voltage vs. Temperature

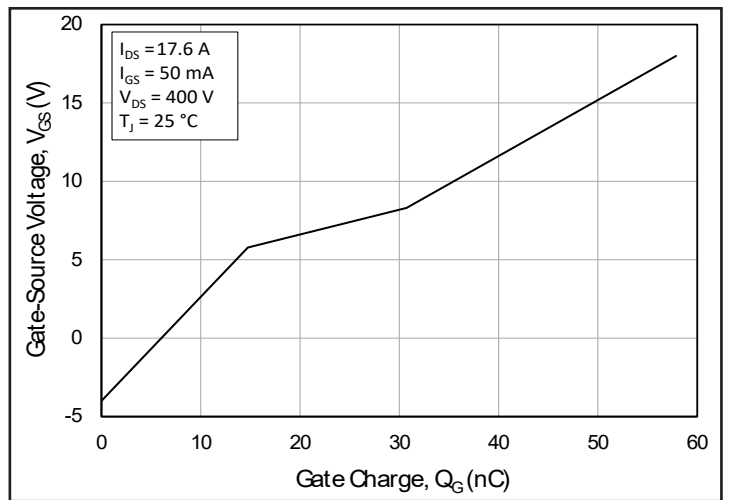

Figure 12. Gate Charge Characteristics



Typical Performance

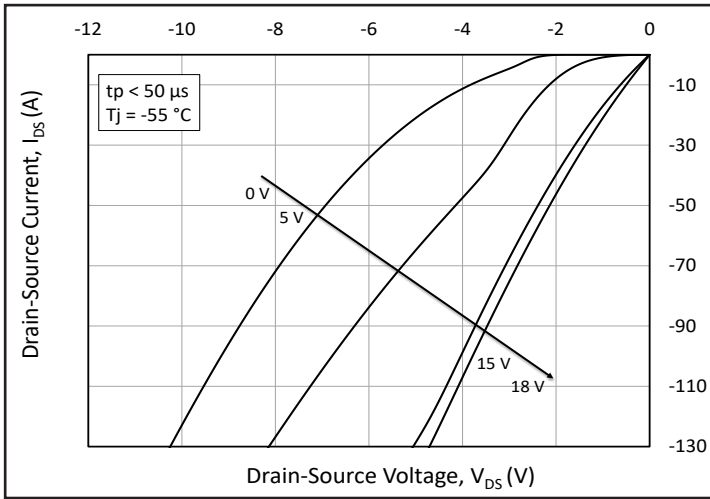

Figure 13. 3rd Quadrant Characteristic at -55 °C

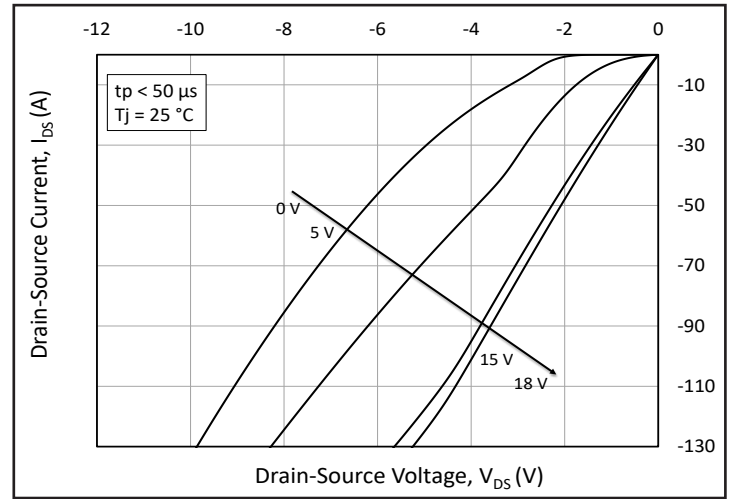

Figure 14. 3rd Quadrant Characteristic at 25 °C

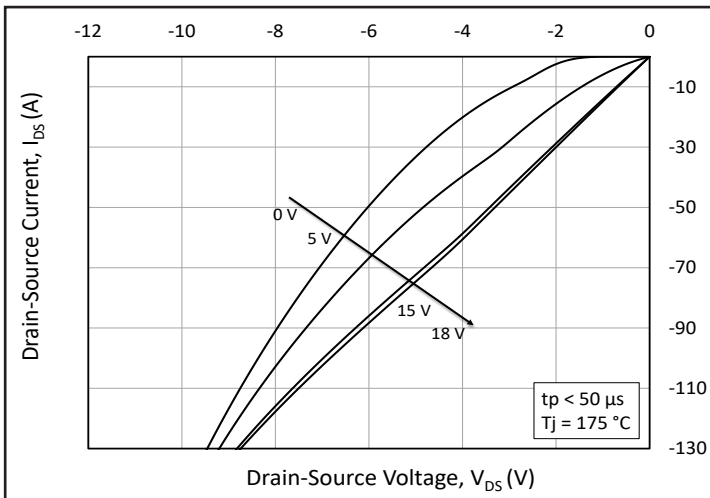

Figure 15. 3rd Quadrant Characteristic at 175 °C

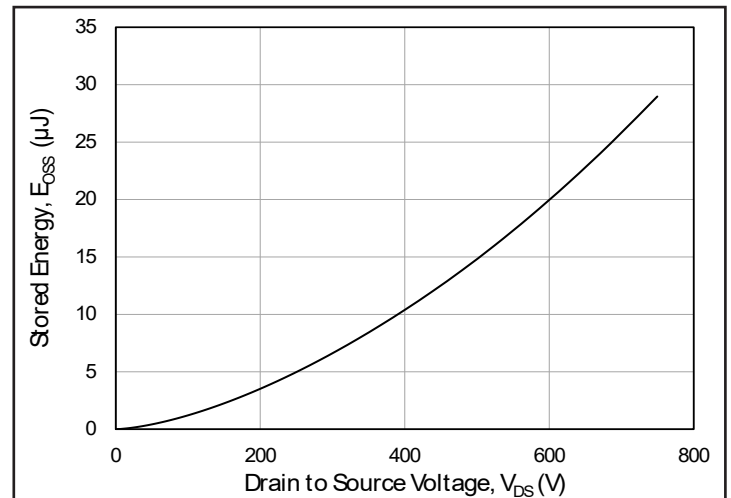

Figure 16. Output Capacitor Stored Energy

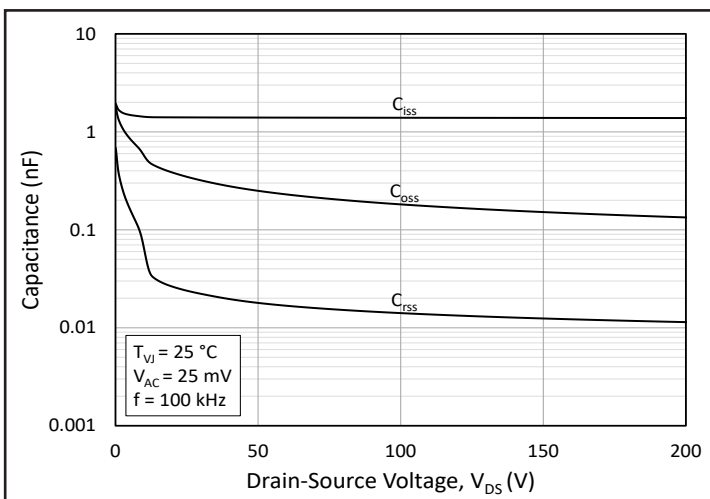

Figure 17. Capacitances vs. Drain-Source Voltage (0 - 200V)

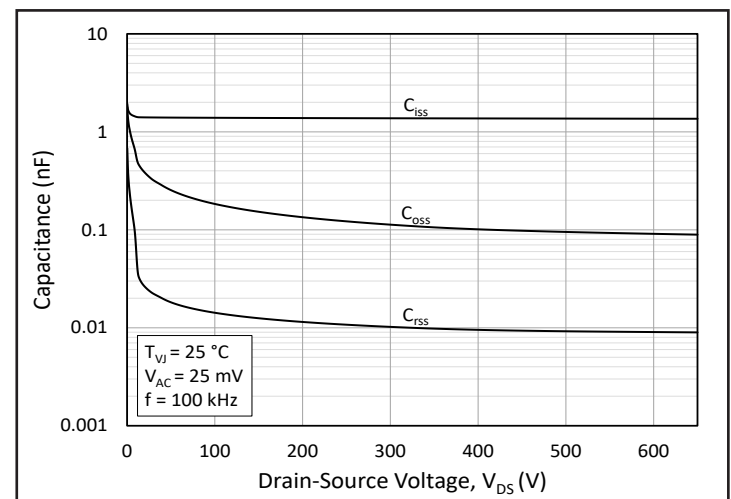

Figure 18. Capacitances vs. Drain-Source Voltage (0 - 650V)



Typical Performance

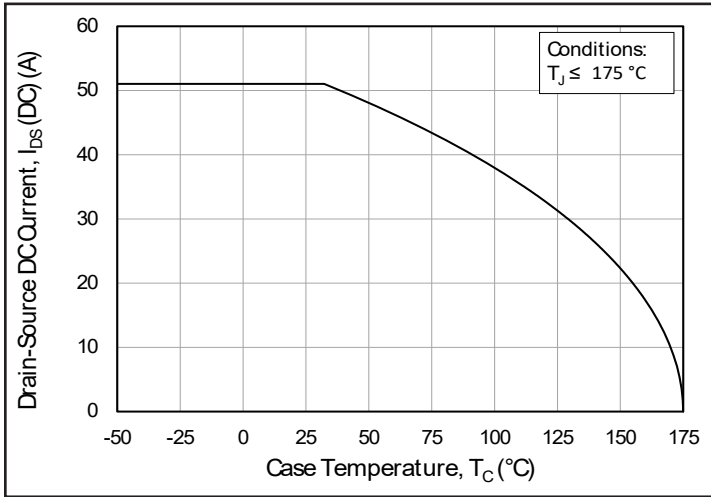

Figure 19. Continuous Drain Current Derating vs. Case Temperature

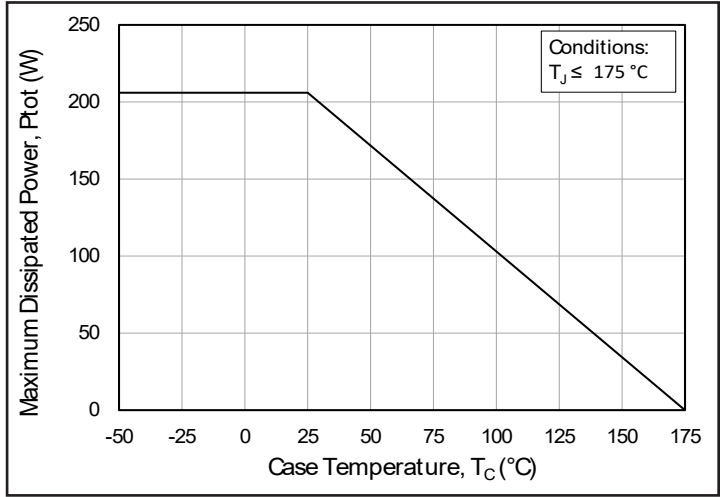

Figure 20. Maximum Power Dissipation Derating vs. Case Temperature

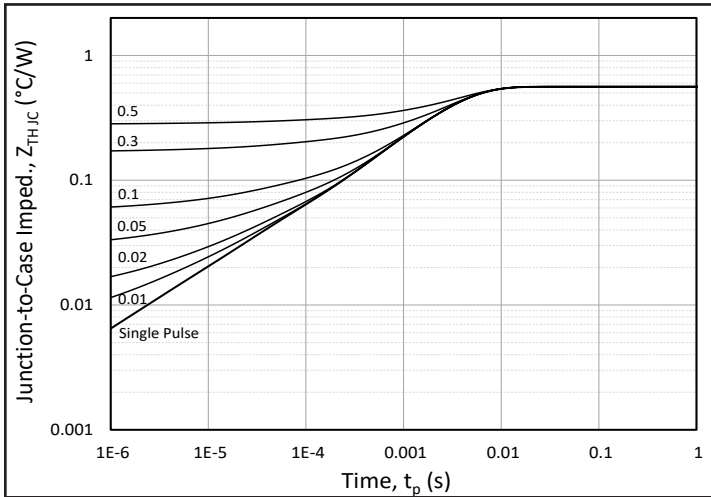

Figure 21. Transient Thermal Impedance (Junction - Case)

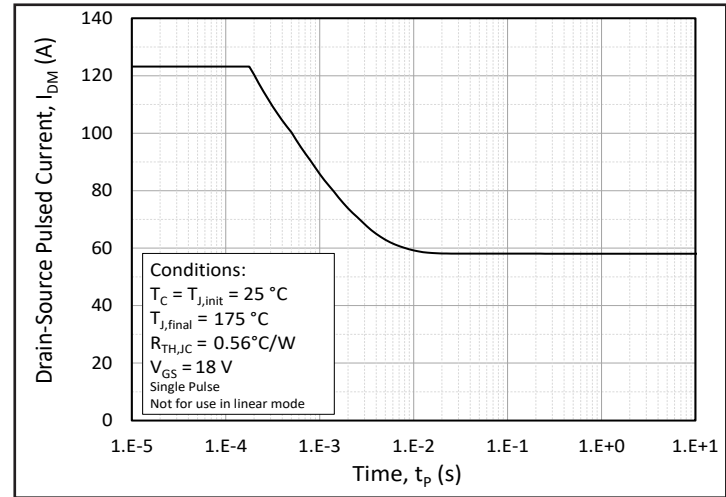

Figure 22. Safe Operating Area

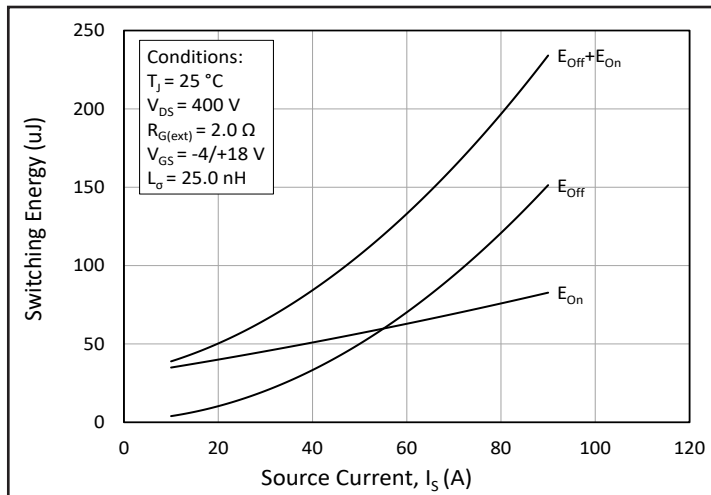

Figure 23. Clamped Inductive Switching Energy vs. Drain Current ( $V_{DD} = 400V$ )

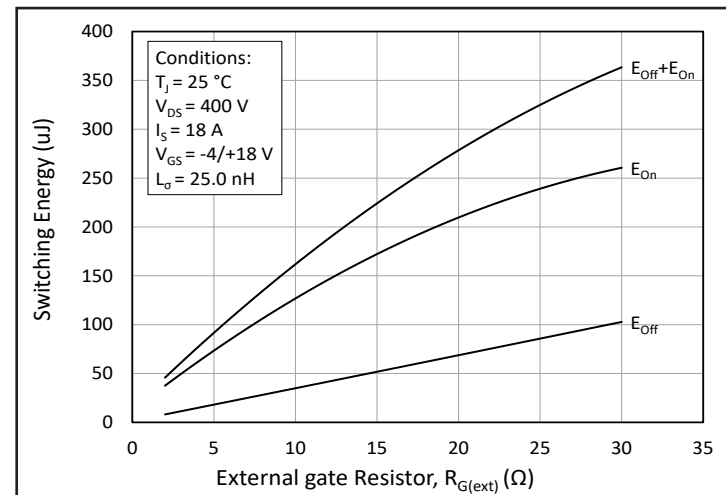

Figure 24. Clamped Inductive Switching Energy vs.  $R_{G(ext)}$



Typical Performance

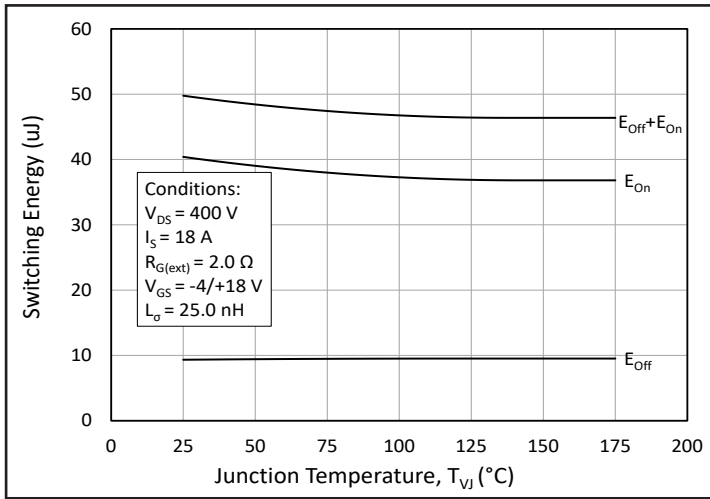

Figure 25. Clamped Inductive Switching Energy vs. Temperature

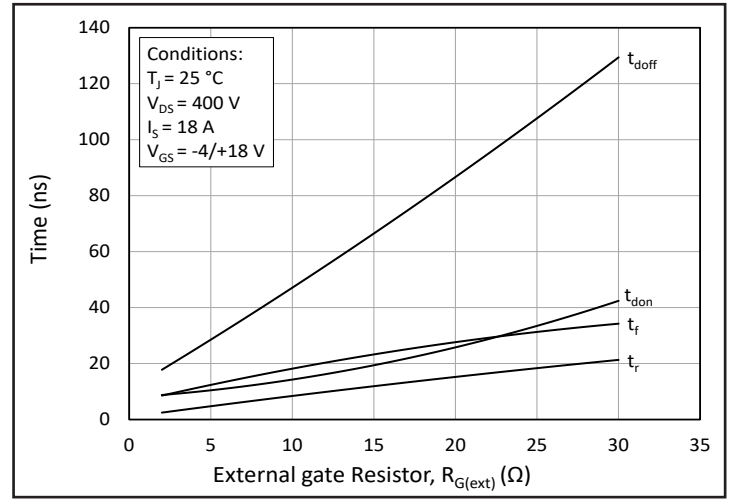

Figure 26. Switching Times vs.  $R_{G(ext)}$

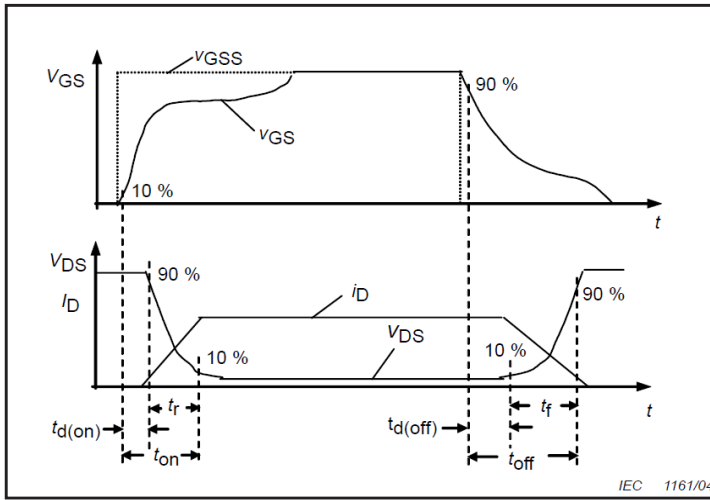

Figure 27. Switching Times Definition

## Test Circuit Schematic

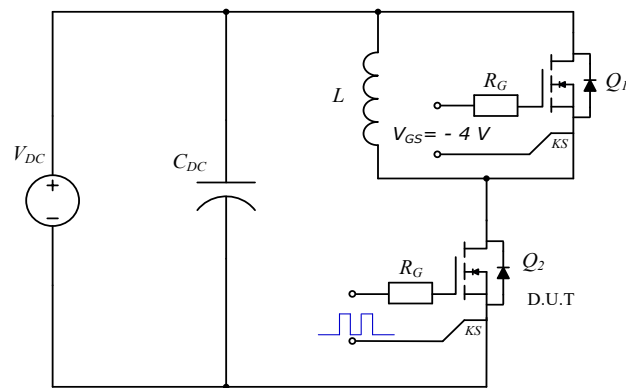
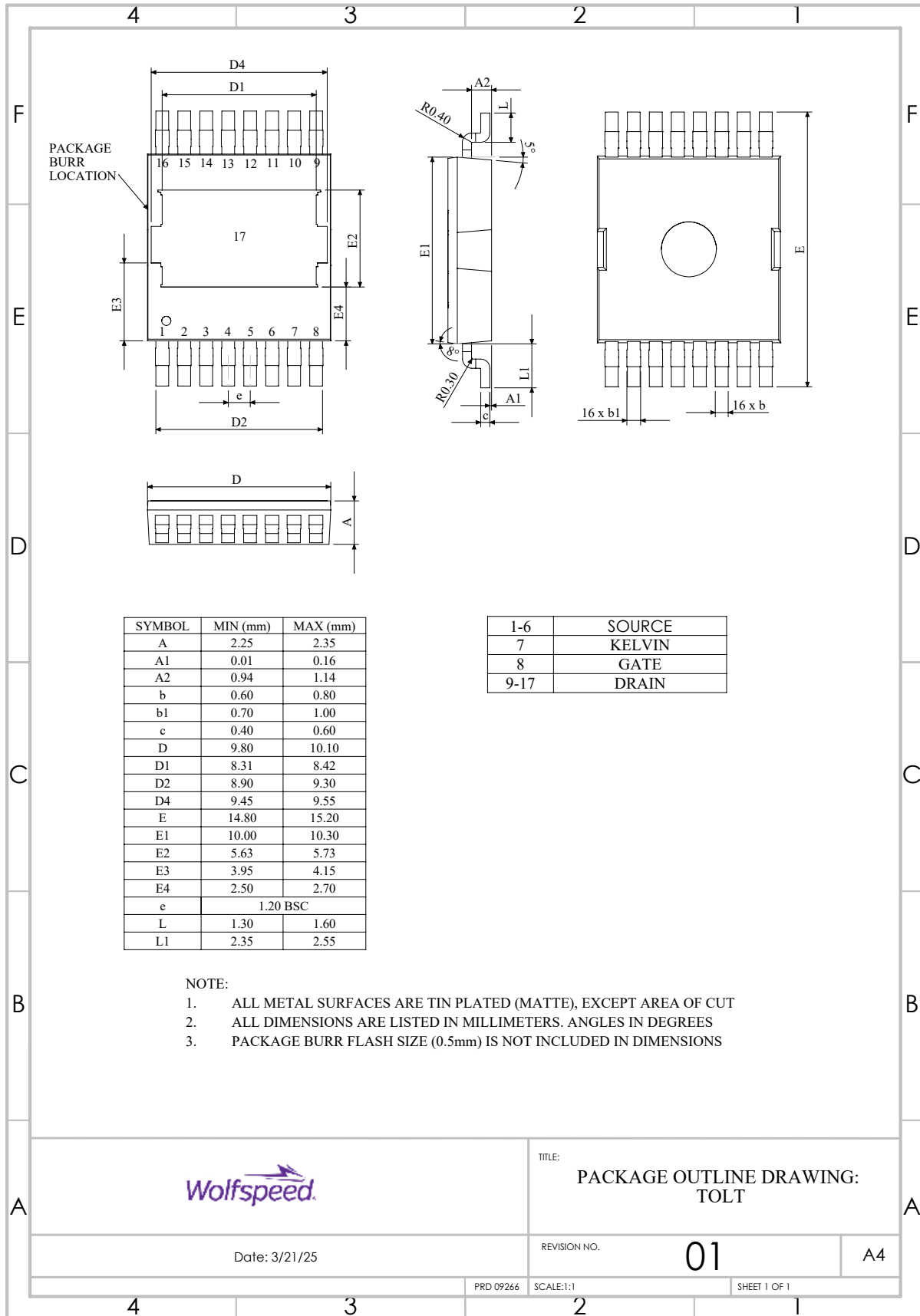

Figure 28. Clamped Inductive Switching  
Waveform Test Circuit

Package Dimensions





### Recommended Solder Pad Layout

All dimensions in mm

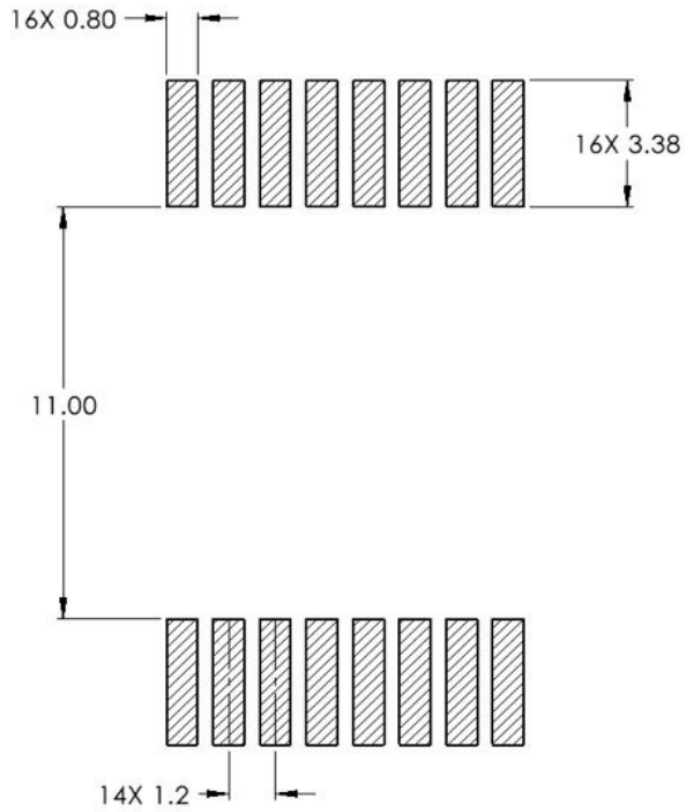



## Revision history

---

Document Version	Date of release	Description of changes
1	January 2026	Initial release
2	January 2026	Updated Fig 25 and Eon values in Table 2



## Notes & Disclaimer

---

WOLFSPEED PROVIDES TECHNICAL AND RELIABILITY DATA, DESIGN RESOURCES, APPLICATION OR OTHER DESIGN ADVICE, WEB TOOLS, AND OTHER RESOURCES “AS IS” AND WITH ALL FAULTS, AND DISCLAIMS ALL WARRANTIES, EXPRESS AND IMPLIED, WITH RESPECT THERETO, INCLUDING WITHOUT LIMITATION ANY IMPLIED WARRANTIES OF MERCHANTABILITY, SUITABILITY, FITNESS FOR A PARTICULAR PURPOSE, OR NON-INFRINGEMENT OF THIRD-PARTY INTELLECTUAL PROPERTY RIGHTS.

This document and the information contained herein are subject to change without notice. Any such change shall be evidenced by the publication of an updated version of this document by Wolfspeed. No communication from any employee or agent of Wolfspeed or any third party shall effect an amendment or modification of this document. No responsibility is assumed by Wolfspeed for any infringement of patents or other rights of third parties which may result from use of the information contained herein. No license is granted by implication or otherwise under any patent or patent rights of Wolfspeed.

The information contained in this document (excluding examples, as well as figures or values that are labeled as “typical”) constitutes Wolfspeed’s sole published specifications for the subject product. “Typical” parameters are the average values expected by Wolfspeed in large quantities and are provided for informational purposes only. Any examples provided herein have not been produced under conditions intended to replicate any specific end use. Product performance can and does vary due to a number of factors.

This product has not been designed or tested for use in, and is not intended for use in, any application in which failure of the product would reasonably be expected to cause death, personal injury, or property damage. For purposes of (but without limiting) the foregoing, this product is not designed, intended, or authorized for use as a critical component in equipment implanted into the human body, life-support machines, cardiac defibrillators, and similar emergency medical equipment; air traffic control systems; or equipment used in the planning, construction, maintenance, or operation of nuclear facilities. Notwithstanding any application-specific information, guidance, assistance, or support that Wolfspeed may provide, the buyer of this product is solely responsible for determining the suitability of this product for the buyer’s purposes, including without limitation (1) selecting the appropriate Wolfspeed products for the buyer’s application, (2) designing, validating, and testing the buyer’s application, and (3) ensuring the buyer’s application meets applicable standards and any other legal, regulatory, and safety-related requirements.

### RoHS Compliance

The levels of RoHS restricted materials in this product are below the maximum concentration values (also referred to as the threshold limits) permitted for such substances, or are used in an exempted application, in accordance with EU Directive 2011/65/EC (RoHS2), as implemented January 2, 2013. RoHS Declarations for this product can be obtained from your Wolfspeed representative or from the Product Documentation sections of [www.wolfspeed.com](http://www.wolfspeed.com).

### REACH Compliance

REACH substances of high concern (SVHCs) information is available for this product. Since the European Chemical Agency (ECHA) has published notice of their intent to frequently revise the SVHC listing for the foreseeable future, please contact your Wolfspeed representative to ensure you get the most up-to-date REACH SVHC Declaration. REACH banned substance information (REACH Article 67) is also available upon request.

### Contact info:

4600 Silicon Drive  
Durham, NC 27703 USA  
Tel: +1.919.313.5300  
[www.wolfspeed.com/power](http://www.wolfspeed.com/power)

© 2025 Wolfspeed, Inc. All rights reserved. Wolfspeed®, the Wolfspeed logo, and the Wolfstreak logo are registered trademarks and the Wolfspeed logo is a trademark of Wolfspeed, Inc.  
PATENT: <https://www.wolfspeed.com/legal/patents>

The information in this document is subject to change without notice.