

EDB004M06TM3, EDB004M06TM3L

Automotive 650 V, 4.4 mΩ, Silicon Carbide, Single Switch Power Module

V_{DS}	650 V
R_{DS(on)}	4.4 mΩ

Technical Features

- AQG 324 Qualified
- Very low On-State Resistance
- Baseplateless Module with High Performance Si₃N₄ Insulator
- Laser Weldable Power Terminals
- Sinterable and Solderable Backside (Silver Plated)
- Solderable Signal Pins (Silver Plated)
- Package with Extended Creepage
- Comparative Tracking Index (CTI) > 600 (Material Group I)
- Limited Extended Operation (T_{VJ(op)} = 200 °C for 100 h)

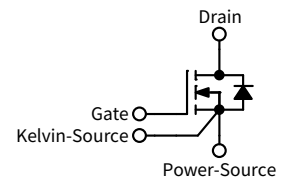
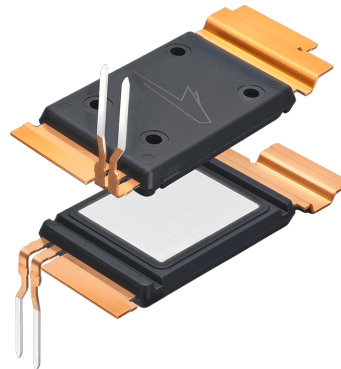

Typical Applications

- Automotive Traction Inverters

System Benefits

- Ultra-Low Loss
- High Performance in a small Footprint
- Design Flexibility
- Enables high Reliability Interconnects

Maximum Parameters (Verified by Design)

Parameter	Symbol	Min.	Typ.	Max.	Unit	Conditions	Note
Drain-Source Voltage	V _{DS}			650	V		
Gate-Source Voltage, Maximum Value	V _{GS(max)}	-8		+19		Transient	Note 1
Gate-Source Voltage, Recommended	V _{GS(op)}		-4/+15			Static	Fig. 27
DC Continuous Drain Current	I _D		330		A	V _{GS} = 15 V, T _C = 100 °C, T _{VJ} = 175 °C	Note 2
Virtual Junction Temperature	T _{VJ(op)}	-40		175	°C	Continuous operation	
				200		100 hours over lifetime	
Sinter Temperature	T _L		230				
Sinter Pressure	P _S		14		Mpa		

Note (1): Recommended turn-on gate voltage is 15 V with ±5 % regulation tolerance

Note (2): Current limit calculated by $I_{D(max)} = \sqrt{(P_D/R_{DS(typ)}(T_{VJ(max)}))}$ where $P_D = (T_{VJ} - T_C)/R_{th(JC,typ)}$



MOSFET Characteristics (T_{VJ} = 25 °C Unless Otherwise Specified)

Parameter	Symbol	Min.	Typ.	Max.	Unit	Conditions	Note
Drain-Source Breakdown Voltage	V _{(BR)DSS}	650				V _{GS} = 0 V, T _{VJ} = -40 °C	
Gate Threshold Voltage	V _{GS(th)}	1.8	2.5	3.6	V	V _{DS} = V _{GS} , I _D = 45 mA	Fig. 10
			2.0			V _{DS} = V _{GS} , I _D = 45 mA, T _{VJ} = 175 °C	
Zero Gate Voltage Drain Current	I _{DSS}		3	150	μA	V _{GS} = 0 V, V _{DS} = 650 V	
Gate-Source Leakage Current	I _{GSS}		30	750	nA	V _{GS} = 15 V, V _{DS} = 0 V	
Drain-Source On-State Resistance (Devices Only)	R _{DS(on)}		4.4	5.5	mΩ	V _{GS} = 15 V, I _D = 240 A	Note 3 Figs. 2, 3
			6.1	7.8		V _{GS} = 15 V, I _D = 240 A, T _{VJ} = 175 °C	
			6.8			V _{GS} = 15 V, I _D = 240 A, T _{VJ} = 200 °C	
Transconductance	g _{fs}		234		S	V _{DS} = 20 V, I _D = 240 A	Fig. 4
			208			V _{DS} = 20 V, I _D = 240 A, T _{VJ} = 175 °C	
Turn-On Switching Energy	E _{ON}		4.4		mJ	T _{VJ} = 25 °C	Figs. 11, 12, 13, 24, 25 V _{DS} = 400 V, I _D = 250 A, V _{GS} = -4 V/15 V, R _{G(ON)} = 2 Ω, R _{G(OFF)} = 1 Ω, L _G = 18.3 nH
			4.2			T _{VJ} = 175 °C	
Turn-Off Switching Energy	E _{OFF}		4.2			T _{VJ} = 200 °C	
			2.9			T _{VJ} = 25 °C	
			3.3			T _{VJ} = 175 °C	
			3.3			T _{VJ} = 200 °C	
Internal Gate Resistance	R _{G(int)}		2.7		Ω	f = 100 kHz, V _{AC} = 250 mV	
Input Capacitance	C _{iss}		16.4		nF	V _{GS} = 0 V, V _{DS} = 400 V, V _{AC} = 250 mV, f = 100 kHz	Fig. 9
Output Capacitance	C _{oss}		0.91				
Reverse Transfer Capacitance	C _{rss}		92				
Gate to Source Charge	Q _{GS}		180		nC	V _{DS} = 400 V, V _{GS} = -4 V/15 V, I _D = 240 A, per IEC60747-8-4	
Gate to Drain Charge	Q _{GD}		174				
Total Gate Charge	Q _G		596				
Thermal Resistance, Junction to Case	R _{th(JC)}		0.11		K/W		Fig. 16

Note (3): Total effective resistance = MOSFET R_{DS(on)} + package resistance



Diode Characteristics ($T_{VJ} = 25\text{ °C}$ Unless Otherwise Specified)

Parameter	Symbol	Min.	Typ.	Max.	Unit	Conditions	Note
Body Diode Forward Voltage (Devices Only)	V_{SD}		6.2		V	$V_{GS} = -4\text{ V}, I_{SD} = 240\text{ A}$	Fig. 7
			5.7			$V_{GS} = -4\text{ V}, I_{SD} = 240\text{ A}, T_{VJ} = 175\text{ °C}$	
Reverse Recovery Time	t_{RR}		27		ns	$V_{GS} = -4\text{ V}, I_{SD} = 250\text{ A}, V_R = 400\text{ V}, di/dt = 5.9\text{ A/ns}, T_{VJ} = 175\text{ °C}$	Fig. 26
Reverse Recovery Charge	Q_{RR}		1.2		μC		
Peak Reverse Recovery Current	I_{RRM}		75		A		
Reverse Recovery Energy	E_{RR}		0.1		mJ	$T_{VJ} = 25\text{ °C}$	Figs. 11, 12, 13, 14, 26 $V_{DS} = 400\text{ V}, I_D = 250\text{ A}, V_{GS} = -4\text{ V}/15\text{ V}, R_{G(ON)} = 2\text{ }\Omega, L_G = 18.3\text{ nH}$
			0.1			$T_{VJ} = 175\text{ °C}$	
			0.2			$T_{VJ} = 200\text{ °C}$	

Module Physical Characteristics

Parameter	Symbol	Min.	Typ.	Max.	Unit	Conditions	Note	
Package Resistance	R_{pkg}		0.15		m Ω	$T_C = 25\text{ °C}$	Drain to power-source	Note 3
			0.25			$T_C = 175\text{ °C}$		
Stray Inductance	L_{stray}		6.2		nH	Drain to power-source, $f = 10\text{ MHz}$		
Storage Temperature	T_{stg}	-40		125	$^{\circ}\text{C}$			
Weight	W		8.6		g			
Case Isolation Voltage	V_{isol}	4.3			kV	DC, $t = 1\text{ s}$		
Comparative Tracking Index	CTI	600						
Creepage Distance		6.3			mm	Terminal to thermal pad		

Note (3): Total effective resistance = MOSFET $R_{DS(on)}$ + package resistance



Typical Performance

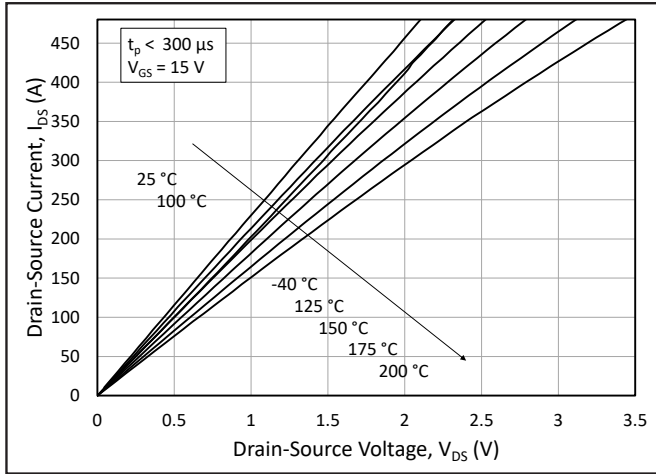

Figure 1. Output Characteristics for Various Junction Temperatures

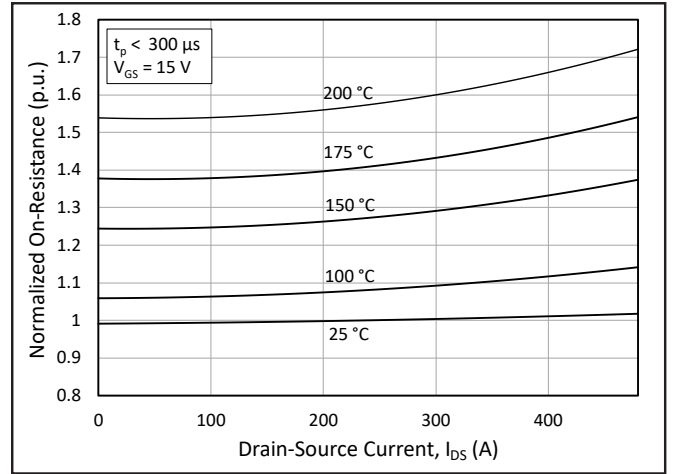

Figure 2. Normalized On-State Resistance vs. Drain Current for Various Junction Temperatures

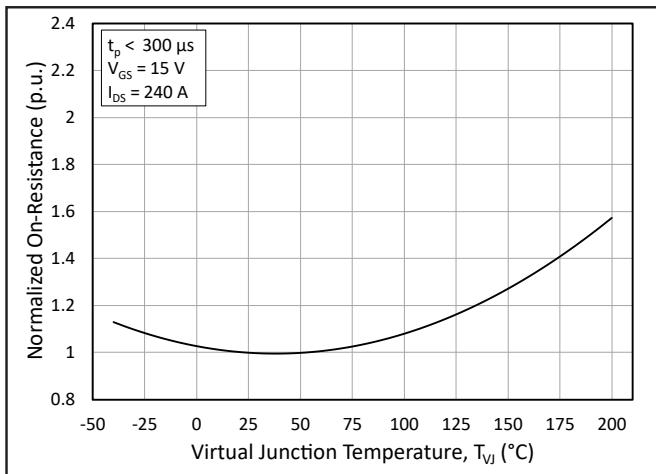

Figure 3. Normalized On-State Resistance vs. Junction Temperature

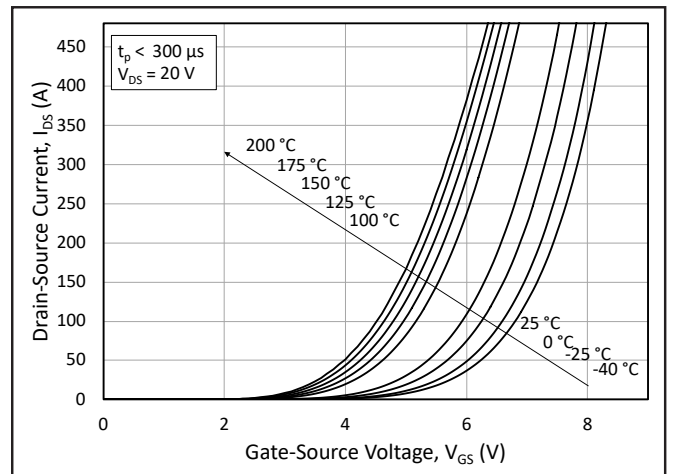

Figure 4. Transfer Characteristic for Various Junction Temperatures

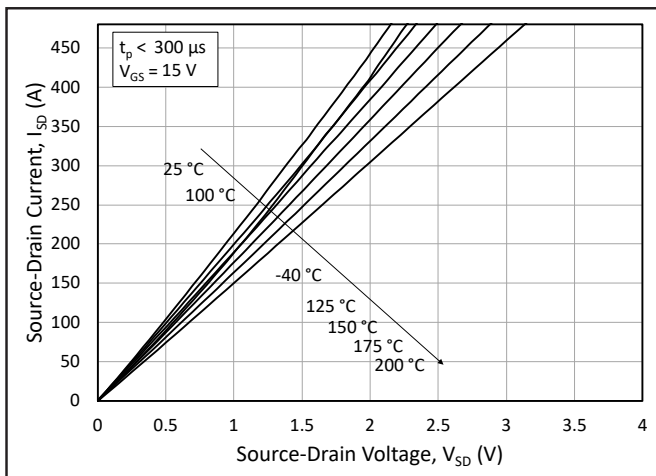

Figure 5. 3rd Quadrant Characteristic vs. Junction Temperatures at $V_{GS} = 15\text{ V}$

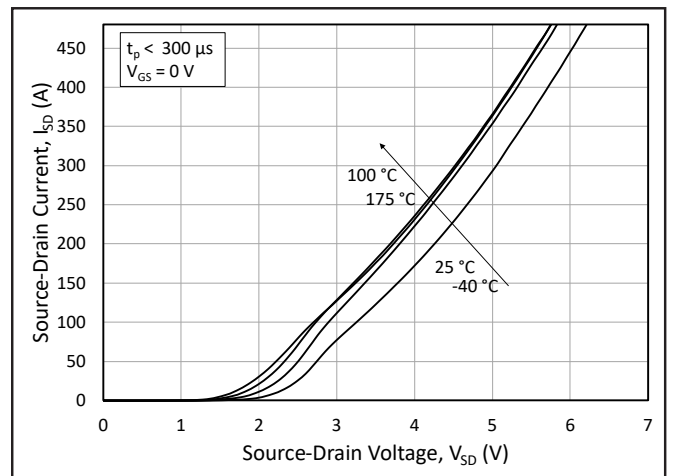

Figure 6. 3rd Quadrant Characteristic vs. Junction Temperatures at $V_{GS} = 0\text{ V}$ (Body Diode)

Typical Performance

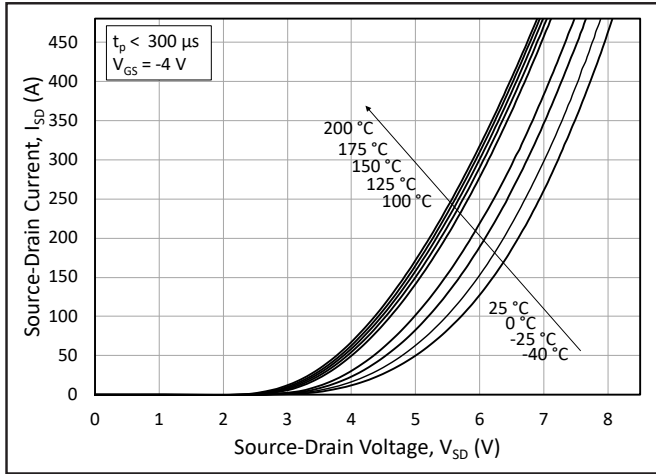

Figure 7. 3rd Quadrant Characteristic vs. Junction Temperatures at $V_{GS} = -4$ V (Body Diode)

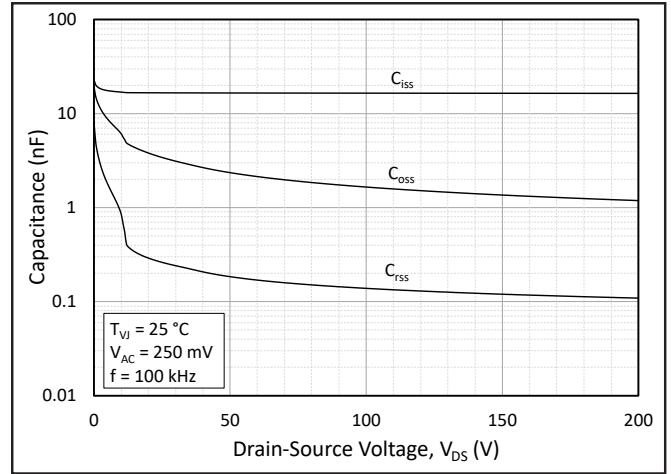

Figure 8. Typical Capacitances vs. Drain to Source Voltage (0 - 200 V)

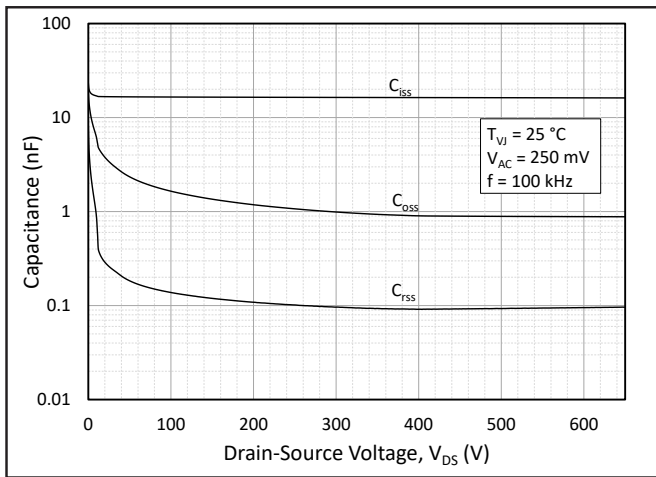

Figure 9. Typical Capacitances vs. Drain to Source Voltage (0 - 650V)

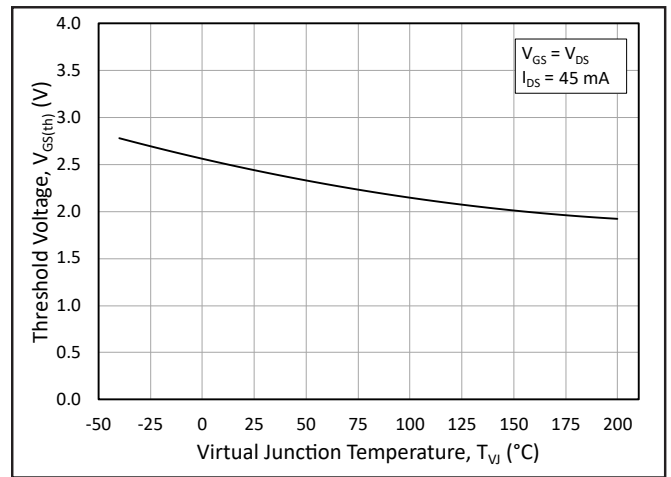

Figure 10. Threshold Voltage vs. Junction Temperature

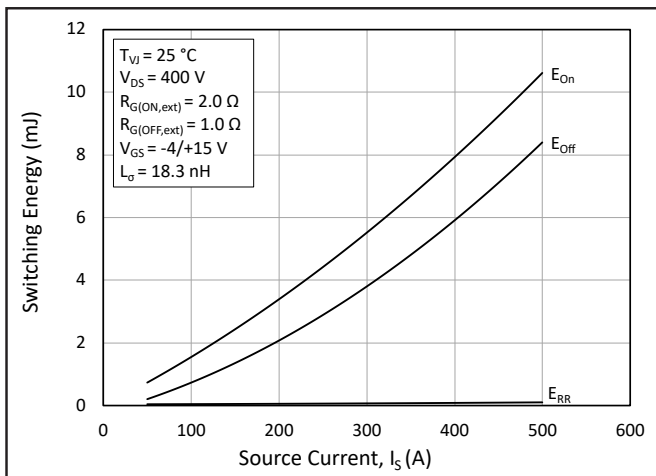

Figure 11. Switching Energy vs. Drain Current ($T_{Vj} = 25$ °C)

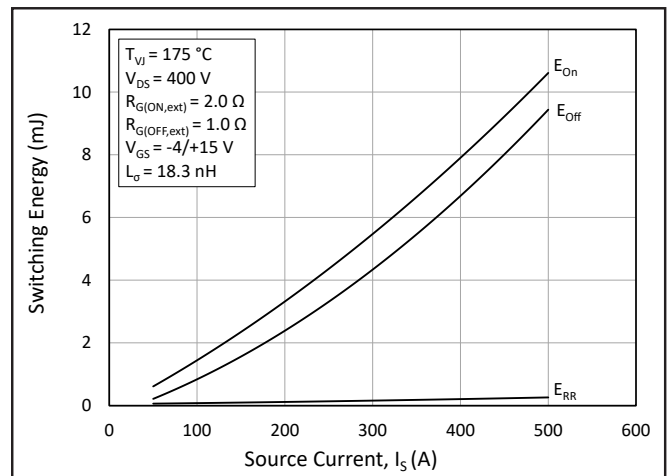

Figure 12. Switching Energy vs. Drain Current ($T_{Vj} = 175$ °C)



Typical Performance

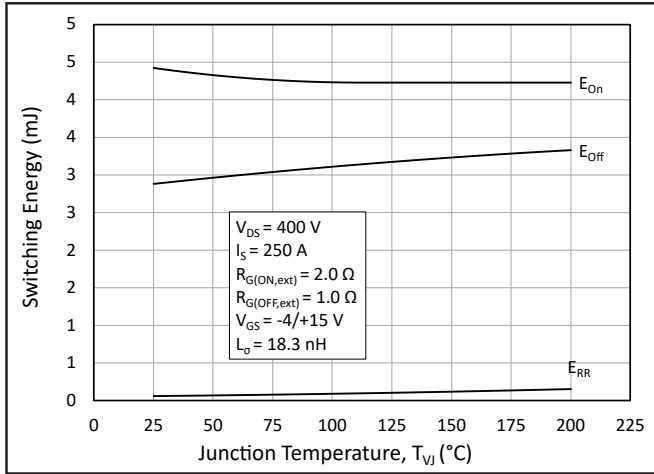

Figure 13. Switching Energy vs. Junction Temperature

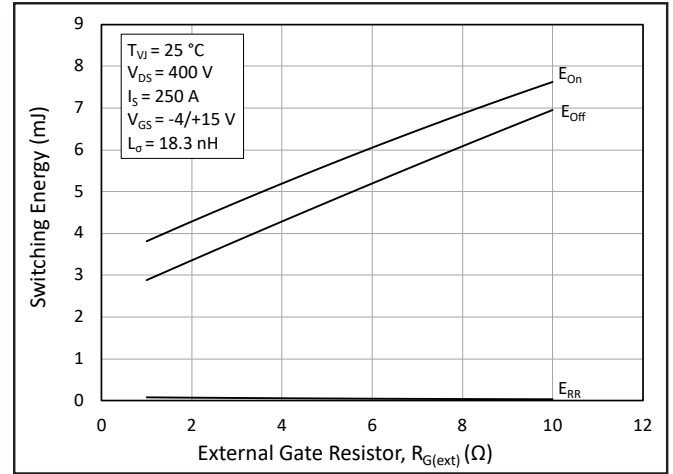

Figure 14. Switching Energy vs. External Gate Resistance

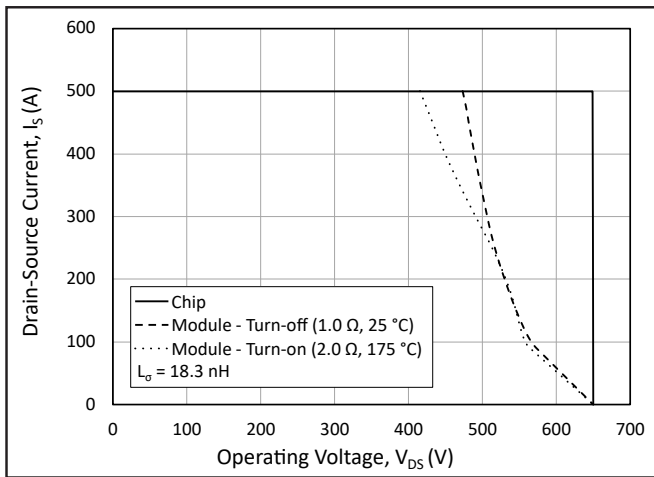

Figure 15. Switching Safe Operating Area

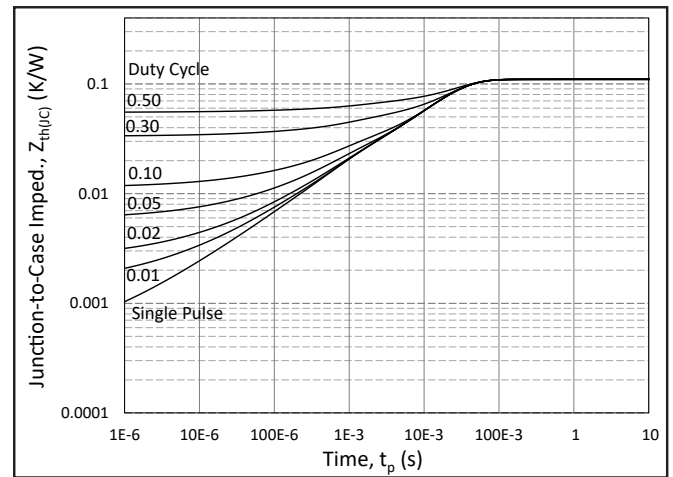

Figure 16. Junction to Case Transient Thermal Impedance

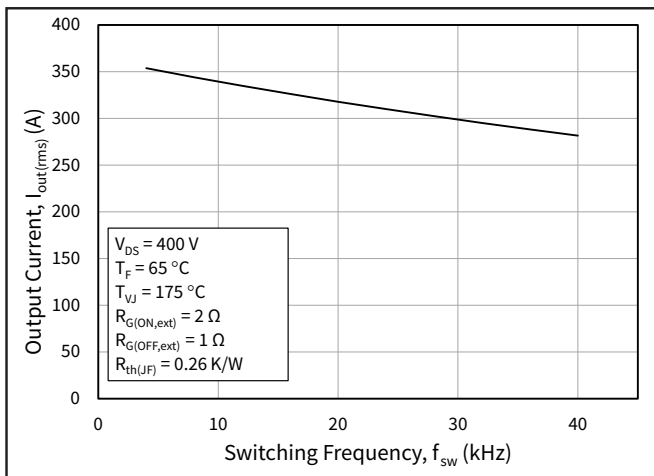

Figure 17. Typical Output Current Capability vs. Switching Frequency (Inverter Application)



Timing Characteristics

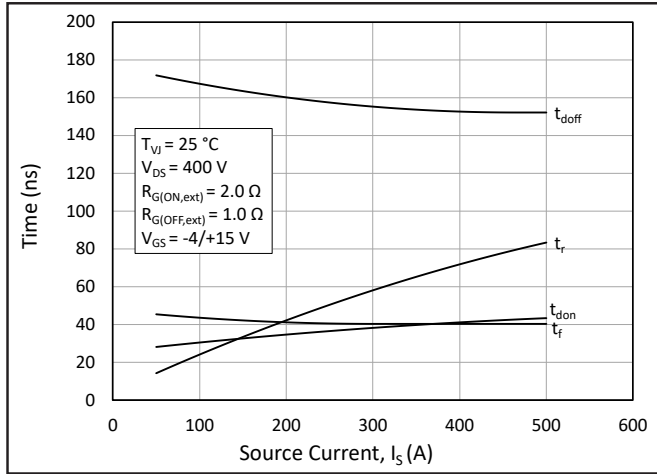

Figure 18. Timing vs. Source Current

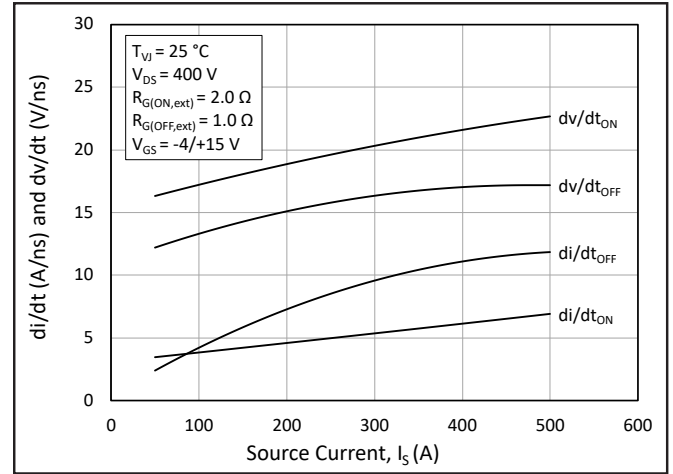

Figure 19. dv/dt and di/dt vs. Source Current

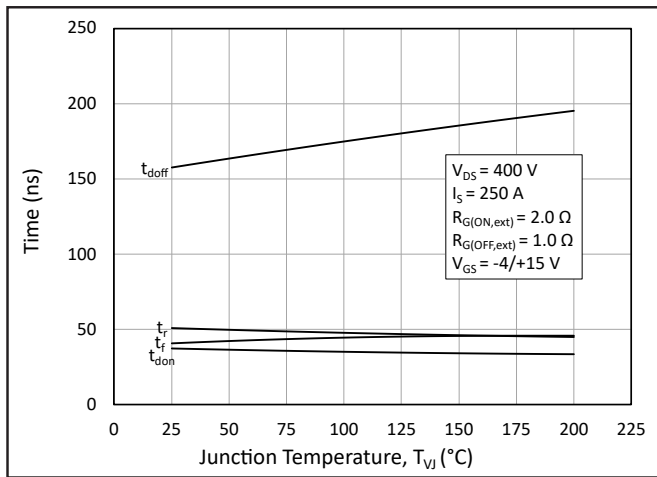

Figure 20. Timing vs. Junction Temperature

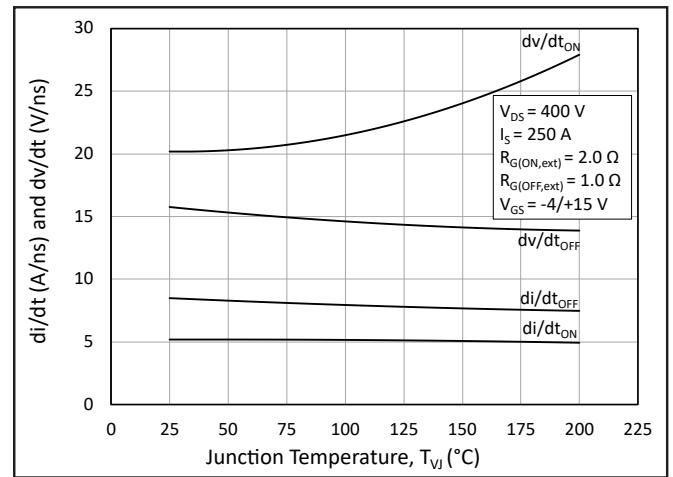

Figure 21. dv/dt and di/dt vs. Junction Temperature

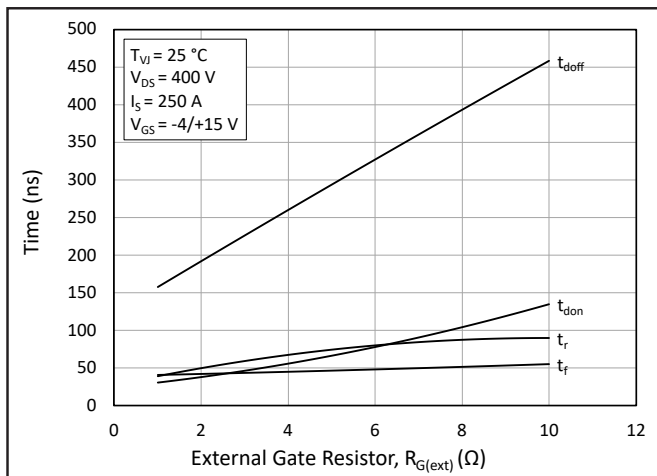

Figure 22. Timing vs. External Gate Resistance

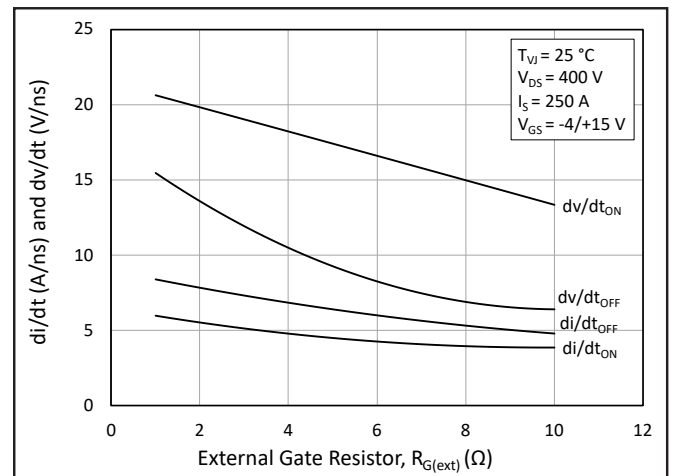

Figure 23. dv/dt and di/dt vs. External Gate Resistance

Definitions

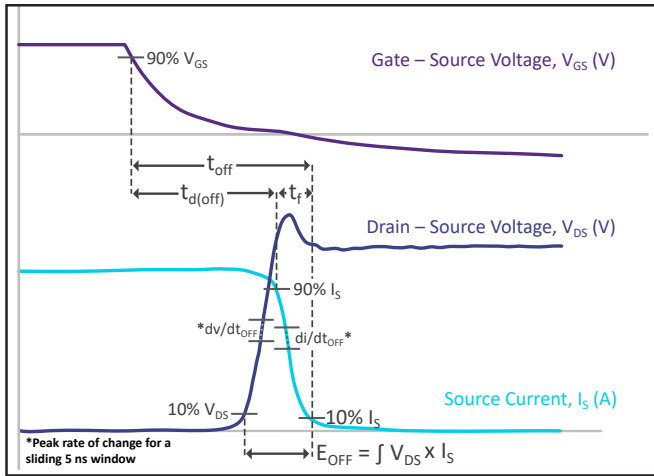

Figure 24. Turn-Off Transient Definitions

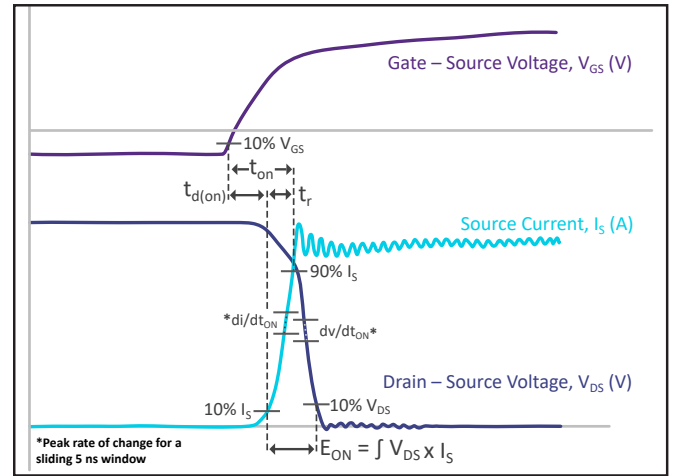

Figure 25. Turn-On Transient Definitions

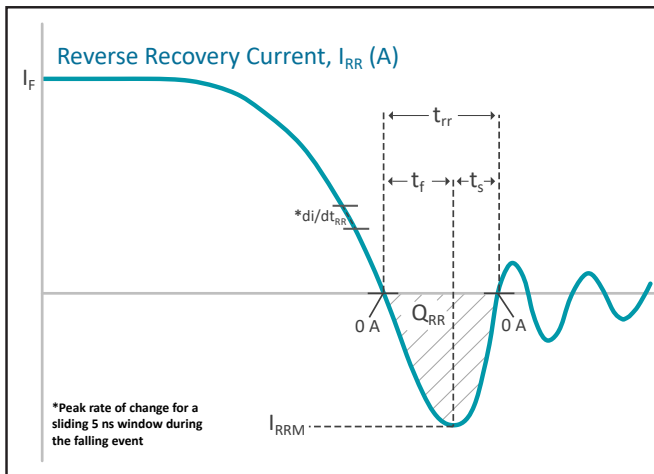

Figure 26. Reverse Recovery Definitions

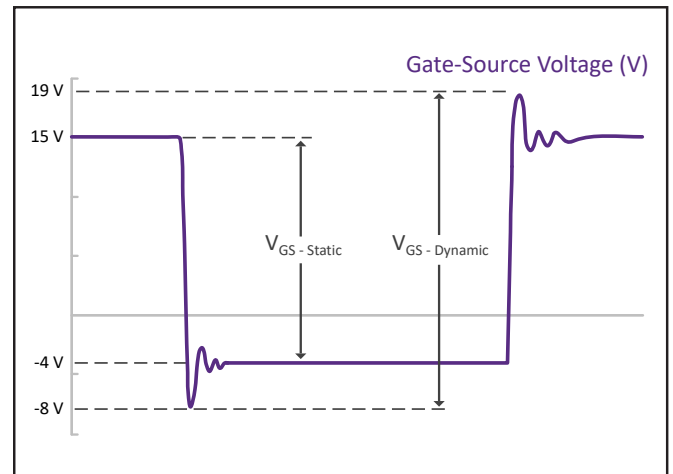
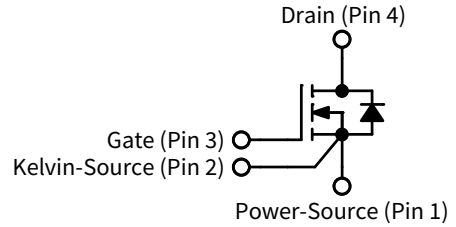
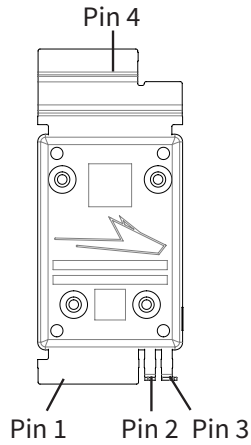

Figure 27. V_{GS} Transient Definitions

Schematic and Pin Out



Package Dimensions (mm)

DIMENSION TABLE	
SYM.	DIMENSION/TOLERANCE
A1	18.8±0.20
A2	13±0.20
A3	43.65±0.30
B1	28.1±0.20
B2	18.9±0.30
A4	17.7±0.40
A5	14.4±0.40
A6	2× 0.9±0.10
A7	2× [40°]
A8	[9.1] - Short pin version 9.6 - Long pin version
A9	18.5±0.50 - Short pin version 19.0±0.50 - Long pin version
A10	2× R0.1±0.10
B3	4.1±0.10
A11	4±0.30
A12	2.3±0.30
A13	[0.381]
A14	36.37±0.30
A15	39.37±0.30
A16	0.69±0.65
B4	2.3±0.30
B5	[14.7]
B6	[18.5]
A17	9.5 MAX
A18	[0.8]
A19	[0.8]
A20	[0.8]
A21	13.1±0.20
A22	2.3 MAX

NOTE	
A	Ag Plating, Signal Pins
B	Ag Plating, Thermal Pad

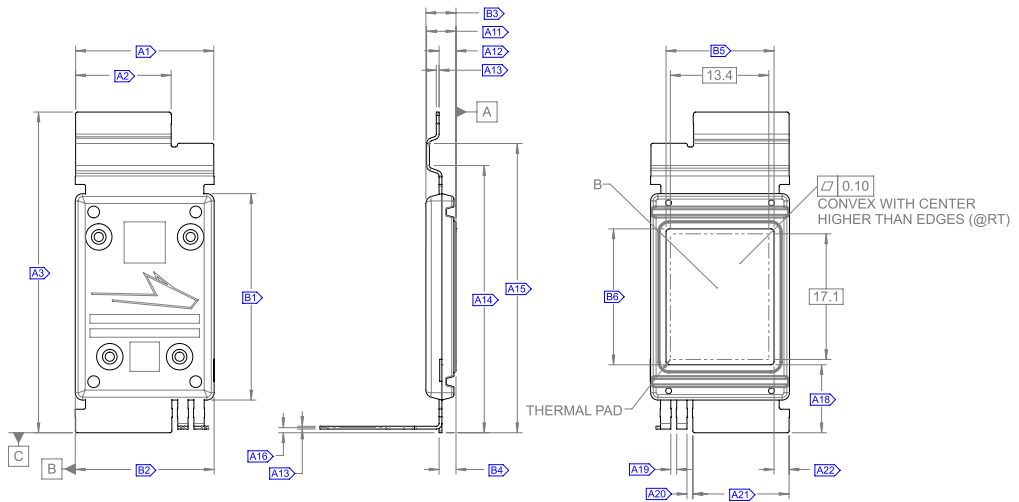

UNLESS OTHERWISE SPECIFIED:
• ALL SURFACES: [0.40] A | B | C



Product Ordering Code

Part Number	Description
EDB004M06TM3	Short gate and Kelvin-source pin length
EDB004M06TM3L	Long gate and Kelvin-source pin length

Revision History

Revision History	Date	Brief Summary
Rev. 1	October 2025	Initial release
Rev. 2	December 2025	Updated drawing; added missing line in Fig.1

Supporting Links & Tools

Evaluation Tools & Support

- [PLECS Circuit Model](#)
- 3D CAD Model
- FEA Thermal Model - Available Upon Request
- KIT-CRD-CIL-12N-TMA: Dynamic Performance Evaluation Kit for TM Power Modules

Application Notes

- [PRD-04814: Design Options for Wolfspeed® Silicon Carbide MOSFET Gate Bias Power Supplies](#)
- [PRD-06379: Environmental Considerations for Power Electronics Systems](#)
- [PRD-08333: Wolfspeed Module CIL Evaluation Kits User Guide](#)
- [PRD-08376: Thermal Characterization Methods and Applications](#)
- [PRD-08710: Measuring Stray Inductance in Power Electronics Systems](#)
- [PRD-08911: Considerations for Current Balancing in Paralleled SiC Power Modules](#)



Notes & Disclaimers

WOLFSPEED PROVIDES TECHNICAL AND RELIABILITY DATA, DESIGN RESOURCES, APPLICATION OR OTHER DESIGN ADVICE, WEB TOOLS, AND OTHER RESOURCES “AS IS” AND WITH ALL FAULTS, AND DISCLAIMS ALL WARRANTIES, EXPRESS AND IMPLIED, WITH RESPECT THERETO, INCLUDING WITHOUT LIMITATION ANY IMPLIED WARRANTIES OF MERCHANTABILITY, SUITABILITY, FITNESS FOR A PARTICULAR PURPOSE, OR NON-INFRINGEMENT OF THIRD-PARTY INTELLECTUAL PROPERTY RIGHTS.

This document and the information contained herein are subject to change without notice. Any such change shall be evidenced by the publication of an updated version of this document by Wolfspeed. No communication from any employee or agent of Wolfspeed or any third party shall effect an amendment or modification of this document. No responsibility is assumed by Wolfspeed for any infringement of patents or other rights of third parties which may result from use of the information contained herein. No license is granted by implication or otherwise under any patent or patent rights of Wolfspeed.

The information contained in this document (excluding examples, as well as figures or values that are labeled as “typical”) constitutes Wolfspeed’s sole published specifications for the subject product. “Typical” parameters are the average values expected by Wolfspeed in large quantities and are provided for informational purposes only. Any examples provided herein have not been produced under conditions intended to replicate any specific end use. Product performance can and does vary due to a number of factors.

This product has not been designed or tested for use in, and is not intended for use in, any application in which failure of the product would reasonably be expected to cause death, personal injury, or property damage. For purposes of (but without limiting) the foregoing, this product is not designed, intended, or authorized for use as a critical component in equipment implanted into the human body, life-support machines, cardiac defibrillators, and similar emergency medical equipment; air traffic control systems; or equipment used in the planning, construction, maintenance, or operation of nuclear facilities. Notwithstanding any application-specific information, guidance, assistance, or support that Wolfspeed may provide, the buyer of this product is solely responsible for determining the suitability of this product for the buyer’s purposes, including without limitation (1) selecting the appropriate Wolfspeed products for the buyer’s application, (2) designing, validating, and testing the buyer’s application, and (3) ensuring the buyer’s application meets applicable standards and any other legal, regulatory, and safety-related requirements.

RoHS Compliance

The levels of RoHS restricted materials in this product are below the maximum concentration values (also referred to as the threshold limits) permitted for such substances, or are used in an exempted application, in accordance with EU Directive 2011/65/EC (RoHS2), as implemented January 2, 2013. RoHS Declarations for this product can be obtained from your Wolfspeed representative or from the Product Documentation sections of www.wolfspeed.com.

REACH Compliance

REACH substances of high concern (SVHCs) information is available for this product. Since the European Chemical Agency (ECHA) has published notice of their intent to frequently revise the SVHC listing for the foreseeable future, please contact your Wolfspeed representative to ensure you get the most up-to-date REACH SVHC Declaration. REACH banned substance information (REACH Article 67) is also available upon request.

Contact info:

4600 Silicon Drive
Durham, NC 27703 USA
Tel: +1.919.313.5300
www.wolfspeed.com/power