

CHB011M12GM4, CHB011M12GM4T

1200 V, 11 mΩ, Silicon Carbide, T-Type Module

| | |
|--------------|---------------|
| V_{DS} | 1200 V |
| $R_{DS(on)}$ | 11 mΩ |

Technical Features

- Ultra-Low Loss
- High Frequency Operation
- Zero Turn-Off Tail Current from MOSFET
- Normally-Off, Fail-Safe Device Operation
- Optional Pre-Applied Thermal Interface Material
- Features Gen4 Technology with Soft Body Diode

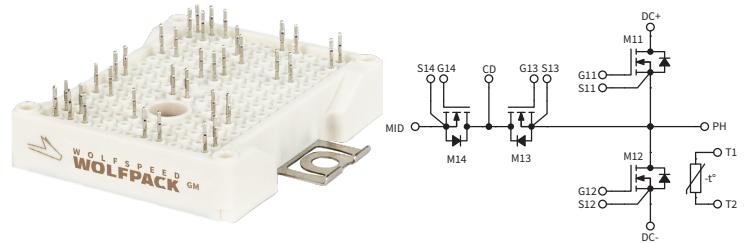

Typical Applications

- EV Chargers
- High-Efficiency Converters / Inverters
- Renewable Energy
- Smart-Grid / Grid-Tied Distributed Generation

System Benefits

- Enables Compact, Lightweight Systems
- Increased System Efficiency, due to Low Switching & Conduction Losses of SiC
- Reduced Thermal Requirements and System Cost

Key Parameters

| Parameter | Symbol | Min. | Typ. | Max. | Unit | Test Conditions | Note |
|---|---------------|------|-------|------|--------------------|--|----------------------|
| Drain-Source Voltage | V_{DS} | | | 1200 | V | $T_{HS} = 25\text{ }^{\circ}\text{C}$ | |
| Maximum Gate-Source Voltage | $V_{GS(max)}$ | -8 | | +19 | | Transient | Fig. 32 |
| Operational Gate-Source Voltage | $V_{GS(op)}$ | | -4/15 | | | Static | Note 1 |
| DC Continuous Drain Current ($T_{VJ} \leq 150\text{ }^{\circ}\text{C}$) | I_D | | | 100 | A | $V_{GS} = 15\text{ V}, T_{HS} = 50\text{ }^{\circ}\text{C}, T_{VJ} \leq 150\text{ }^{\circ}\text{C}$ | Notes 2,3 Fig. 20 |
| DC Continuous Drain Current ($T_{VJ} \leq 175\text{ }^{\circ}\text{C}$) | | | | 100 | | $V_{GS} = 15\text{ V}, T_{HS} = 50\text{ }^{\circ}\text{C}, T_{VJ} \leq 175\text{ }^{\circ}\text{C}$ | |
| Pulsed Drain Current | I_{DM} | | | 200 | | t_{Pmax} limited by T_{VJmax} $V_{GS} = 15\text{ V}, T_{HS} = 50\text{ }^{\circ}\text{C}$ | |
| Power Dissipation | P_D | | 265 | | W | $T_{HS} = 50\text{ }^{\circ}\text{C}, T_{VJ} \leq 175\text{ }^{\circ}\text{C}$ | Note 4 Fig. 20 |
| Virtual Junction Temperature | $T_{VJ(op)}$ | -40 | | 150 | $^{\circ}\text{C}$ | Operation | |
| | | -40 | | 175 | $^{\circ}\text{C}$ | Intermittent with Reduced Life | |

Note (1): Recommended turn-on gate voltage is 15 V with $\pm 5\%$ regulation tolerance

Note (2): Current limit at $T_{HS} = 50\text{ }^{\circ}\text{C}$ calculated by $I_{D(max)} = \sqrt{P_D / R_{DS(typ)}(T_{VJ(max)}, I_{D(max)})}$

Note (3): Verified by design

Note (4): $P_D = (T_{VJ} - T_{HS}) / R_{TH(JH,typ)}$

MOSFET Characteristics (Per Position) ($T_{VJ} = 25\text{ }^{\circ}\text{C}$ unless otherwise specified)

| Parameter | Symbol | Min. | Typ. | Max. | Unit | Test Conditions | Note |
|--|---------------|-----------|----------------------|------|-----------------------------|---|--------------------|
| Drain-Source Breakdown Voltage | $V_{(BR)DSS}$ | 1200 | | | | $V_{GS} = 0\text{ V}, T_{VJ} = -40\text{ }^{\circ}\text{C}$ | |
| Gate Threshold Voltage | $V_{GS(th)}$ | 1.8 | 2.5 | 4.0 | V | $V_{DS} = V_{GS}, I_D = 28\text{ mA}$ | |
| | | | 2.0 | | | $V_{DS} = V_{GS}, I_D = 28\text{ mA}, T_{VJ} = 175\text{ }^{\circ}\text{C}$ | |
| Zero Gate Voltage Drain Current | I_{DSS} | | 3 | 300 | μA | $V_{GS} = 0\text{ V}, V_{DS} = 1200\text{ V}$ | |
| Gate-Source Leakage Current | I_{GSS} | | 60 | 1200 | nA | $V_{GS} = 19\text{ V}, V_{DS} = 0\text{ V}$ | |
| Drain-Source On-State Resistance (Devices Only) | $R_{DS(on)}$ | | 11.0 | 14.9 | m Ω | $V_{GS} = 15\text{ V}, I_D = 100\text{ A}$ | Fig. 2 Fig. 3 |
| | | | 17.6 | | | $V_{GS} = 15\text{ V}, I_D = 100\text{ A}, T_{VJ} = 150\text{ }^{\circ}\text{C}$ | |
| | | | 19.8 | | | $V_{GS} = 15\text{ V}, I_D = 100\text{ A}, T_{VJ} = 175\text{ }^{\circ}\text{C}$ | |
| Transconductance | g_{fs} | | 77 | | S | $V_{DS} = 20\text{ V}, I_D = 100\text{ A}$ | Fig. 4 |
| | | | 78 | | | $V_{DS} = 20\text{ V}, I_D = 100\text{ A}, T_{VJ} = 175\text{ }^{\circ}\text{C}$ | |
| Turn-On Switching Energy, $T_{VJ} = 25\text{ }^{\circ}\text{C}$ $T_{VJ} = 125\text{ }^{\circ}\text{C}$ $T_{VJ} = 175\text{ }^{\circ}\text{C}$ | E_{On} | | 0.29 0.26 0.25 | | mJ | $V_{DD} = 400\text{ V},$ $I_D = 100\text{ A},$ $V_{GS} = -4\text{ V}/15\text{ V},$ $R_{G(OFF)} = 0\text{ }\Omega, R_{G(ON)} = 0\text{ }\Omega,$ $L_{\sigma} = 25\text{ nH}$ | Fig. 11 Fig. 13 |
| Turn-Off Switching Energy, $T_{VJ} = 25\text{ }^{\circ}\text{C}$ $T_{VJ} = 125\text{ }^{\circ}\text{C}$ $T_{VJ} = 175\text{ }^{\circ}\text{C}$ | | E_{Off} | 0.13 0.11 0.12 | | | | |
| Internal Gate Resistance | $R_{G(int)}$ | | 1.4 | | Ω | $f = 100\text{ kHz}$ | |
| Input Capacitance | C_{iss} | | 10.1 | | nF | $V_{GS} = 0\text{ V}, V_{DS} = 800\text{ V},$ $V_{AC} = 25\text{ mV}, f = 100\text{ kHz}$ | Fig. 9 |
| Output Capacitance | C_{oss} | | 0.4 | | | | |
| Reverse Transfer Capacitance | C_{rss} | | 36 | | | | |
| Gate to Source Charge | Q_{GS} | | 180 | | nC | $V_{DS} = 800\text{ V}, V_{GS} = -4\text{ V}/15\text{ V},$ $I_D = 100\text{ A},$ Per IEC60747-8-4 pg 21 | |
| Gate to Drain Charge | Q_{GD} | | 96 | | | | |
| Total Gate Charge | Q_G | | 405 | | | | |
| FET Thermal Resistance, Junction to Heatsink | $R_{th JH}$ | | 0.472 | | $^{\circ}\text{C}/\text{W}$ | Measured with Pre-Applied TIM | Fig. 17 |

Diode Characteristics (Per Position) ($T_{VJ} = 25\text{ }^{\circ}\text{C}$ unless otherwise specified)

| Parameter | Symbol | Min. | Typ. | Max. | Unit | Test Conditions | Notes |
|--|-------------|------|----------------------|------|---------------|---|-------------------------|
| Body Diode Forward Voltage | V_{SD} | | 5.8 | | V | $V_{GS} = -4\text{ V}, I_{SD} = 100\text{ A}$ | Fig. 7 |
| | | | 5.4 | | | $V_{GS} = -4\text{ V}, I_{SD} = 100\text{ A}, T_{VJ} = 175\text{ }^{\circ}\text{C}$ | |
| DC Source-Drain Current (Body Diode) | $I_{SD BD}$ | | 58 | | A | $V_{GS} = -4\text{ V}, T_{HS} = 50\text{ }^{\circ}\text{C}, T_{VJ} \leq 175\text{ }^{\circ}\text{C}$ | Notes 2,3 Fig. 20 |
| Reverse Recovery Time | t_{RR} | | 27.0 | | ns | $V_{GS} = -4\text{ V}, I_{SD} = 100\text{ A}, V_R = 400\text{ V}$ $di/dt = 12.8\text{ A/ns}, T_{VJ} = 175\text{ }^{\circ}\text{C}$ | Fig. 31 |
| Reverse Recovery Charge | Q_{RR} | | 2.2 | | μC | | |
| Peak Reverse Recovery Current | I_{RRM} | | 149 | | A | | |
| Reverse Recovery Energy, $T_{VJ} = 25\text{ }^{\circ}\text{C}$ $T_{VJ} = 125\text{ }^{\circ}\text{C}$ $T_{VJ} = 175\text{ }^{\circ}\text{C}$ | E_{RR} | | 0.53 0.54 0.73 | | mJ | $V_{DD} = 400\text{ V}, I_D = 100\text{ A},$ $V_{GS} = -4\text{ V}/15\text{ V}, R_{G(ON)} = 0\text{ }\Omega,$ $L_{\sigma} = 25\text{ nH}$ | Fig. 14 |



Module Physical Characteristics

| Parameter | Symbol | Min. | Typ. | Max. | Unit | Test Conditions |
|-------------------------------|--------------|------|------|------|--------------------|--|
| Package Resistance, M11 | R_{pkg1} | | 0.57 | | mΩ | $T_{HS} = 125^{\circ}\text{C}$, Note 5 |
| Package Resistance, M12 | R_{pkg2} | | 0.76 | | | |
| Package Resistance, M13 & M14 | R_{pkg3} | | 0.81 | | | |
| Stray Inductance | L_{stray1} | | 17.5 | | nH | Between MID and DC+, $f = 10\text{ MHz}$ |
| | L_{stray2} | | 23.8 | | | Between MID and DC-, $f = 10\text{ MHz}$ |
| Case Temperature | T_c | -40 | | 125 | $^{\circ}\text{C}$ | |
| Mounting Torque | M_s | | 2.0 | 2.3 | N-m | M4 bolts |
| Weight | W | | 39 | | g | |
| Case Isolation Voltage | V_{isol} | 3 | | | kV | AC, 50 Hz, 1 minute |
| Comparative Tracking Index | CTI | 200 | | | | |
| Clearance Distance | | | 5.0 | | mm | Terminal to Terminal |
| | | | 10.0 | | | Terminal to Heatsink |
| Creepage Distance | | | 6.3 | | | Terminal to Terminal |
| | | | 11.5 | | | Terminal to Heatsink |

Note (5): Total Effective Resistance (Per Switch Position) = MOSFET $R_{DS(on)}$ + Switch Position Package Resistance

NTC Thermistor Characterization

| Parameter | Symbol | Min. | Typ. | Max. | Unit | Test Conditions |
|--|------------------|------|------|------|------|--------------------------------|
| Rated Resistance | R_{NTC} | | 5.0 | | kΩ | $T_{NTC} = 25^{\circ}\text{C}$ |
| Resistance Tolerance at 25 °C | $\Delta R/R$ | -5 | | 5 | % | |
| Beta Value ($T_2 = 50^{\circ}\text{C}$) | $\beta_{25/50}$ | | 3380 | | K | |
| Beta Value ($T_2 = 80^{\circ}\text{C}$) | $\beta_{25/80}$ | | 3468 | | K | |
| Beta Value ($T_2 = 100^{\circ}\text{C}$) | $\beta_{25/100}$ | | 3523 | | K | |
| Power Dissipation | P_{Max} | | | 10 | mW | $T_{NTC} = 25^{\circ}\text{C}$ |



Typical Performance

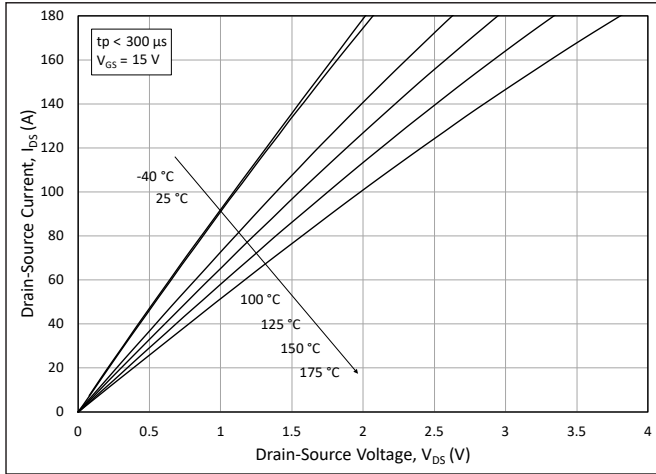

Figure 1. Output Characteristics for Various Junction Temperatures

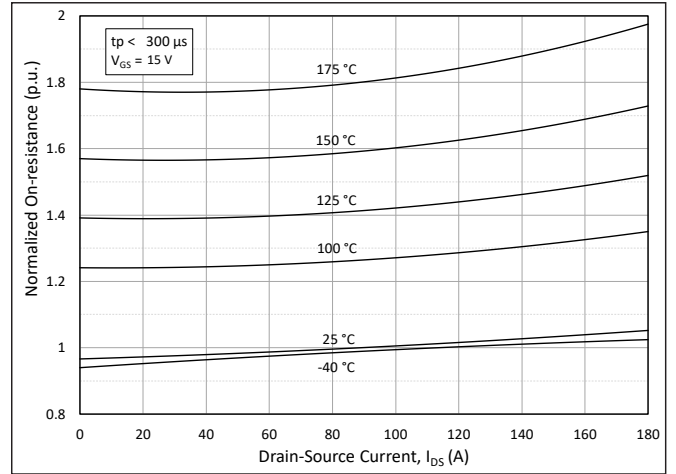

Figure 2. Normalized On-State Resistance vs. Drain Current for Various Junction Temperatures

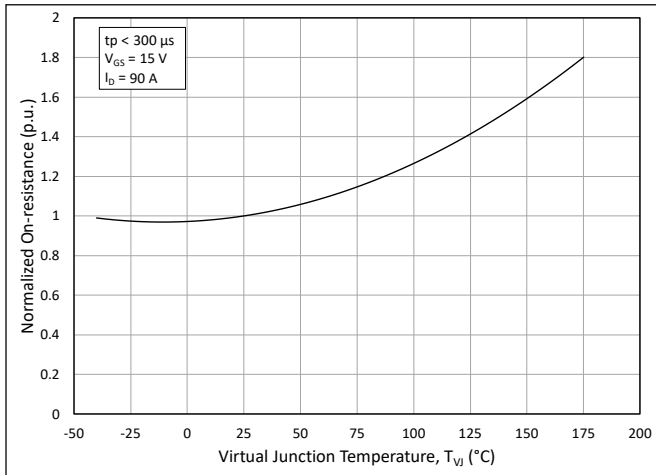

Figure 3. Normalized On-State Resistance vs. Junction Temperature

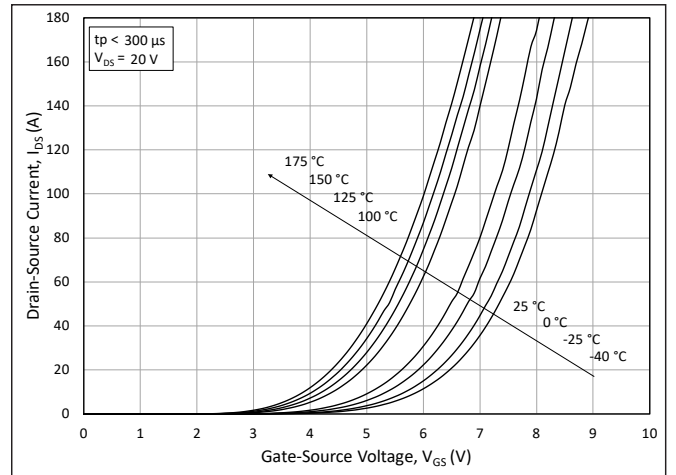

Figure 4. Transfer Characteristic for Various Junction Temperatures

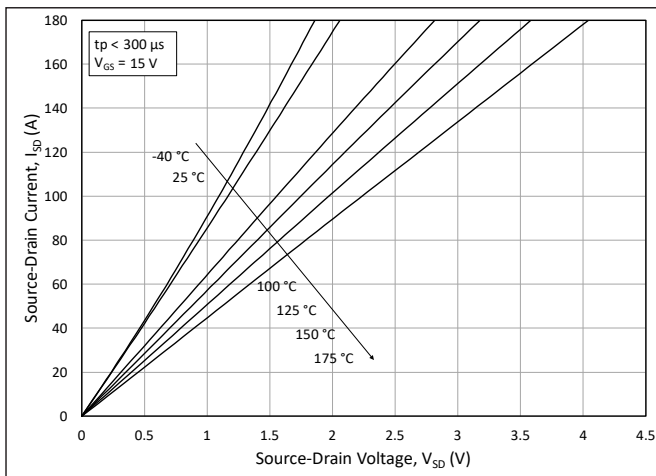

Figure 5. 3rd Quadrant Characteristic vs. Junction Temperatures at $V_{GS} = 15\text{ V}$

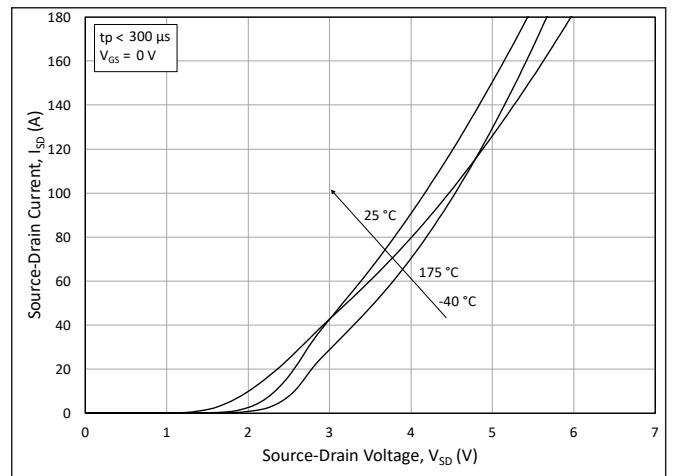

Figure 6. 3rd Quadrant Characteristic vs. Junction Temperatures at $V_{GS} = 0\text{ V}$ (Body Diode)



Typical Performance

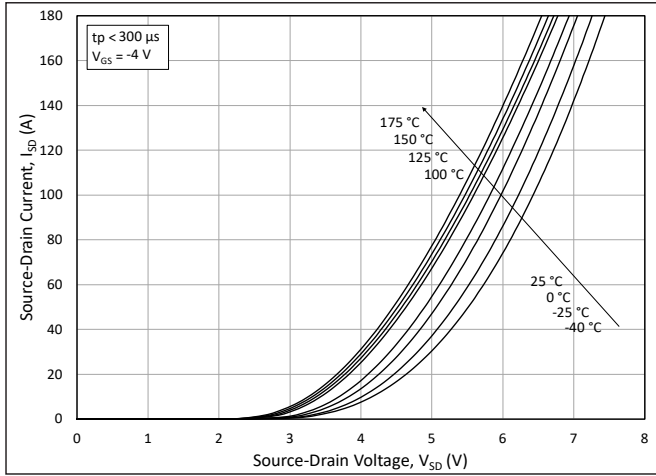

Figure 7. 3rd Quadrant Characteristic vs. Junction Temperatures at $V_{GS} = -4$ V (Body Diode)

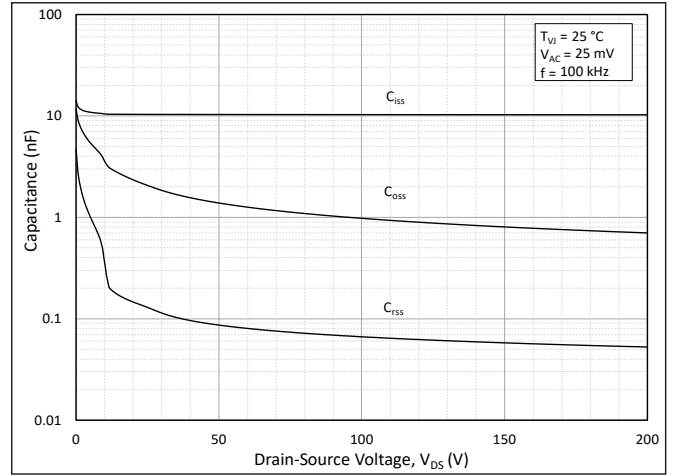

Figure 8. Typical Capacitances vs. Drain to Source Voltage (0 - 200V)

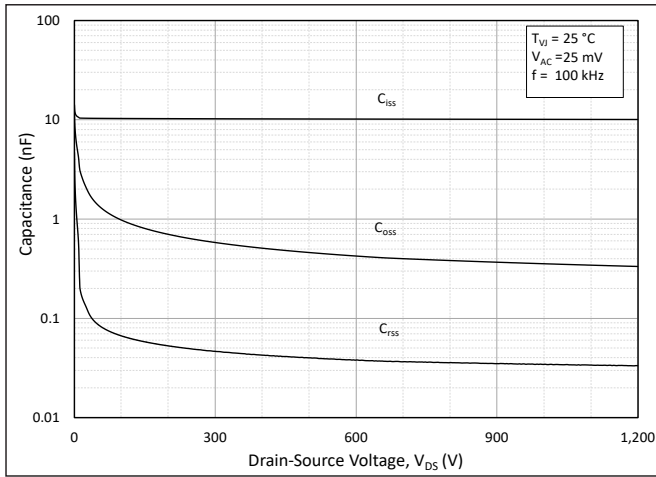

Figure 9. Typical Capacitances vs. Drain to Source Voltage (0 - 1200V)

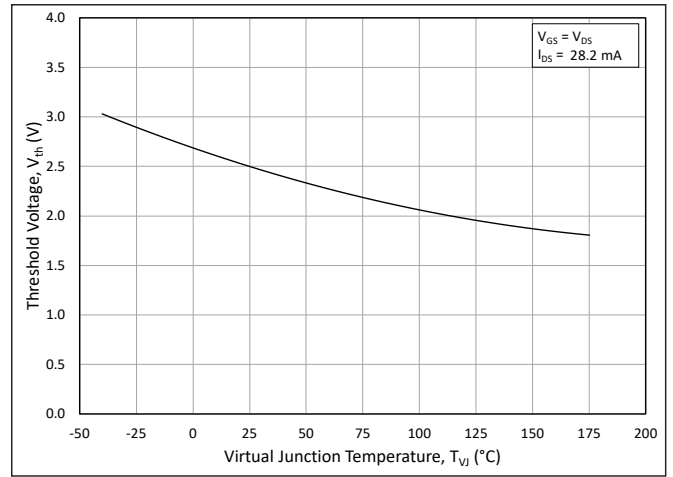

Figure 10. Threshold Voltage vs. Junction Temperature

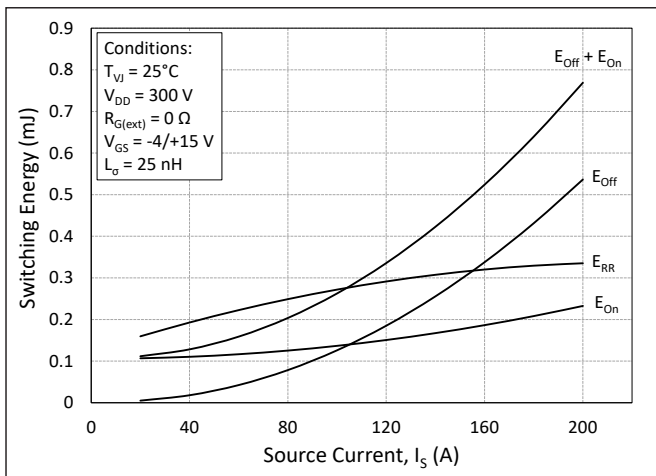

Figure 11. Switching Energy vs. Drain Current ($V_{DD} = 300$ V)

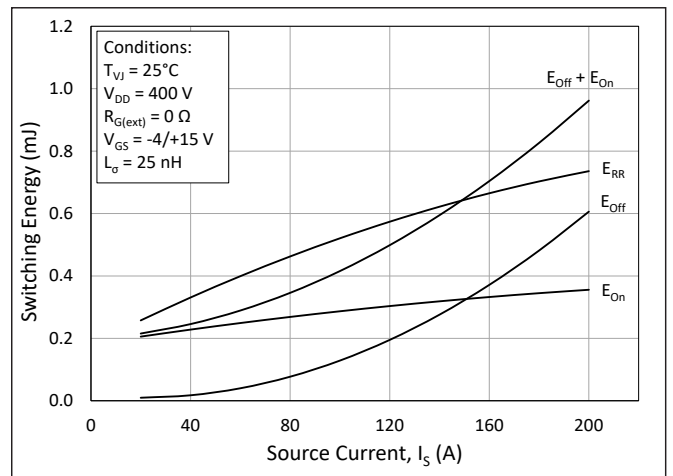

Figure 12. Switching Energy vs. Drain Current ($V_{DD} = 400$ V)



Typical Performance

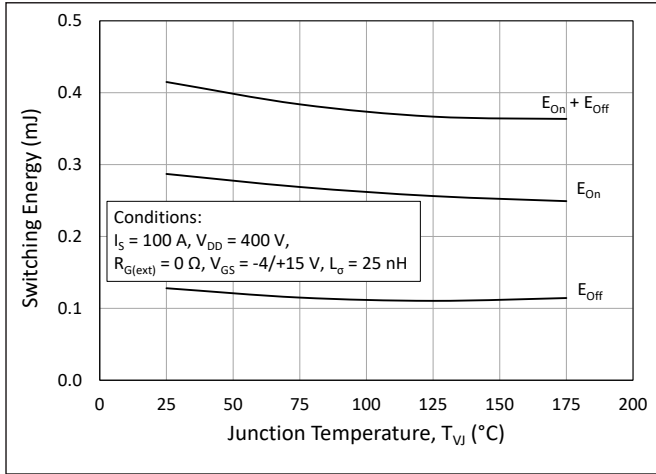

Figure 13. MOSFET Switching Energy vs. Junction Temperature

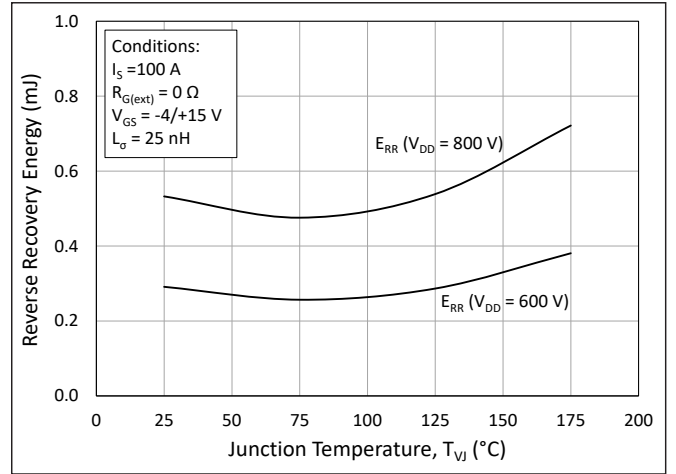

Figure 14. Reverse Recovery Energy vs. Junction Temperature

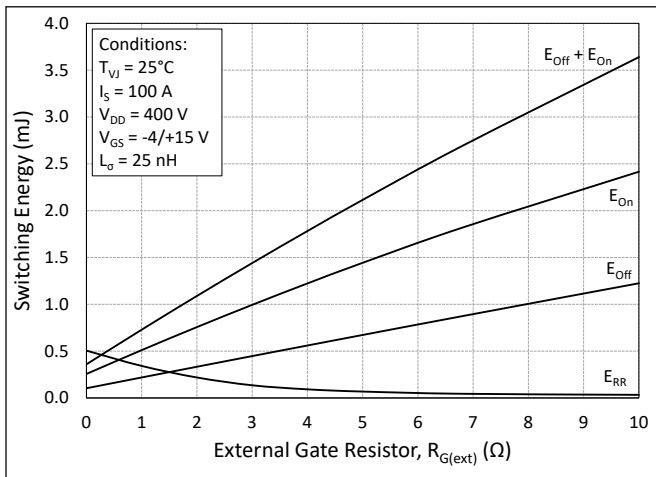

Figure 15. MOSFET Switching Energy vs. External Gate Resistance

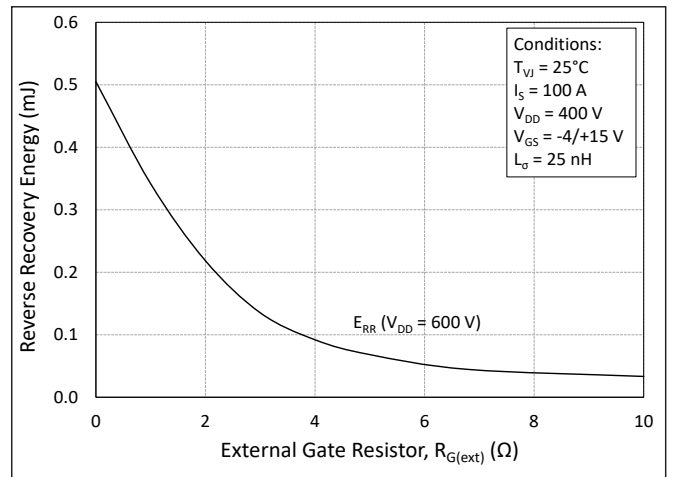

Figure 16. Reverse Recovery Energy vs. External Gate Resistance

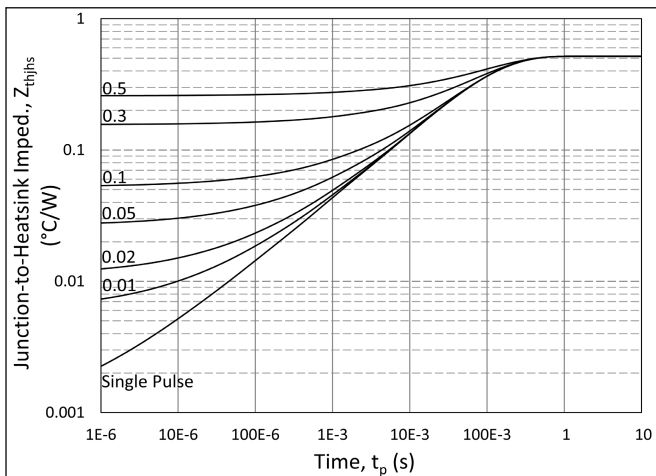

Figure 17. MOSFET Junction to Heatsink Transient Thermal Impedance, $Z_{th\ JHS}$ (°C/W)

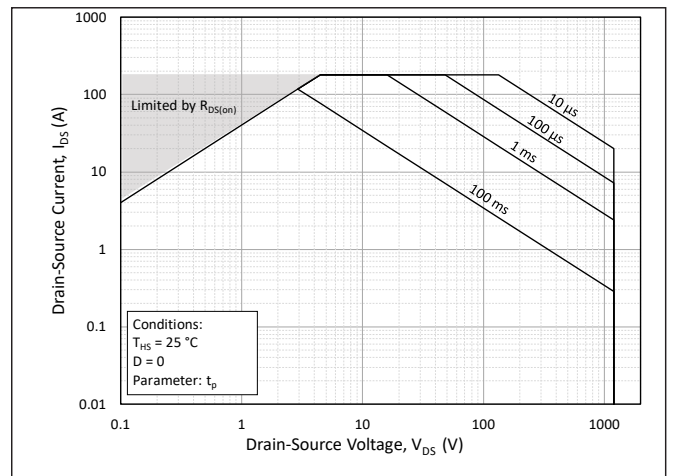

Figure 18. Forward Bias Safe Operating Area (FBSOA)



Typical Performance

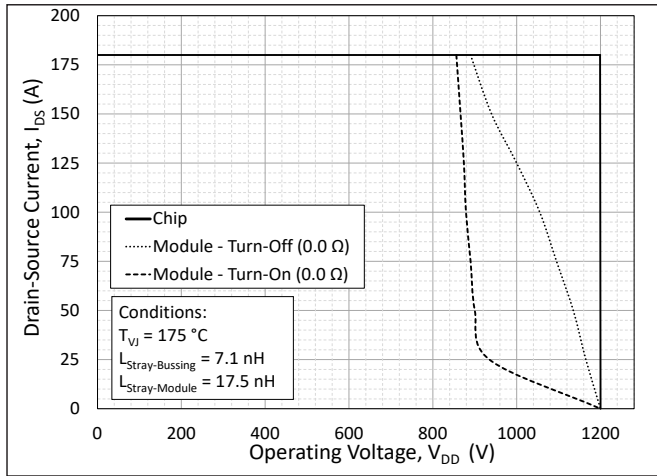

Figure 19. Switching Safe Operating Area

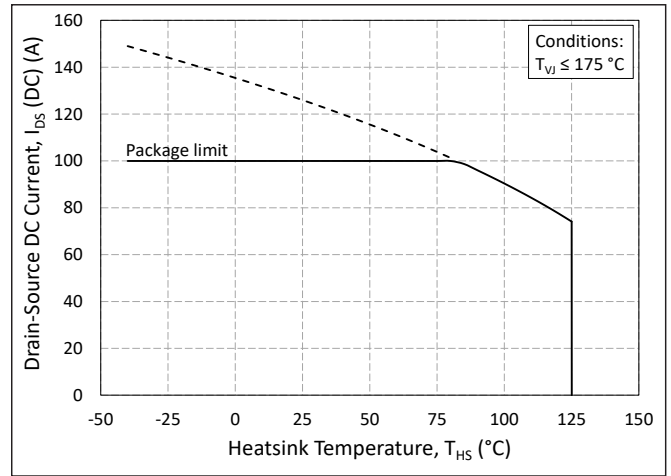

Figure 20. Continuous Drain Current Derating vs. Case Temperature

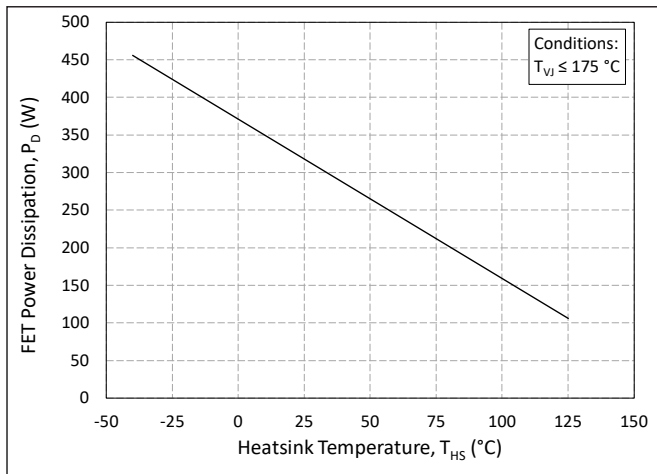

Figure 21. Maximum Power Dissipation Derating vs. Case Temperature

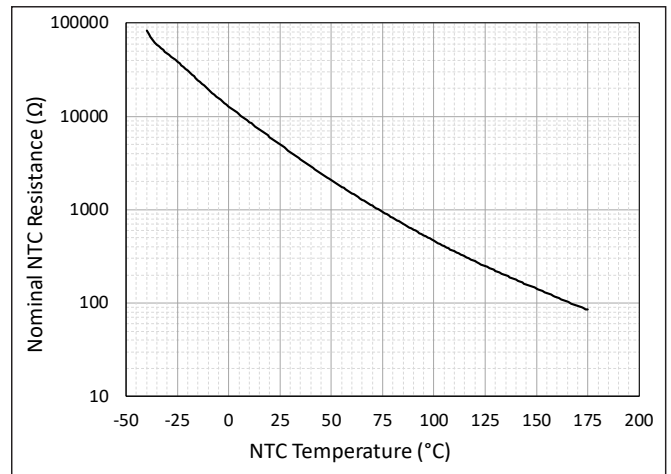

Figure 22. Nominal NTC Resistance vs. NTC Temperature

Note (6): Figures 1-10 are representative of the static MOSFET characteristics for all four switch positions.

Note (7): Figures 11-28 are representative of switch positions M11 and M14 (page 10) corresponding to the top-side high-frequency loop. The circuits for switching loss and reverse recovery measurements are shown in figures 33 and 34.

Note (8): The CGD1700HB2M-UNA, which features the UCC21710 gate driver IC from Texas Instruments, was used to evaluate dynamic performance. The typical parasitic turn-on resistance of 2.5 Ω and the parasitic turn-off resistance of 0.3 Ω are not included in the $R_{G(ext)}$ values on this datasheet.



Timing Characteristics

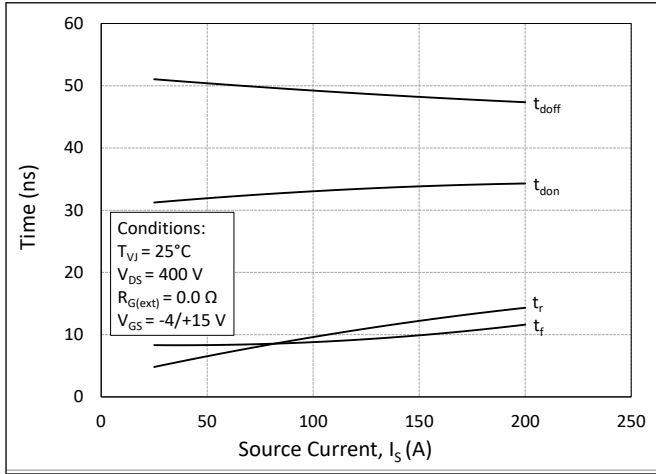

Figure 23. Timing vs. Source Current

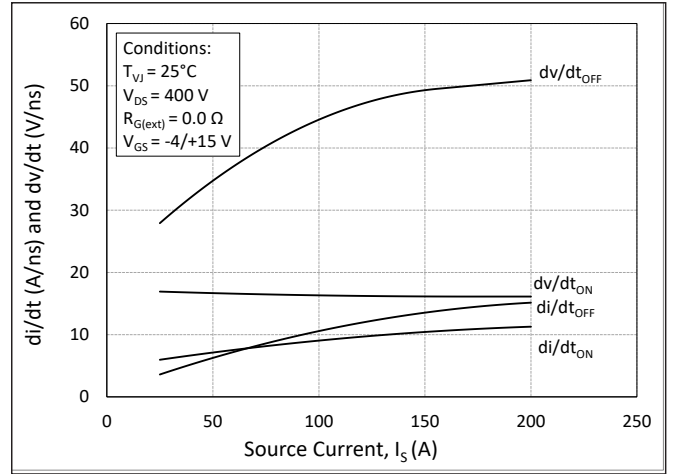

Figure 24. dv/dt and di/dt vs. Source Current

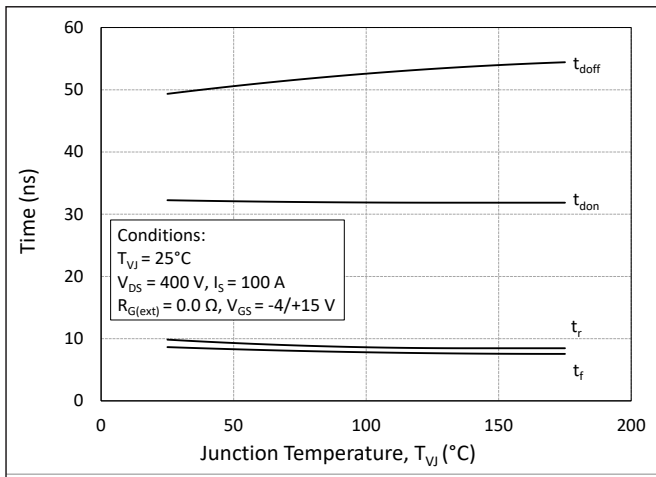

Figure 25. Timing vs. Junction Temperature

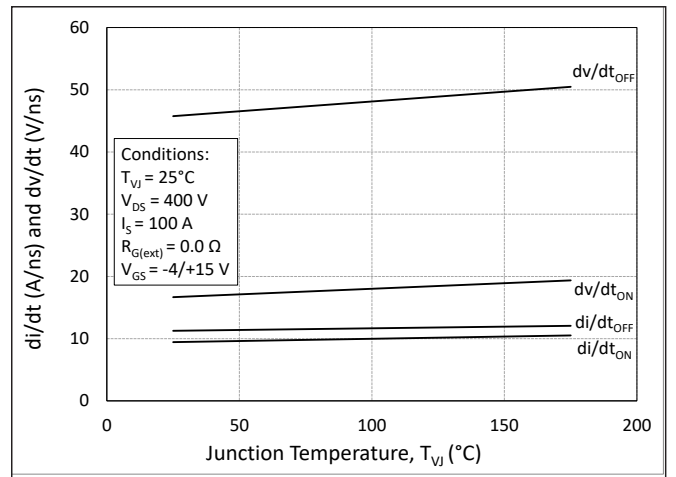

Figure 26. dv/dt and di/dt vs. Junction Temperature

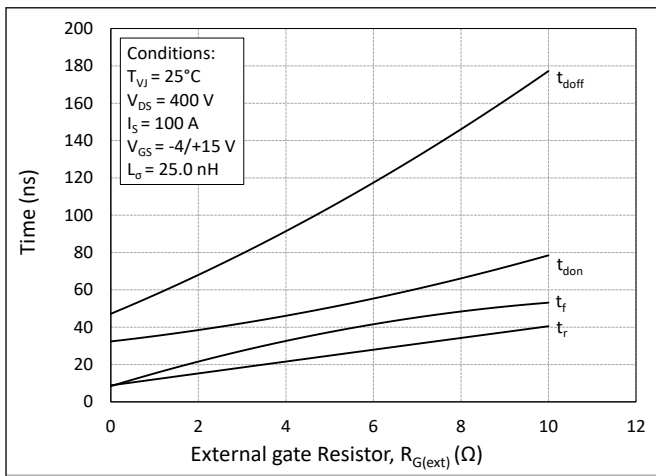

Figure 27. Timing vs. External Gate Resistance

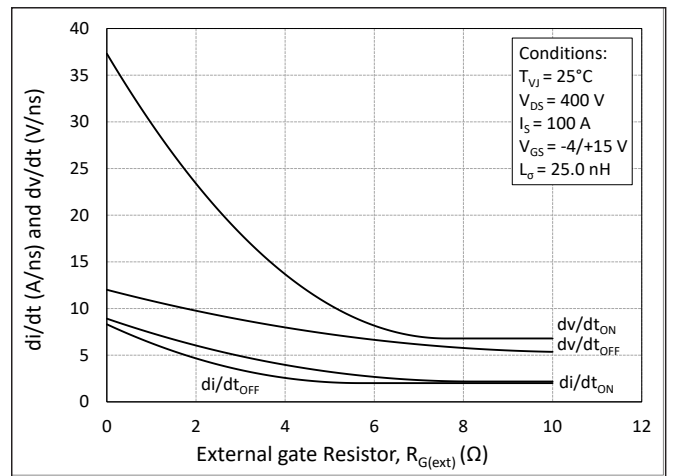

Figure 28. dv/dt and di/dt vs. External Gate Resistance



Definitions

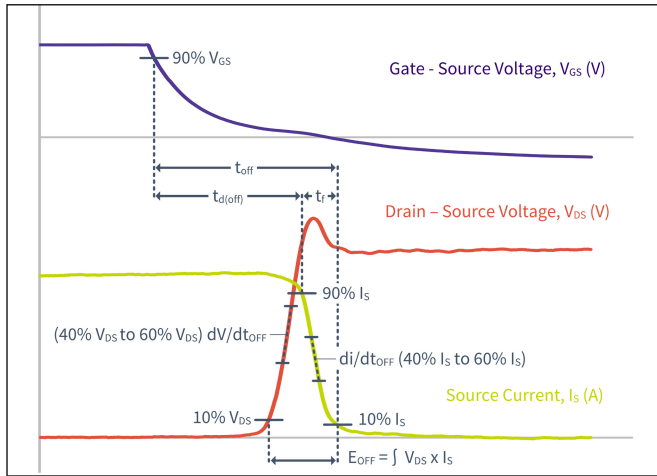

Figure 29. Turn-off Transient Definitions

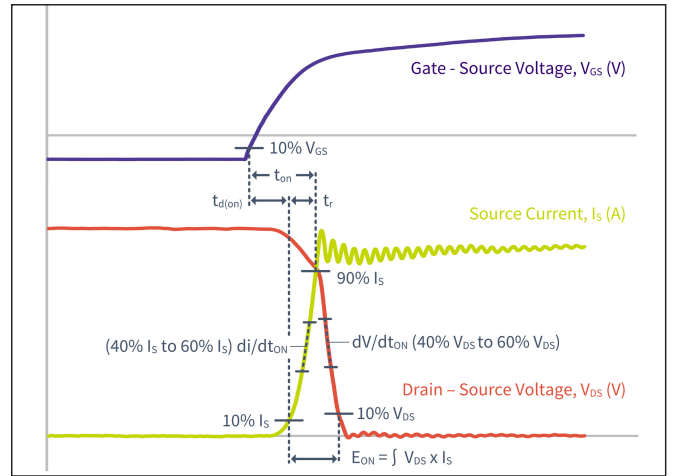

Figure 30. Turn-on Transient Definitions

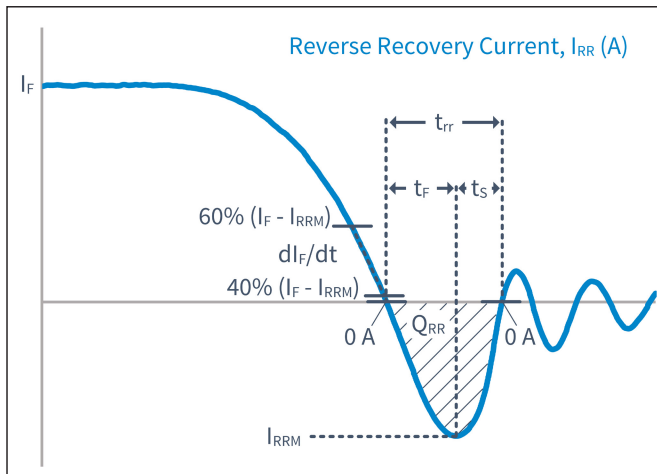

Figure 31. Reverse Recovery Definitions

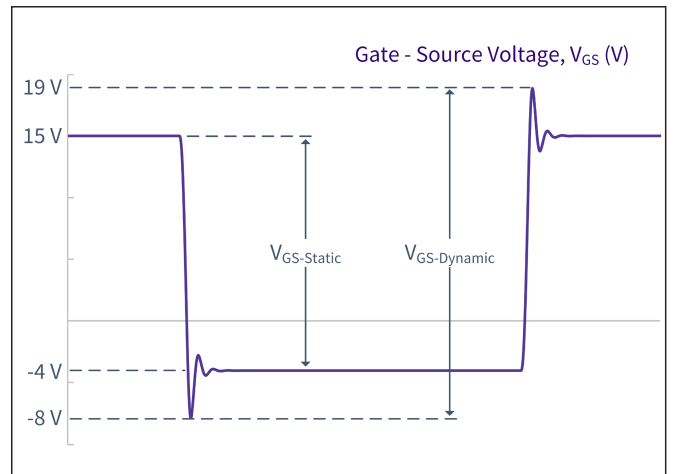

Figure 32. V_GS Transient Definitions

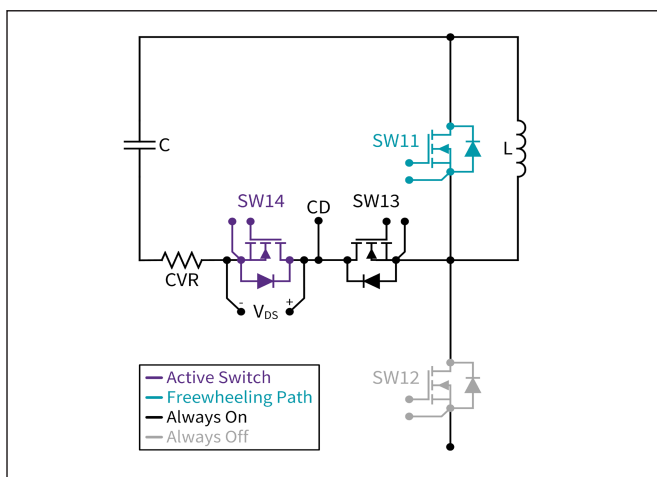

Figure 33. Switching Loss Measurement

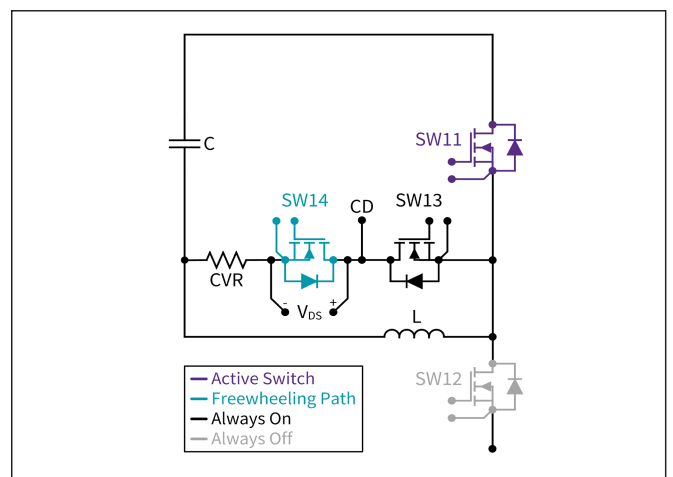
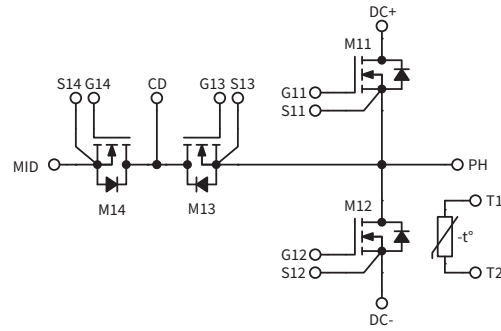
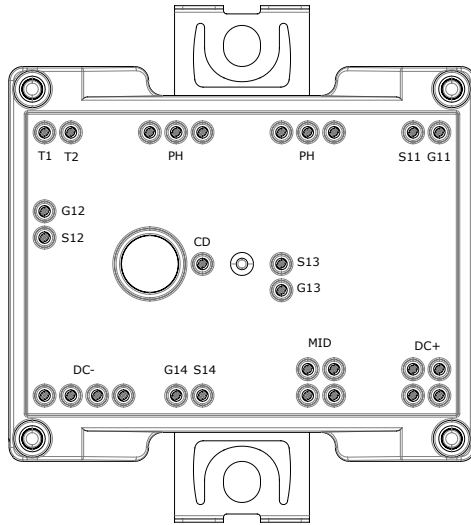

Figure 34. Reverse Recovery Measurement



Schematic and Pin Out



Package Dimension (mm)

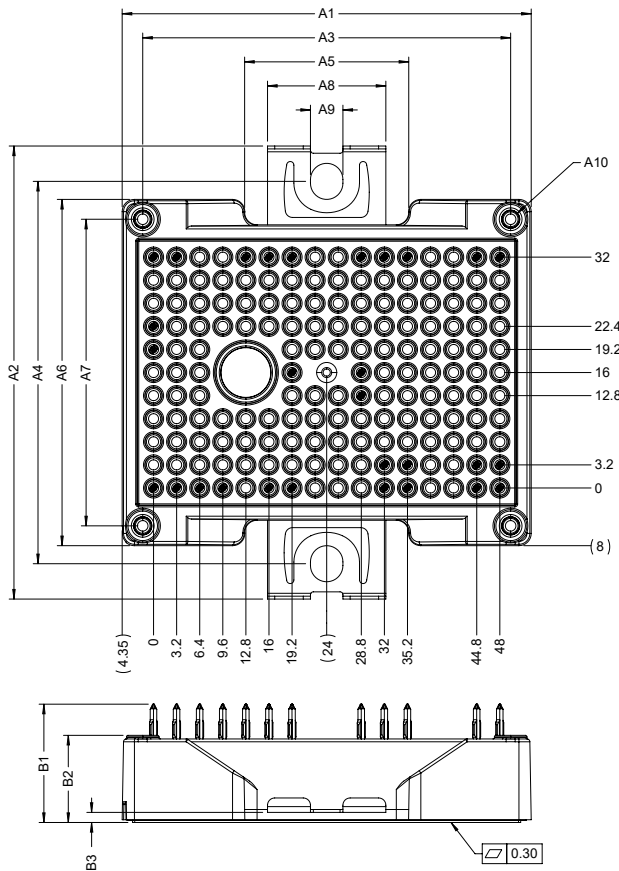

| DIMENSION TABLE | | |
|-------------------|-----------|--|
| SYMBOL | DIMENSION | TOLERANCE |
| A1 | 56.7 | ±0.30 |
| A2 | 62.8 | ±0.50 |
| A3 | 51 | ±0.15 |
| A4 | (53) | REF. |
| A5 | 22.7 | ±0.30 |
| A6 | 48 | ±0.30 |
| A7 | 42.5 | ±0.15 |
| A8 | 16.4 | ±0.20 |
| A9 | 4.5 | ±0.10 |
| A10 | ∅2.3 ∓8.5 | ∅: $\begin{matrix} +0 \\ -0.10 \end{matrix}$ ∓: ±0.30 |
| B1 | 16.4 | ±0.50 |
| B2 | 12.0 | ±0.35 |
| B3 | 1.4 | ±0.20 |
| ALL PIN LOCATIONS | | ±0.40 |



Product Ordering Code

| Part Number | Description |
|---------------|---|
| CHB011M12GM4 | Without Pre-Applied Phase Change Thermal Interface Material |
| CHB011M12GM4T | With Pre-Applied Phase Change Thermal Interface Material |

Supporting Links & Tools

Evaluation Tools & Support

- [All LTSpice Models](#)
- [All PLECS Models](#)
- [SpeedFit 2.0 Design Simulator™](#)
- [Technical Support Forum](#)

Dual-Channel Gate Driver Board

- [EVAL-ADUM4146WHB1Z: Analog Devices® Gate Driver Board](#)
- [Si823H-AxWA-KIT: Skyworks® Gate Driver Board](#)
- [ACPL-355JC: Broadcom® Gate Driver Board](#)
- [CGD1700HB2M-UNA: Wolfspeed Gate Driver Board](#)
- [CGD12HB00D: Differential Transceiver Daughter Board Companion Tool for Differential Gate Drivers](#)

Application Notes

- [CPWR-AN41: Mounting Instructions and PCB Requirements](#)
- [CPWR-AN42: Thermal Interface Material Application Note](#)
- [CPWR-AN45: Dynamic Performance Application Note](#)



Notes & Disclaimers

WOLFSPEED PROVIDES TECHNICAL AND RELIABILITY DATA, DESIGN RESOURCES, APPLICATION OR OTHER DESIGN ADVICE, WEB TOOLS, AND OTHER RESOURCES “AS IS” AND WITH ALL FAULTS, AND DISCLAIMS ALL WARRANTIES, EXPRESS AND IMPLIED, WITH RESPECT THERETO, INCLUDING WITHOUT LIMITATION ANY IMPLIED WARRANTIES OF MERCHANTABILITY, SUITABILITY, FITNESS FOR A PARTICULAR PURPOSE, OR NON-INFRINGEMENT OF THIRD-PARTY INTELLECTUAL PROPERTY RIGHTS.

This document and the information contained herein are subject to change without notice. Any such change shall be evidenced by the publication of an updated version of this document by Wolfspeed. No communication from any employee or agent of Wolfspeed or any third party shall effect an amendment or modification of this document. No responsibility is assumed by Wolfspeed for any infringement of patents or other rights of third parties which may result from use of the information contained herein. No license is granted by implication or otherwise under any patent or patent rights of Wolfspeed.

The information contained in this document (excluding examples, as well as figures or values that are labeled as “typical”) constitutes Wolfspeed’s sole published specifications for the subject product. “Typical” parameters are the average values expected by Wolfspeed in large quantities and are provided for informational purposes only. Any examples provided herein have not been produced under conditions intended to replicate any specific end use. Product performance can and does vary due to a number of factors.

This product has not been designed or tested for use in, and is not intended for use in, any application in which failure of the product would reasonably be expected to cause death, personal injury, or property damage. For purposes of (but without limiting) the foregoing, this product is not designed, intended, or authorized for use as a critical component in equipment implanted into the human body, life-support machines, cardiac defibrillators, and similar emergency medical equipment; air traffic control systems; or equipment used in the planning, construction, maintenance, or operation of nuclear facilities. Notwithstanding any application-specific information, guidance, assistance, or support that Wolfspeed may provide, the buyer of this product is solely responsible for determining the suitability of this product for the buyer’s purposes, including without limitation (1) selecting the appropriate Wolfspeed products for the buyer’s application, (2) designing, validating, and testing the buyer’s application, and (3) ensuring the buyer’s application meets applicable standards and any other legal, regulatory, and safety-related requirements.

RoHS Compliance

The levels of RoHS restricted materials in this product are below the maximum concentration values (also referred to as the threshold limits) permitted for such substances, or are used in an exempted application, in accordance with EU Directive 2011/65/EC (RoHS2), as implemented January 2, 2013. RoHS Declarations for this product can be obtained from your Wolfspeed representative or from the Product Documentation sections of www.wolfspeed.com.

REACH Compliance

REACH substances of high concern (SVHCs) information is available for this product. Since the European Chemical Agency (ECHA) has published notice of their intent to frequently revise the SVHC listing for the foreseeable future, please contact your Wolfspeed representative to ensure you get the most up-to-date REACH SVHC Declaration. REACH banned substance information (REACH Article 67) is also available upon request.

Contact info:

4600 Silicon Drive
Durham, NC 27703 USA
Tel: +1.919.313.5300
www.wolfspeed.com/power