

HAS530M12BM3, HAS530M12BM3T

1200 V, 530 A, Silicon Carbide, Half-Bridge Module

V_{DS}	1200 V
I_{DS}	530 A

Technical Features

- Industry Standard 62 mm Footprint
- Housing CTI ≥ 600 (Material Group I)
- Compliant with EN45545-2 R22/23 HL3
- High Humidity Operation THB-80 (HV-H3TRB)
- Low Inductance Design Optimized for SiC
- Ultra Low Loss, High-Frequency Operation
- Normally-off, Fail-safe Device Operation
- Copper Baseplate and Aluminum Nitride Insulator

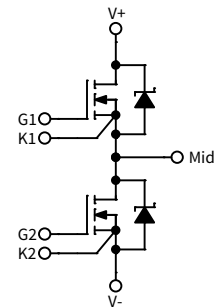
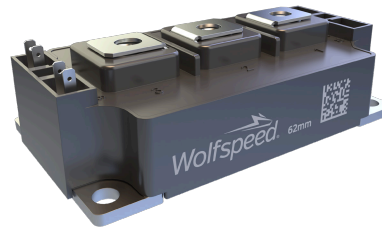

Typical Applications

- Railway Auxiliary & Traction
- Induction Heating
- Motor Drives
- Renewables
- EV Fast Charging
- UPS and SMPS

System Benefits

- 62 mm Form Factor Enables System Retrofit
- Increased System Efficiency, due to Low Switching & Conduction Losses of SiC
- Zero Reverse Recovery from Schottky Diodes
- Zero Turn-off Tail Current from MOSFET

Key Parameters

Parameter	Symbol	Min.	Typ.	Max.	Unit	Conditions	Note
Drain-Source Voltage	V_{DS}			1200	V		
Gate-Source Voltage, Maximum Value	$V_{GS(max)}$	-10		+23		Transient	Note 1 Fig. 33
Gate-Source Voltage, Recommended	$V_{GS(op)}$		-4/+15			Static	
DC Continuous Drain Current	I_D		645		A	$V_{GS} = 15\text{ V}, T_C = 25\text{ }^\circ\text{C}, T_{VJ} \leq 175\text{ }^\circ\text{C}$	Notes 2, 3 Fig. 21
			486			$V_{GS} = 15\text{ V}, T_C = 90\text{ }^\circ\text{C}, T_{VJ} \leq 175\text{ }^\circ\text{C}$	
DC Source-Drain Current (Schottky Diode)	$I_{SD(SD)}$		632			$V_{GS} = -4\text{ V}, T_C = 25\text{ }^\circ\text{C}, T_{VJ} \leq 175\text{ }^\circ\text{C}$	
Pulsed Drain-Source Current	I_{DM}		1060			t_{Pmax} limited by T_{VJmax} $V_{GS} = 15\text{ V}, T_C = 25\text{ }^\circ\text{C}$	
Power Dissipation	P_D		2000		W	$T_C = 25\text{ }^\circ\text{C}, T_{VJ} \leq 175\text{ }^\circ\text{C}$	Note 4 Fig. 21
Virtual Junction Temperature	$T_{VJ(op)}$	-40		150	$^\circ\text{C}$	Operation	
				175		Intermittent with Reduced Life	

Note (1): Recommended turn-on gate voltage is 15 V with $\pm 5\%$ regulation tolerance. Not for use in linear region.

Note (2): Current limit calculated by $I_{D(max)} = \sqrt{(P_D/R_{DS(typ)}(T_{VJ(max)}, I_{D(max)}))}$

Note (3): Verified by design

Note (4): $P_D = (T_{VJ} - T_C)/R_{TH(JC, typ)}$

MOSFET Characteristics (Per Position) ($T_{VJ} = 25\text{ °C}$ Unless Otherwise Specified)

Parameter	Symbol	Min.	Typ.	Max.	Unit	Conditions	Note
Drain-Source Breakdown Voltage	$V_{(BR)DSS}$	1200				$V_{GS} = 0\text{ V}$, $T_{VJ} = -40\text{ °C}$	
Gate Threshold Voltage	$V_{GS(th)}$	1.8	2.5	3.6	V	$V_{DS} = V_{GS}$, $I_D = 127\text{ mA}$	
			2.0			$V_{DS} = V_{GS}$, $I_D = 127\text{ mA}$, $T_{VJ} = 175\text{ °C}$	
Zero Gate Voltage Drain Current	I_{DSS}		12.8	1692	μA	$V_{GS} = 0\text{ V}$, $V_{DS} = 1200\text{ V}$	
Gate-Source Leakage Current	I_{GSS}		60	600	nA	$V_{GS} = 15\text{ V}$, $V_{DS} = 0\text{ V}$	
Drain-Source On-State Resistance (Devices Only)	$R_{DS(on)}$		2.7	3.5	m Ω	$V_{GS} = 15\text{ V}$, $I_D = 530\text{ A}$	Fig. 2 Fig. 3
			4.3			$V_{GS} = 15\text{ V}$, $I_D = 530\text{ A}$, $T_{VJ} = 150\text{ °C}$	
			4.8			$V_{GS} = 15\text{ V}$, $I_D = 530\text{ A}$, $T_{VJ} = 175\text{ °C}$	
Transconductance	g_{fs}		449		S	$V_{DS} = 20\text{ V}$, $I_D = 530\text{ A}$	Fig. 4
			418			$V_{DS} = 20\text{ V}$, $I_D = 530\text{ A}$, $T_{VJ} = 150\text{ °C}$	
Turn-On Switching Energy, $T_{VJ} = 25\text{ °C}$ $T_{VJ} = 125\text{ °C}$ $T_{VJ} = 150\text{ °C}$	E_{ON}		6.6 6.0 6.0		mJ	$V_{DD} = 600\text{ V}$, $I_D = 530\text{ A}$, $V_{GS} = -4\text{ V}/15\text{ V}$, $R_{G(OFF)} = 0.5\ \Omega$, $R_{G(ON)} = 0.5\ \Omega$, $L = 13.6\ \mu\text{H}$	Fig. 11 Fig. 13
Turn-Off Switching Energy, $T_{VJ} = 25\text{ °C}$ $T_{VJ} = 125\text{ °C}$ $T_{VJ} = 150\text{ °C}$	E_{OFF}		8.9 9.0 9.0				
Internal Gate Resistance	$R_{G(int)}$		1.68		Ω	$f = 100\text{ kHz}$	
Input Capacitance	C_{iss}		38.9		nF	$V_{GS} = 0\text{ V}$, $V_{DS} = 800\text{ V}$, $V_{AC} = 25\text{ mV}$, $f = 100\text{ kHz}$	Fig. 9
Output Capacitance	C_{oss}		2.6				
Reverse Transfer Capacitance	C_{rss}		48.5		pF		
Gate to Source Charge	Q_{GS}		384		nC	$V_{DS} = 800\text{ V}$, $V_{GS} = -4\text{ V}/15\text{ V}$, $I_D = 530\text{ A}$, Per IEC60747-8-4 pg 21	
Gate to Drain Charge	Q_{GD}		462				
Total Gate Charge	Q_G		1362				
FET Thermal Resistance, Junction to Case	$R_{th\ JC}$		0.075		$^{\circ}\text{C}/\text{W}$		Fig. 17

Diode Characteristics (Per Position) ($T_{VJ} = 25\text{ °C}$ Unless Otherwise Specified)

Parameter	Symbol	Min.	Typ.	Max.	Unit	Conditions	Note
Diode Forward Voltage	V_F		2.0		V	$V_{GS} = -4\text{ V}$, $I_F = 530\text{ A}$, $T_{VJ} = 25\text{ °C}$	Fig. 7
			2.6			$V_{GS} = -4\text{ V}$, $I_F = 530\text{ A}$, $T_{VJ} = 150\text{ °C}$	
Reverse Recovery Time	t_{RR}		25.5		ns		
Reverse Recovery Charge	Q_{RR}		4.8		μC	$V_{GS} = -4\text{ V}$, $I_{SD} = 530\text{ A}$, $V_R = 800\text{ V}$ $di/dt = 18.0\text{ A/ns}$, $T_{VJ} = 150\text{ °C}$	Fig. 32
Peak Reverse Recovery Current	I_{RRM}		324		A		
Reverse Recovery Energy, $T_{VJ} = 25\text{ °C}$ $T_{VJ} = 125\text{ °C}$ $T_{VJ} = 150\text{ °C}$	E_{RR}		1.9 2.2 2.2		mJ	$V_{DS} = 600\text{ V}$, $I_D = 530\text{ A}$, $V_{GS} = -4\text{ V}/15\text{ V}$, $R_{G(ext)} = 0.5\ \Omega$, $L = 13.6\ \mu\text{H}$	Fig. 14 Note 5
Diode Thermal Resistance, JCT. to Case	$R_{th\ JC}$		0.078		$^{\circ}\text{C}/\text{W}$		Fig. 18

Note (5): SiC Schottky diodes do not have reverse recovery energy but still contribute capacitive energy



Module Physical Characteristics

Parameter	Symbol	Min.	Typ.	Max.	Unit	Conditions	
Package Resistance, M1 (High-Side)	R ₃₋₁		0.90		mΩ	T _C = 25 °C, I _{SD} = 530 A, Note 6	
			1.26			T _C = 125 °C, I _{SD} = 530 A, Note 6	
Package Resistance, M2 (Low-Side)	R ₁₋₂		0.97	T _C = 25 °C, I _{SD} = 530 A, Note 6			
			1.36	T _C = 125 °C, I _{SD} = 530 A, Note 6			
Stray Inductance	L _{Stray}		11.1		nH	Between DC- and DC+, f = 10 MHz	
Case Temperature	T _C	-40		125	°C		
Mounting Torque	M _S		4	5	5.5	N-m	Baseplate, M6-1.0 Bolts
			4	5	5.5		Power Terminals, M6-1.0 Bolts
Weight	W		300		g		
Case Isolation Voltage	V _{isol}	5			kV	AC, 50 Hz, 1 minute	
Comparative Tracking Index	CTI	600					
Clearance Distance			9		mm	Terminal to Terminal	
			30			Terminal to Baseplate	
Creepage Distance			30			Terminal to Terminal	
			40			Terminal to Baseplate	

Note (6): Total Effective Resistance (Per Switch Position) = MOSFET R_{DS(on)} + Switch Position Package Resistance



Typical Performance

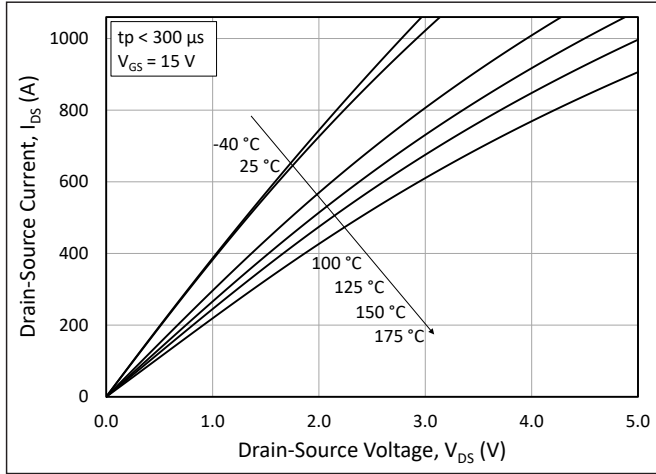

Figure 1. Output Characteristics for Various Junction Temperatures

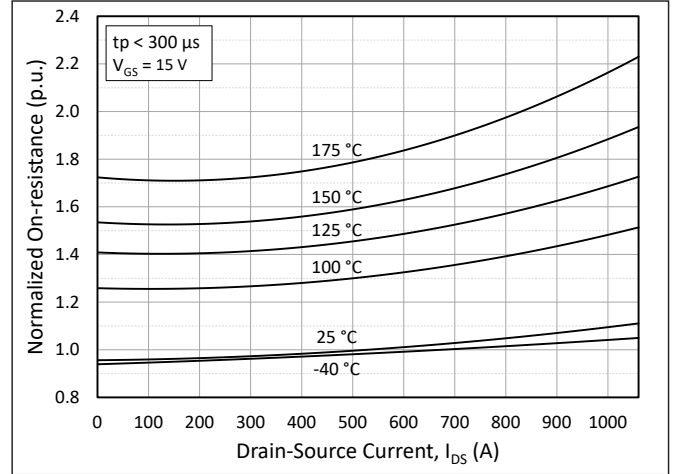

Figure 2. Normalized On-State Resistance vs. Drain Current for Various Junction Temperatures

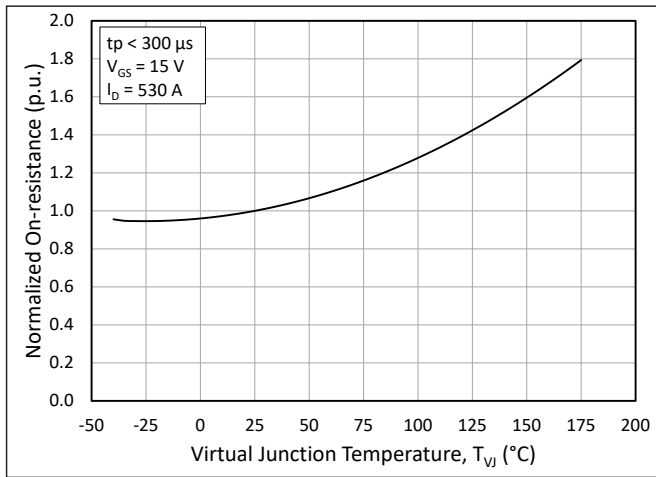

Figure 3. Normalized On-State Resistance vs. Junction Temperature

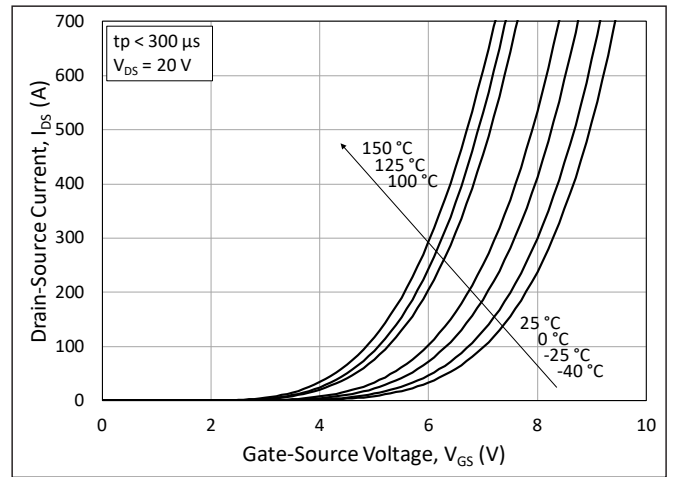

Figure 4. Transfer Characteristic for Various Junction Temperatures

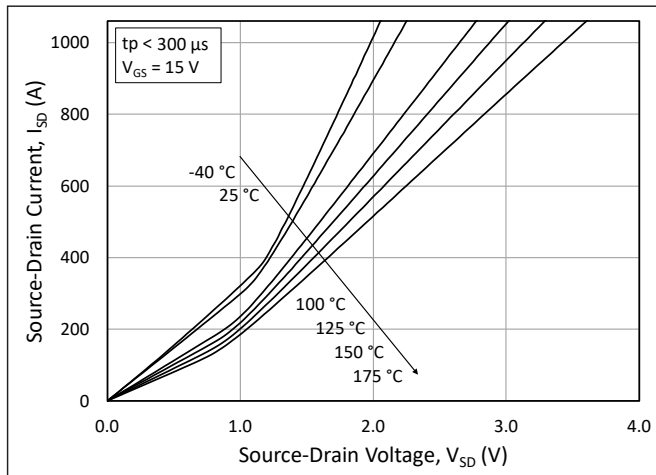

Figure 5. 3rd Quadrant Characteristic vs. Junction Temperatures at $V_{GS} = 15\text{ V}$

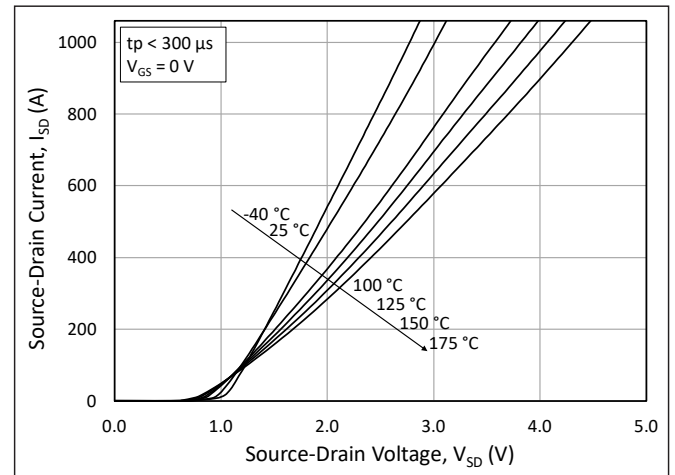

Figure 6. 3rd Quadrant Characteristic vs. Junction Temperatures at $V_{GS} = 0\text{ V}$ (Diode)



Typical Performance

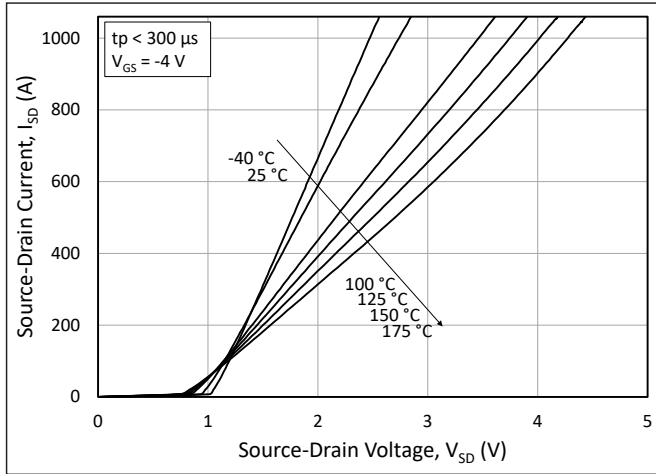

Figure 7. 3rd Quadrant Characteristic vs. Junction Temperatures at $V_{GS} = -4$ V (Diode)

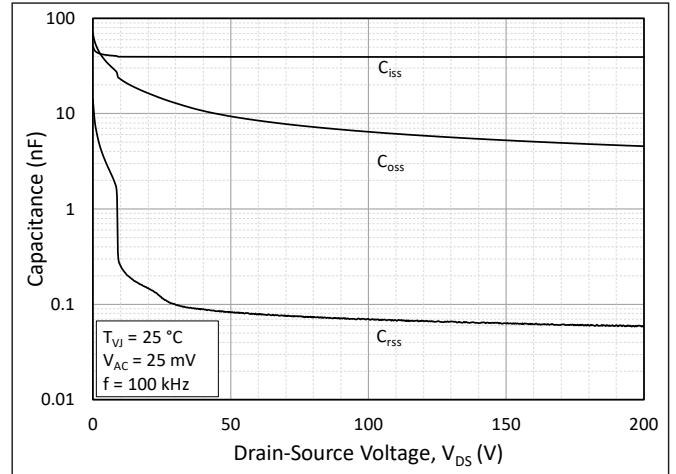

Figure 8. Typical Capacitances vs. Drain to Source Voltage (0 - 200 V)

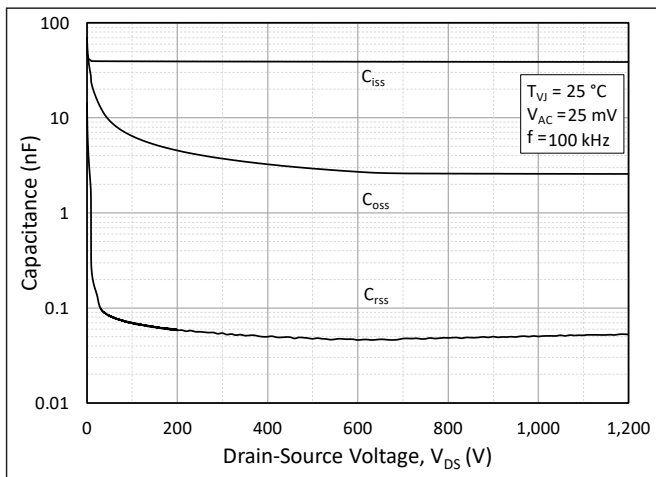

Figure 9. Typical Capacitances vs. Drain to Source Voltage (0 - 1200 V)

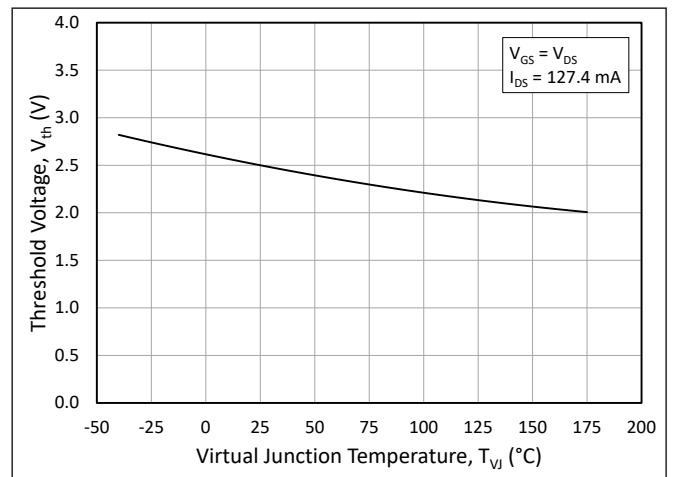

Figure 10. Threshold Voltage vs. Junction Temperature

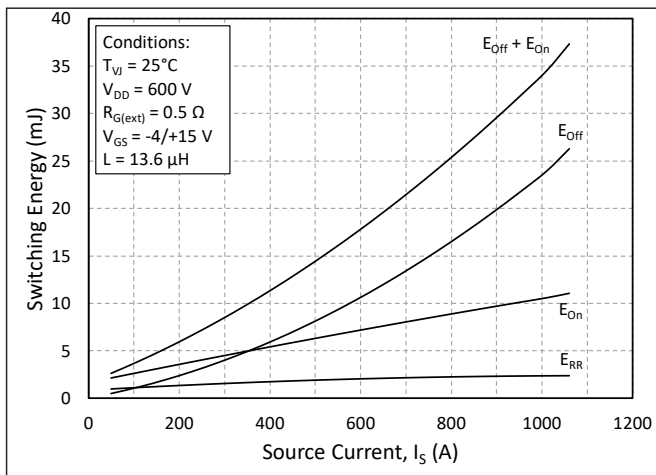

Figure 11. Switching Energy vs. Drain Current ($V_{DS} = 600$ V)

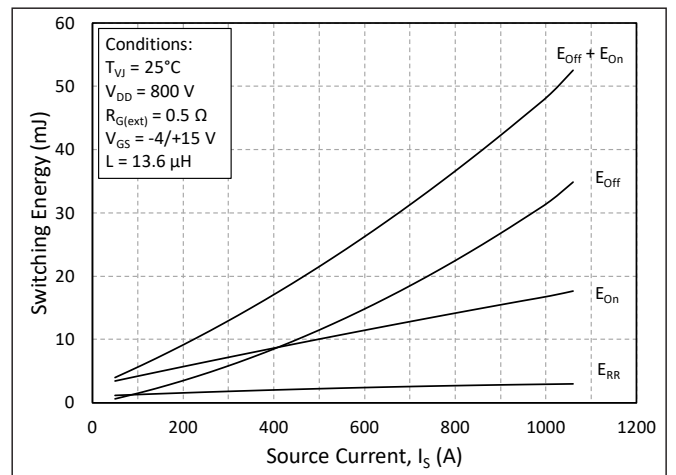

Figure 12. Switching Energy vs. Drain Current ($V_{DS} = 800$ V)



Typical Performance

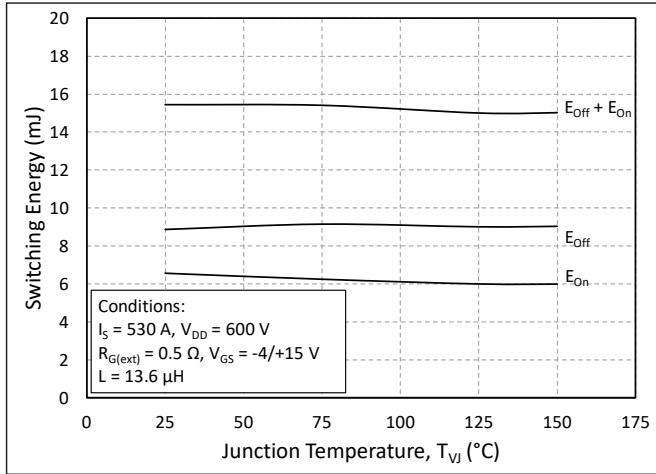

Figure 13. MOSFET Switching Energy vs. Junction Temperature

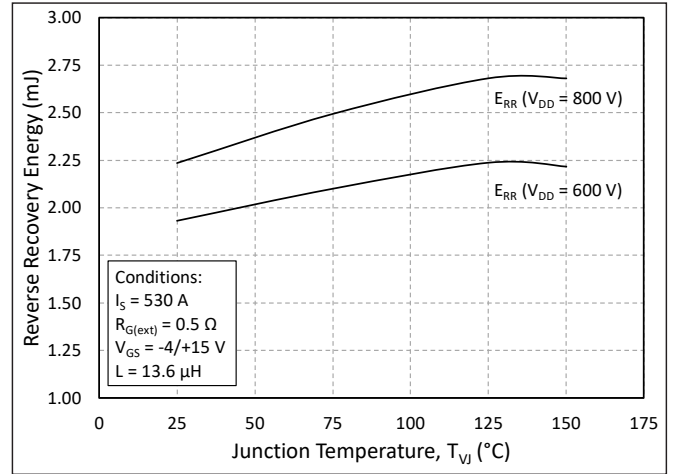

Figure 14. Reverse Recovery Energy vs. Junction Temperature

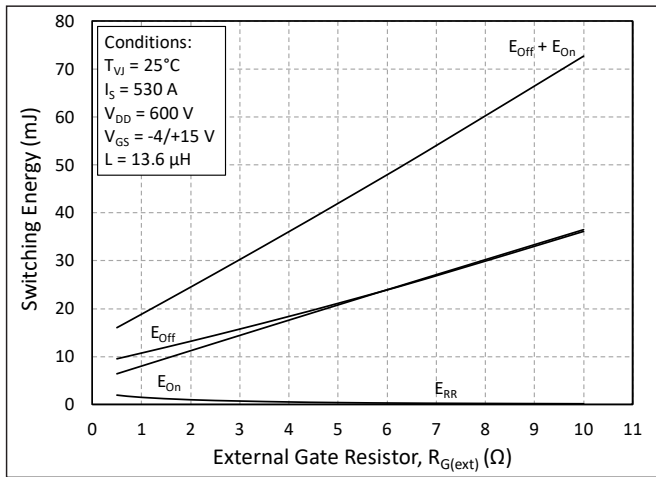

Figure 15. MOSFET Switching Energy vs. External Gate Resistance

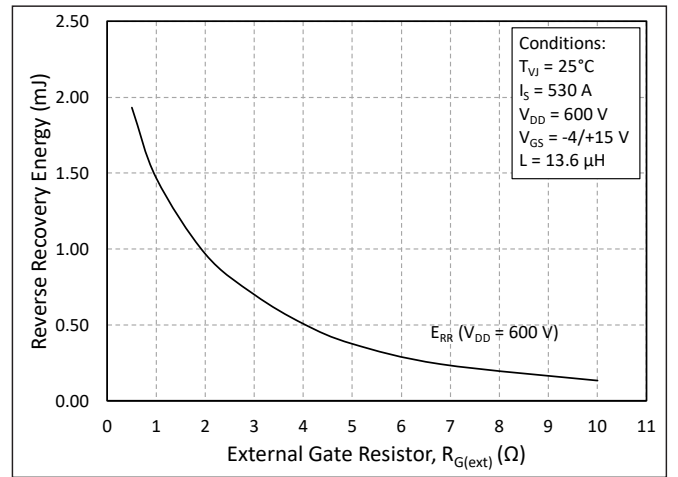

Figure 16. Reverse Recovery Energy vs. External Gate Resistance

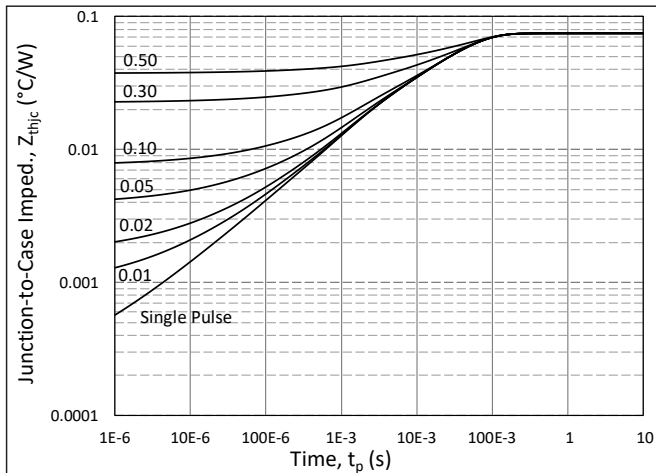

Figure 17. MOSFET Junction to Case Transient Thermal Impedance, Z_{thjc} (°C/W)

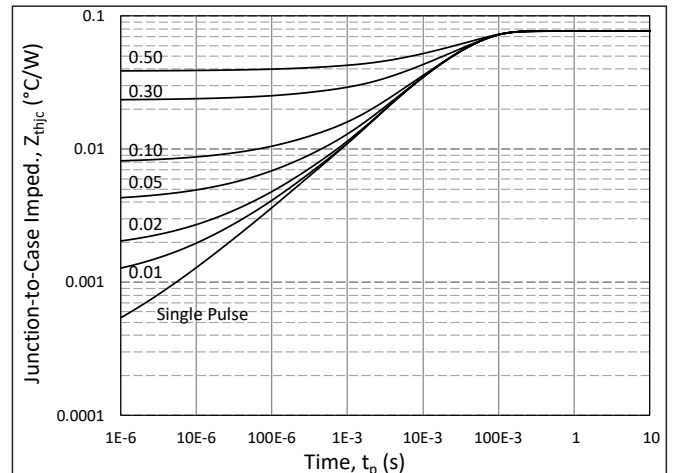

Figure 18. Diode Junction to Case Transient Thermal Impedance, Z_{thjc} (°C/W)



Typical Performance

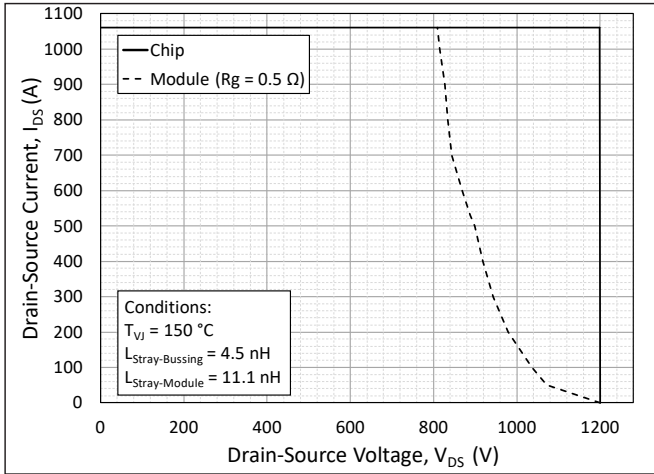

Figure 19. Switching Safe Operating Area

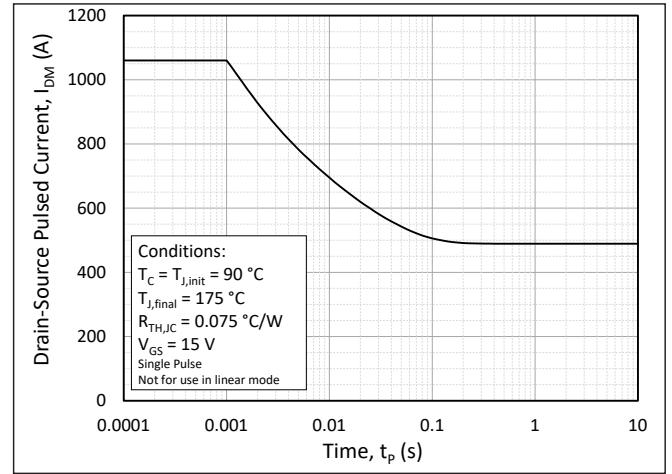

Figure 20. Pulsed Current Safe Operating Area

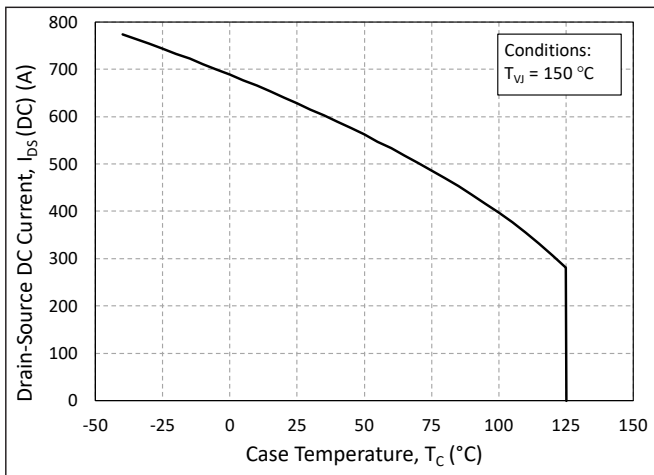

Figure 21. Continuous Drain Current Derating vs. Case Temperature

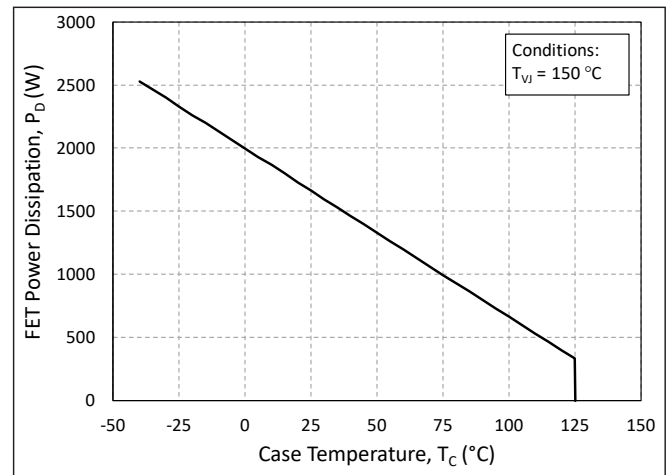

Figure 22. Maximum Power Dissipation Derating vs. Case Temperature

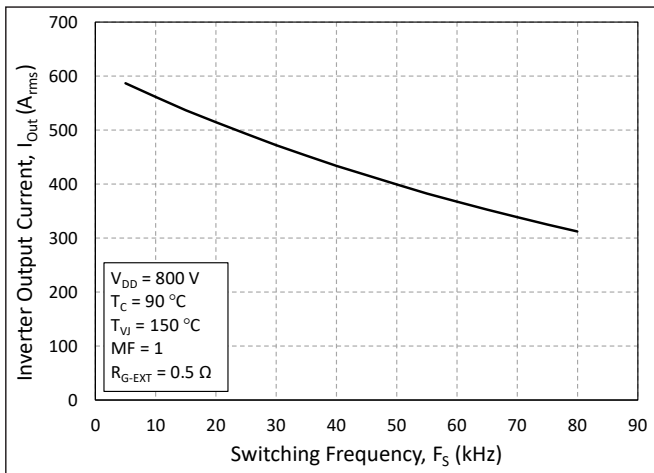

Figure 23. Typical Output Current Capability vs. Switching Frequency (Inverter Application)



Timing Characteristics

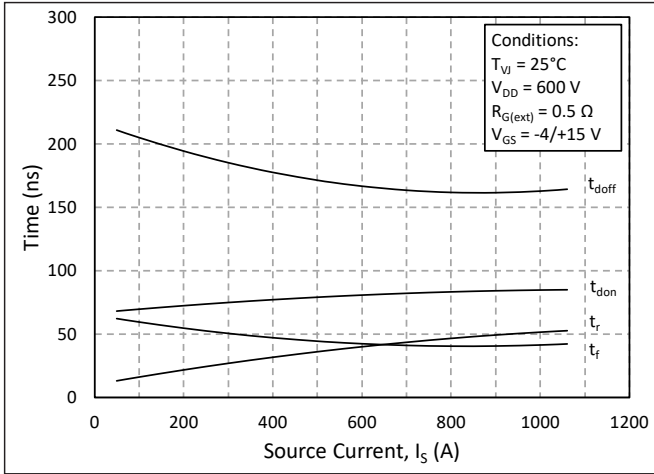

Figure 24. Timing vs. Source Current

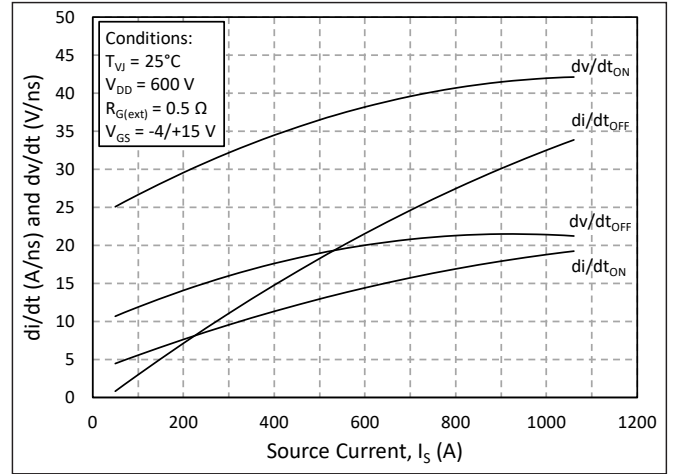

Figure 25. dv/dt and di/dt vs. Source Current

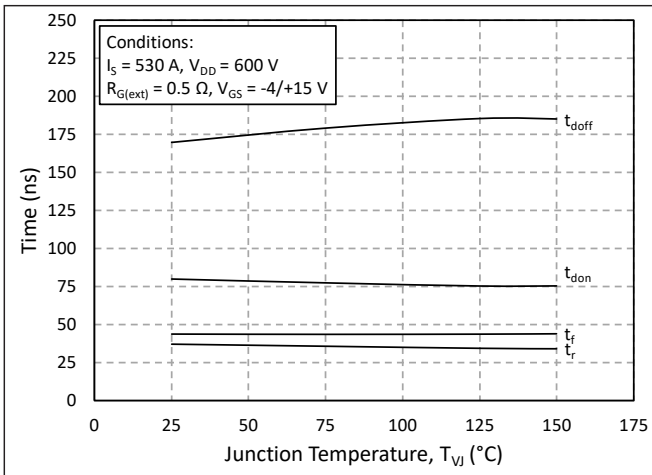

Figure 26. Timing vs. Junction Temperature

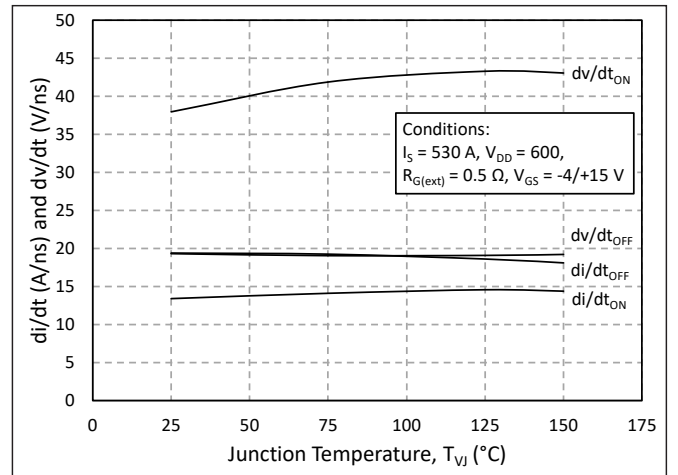

Figure 27. dv/dt and di/dt vs. Junction Temperature

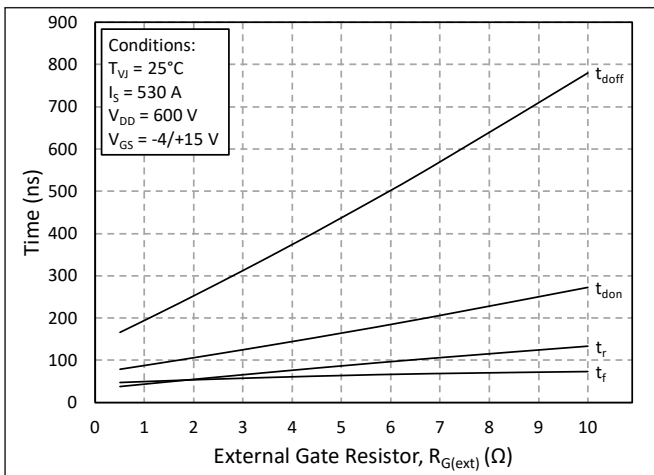

Figure 28. Timing vs. External Gate Resistance

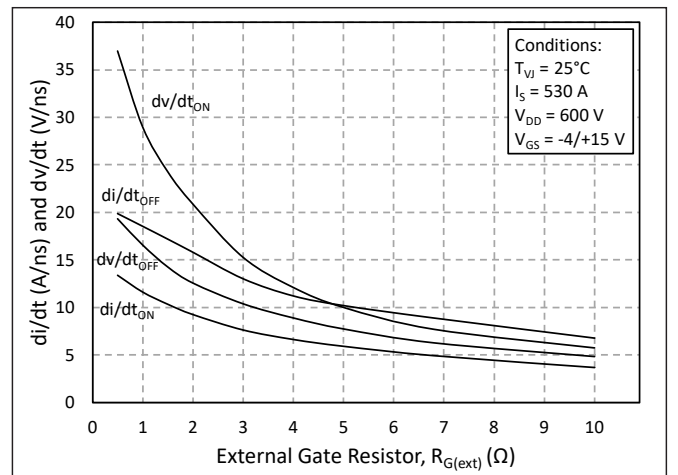

Figure 29. dv/dt and di/dt vs. External Gate Resistance



Definitions

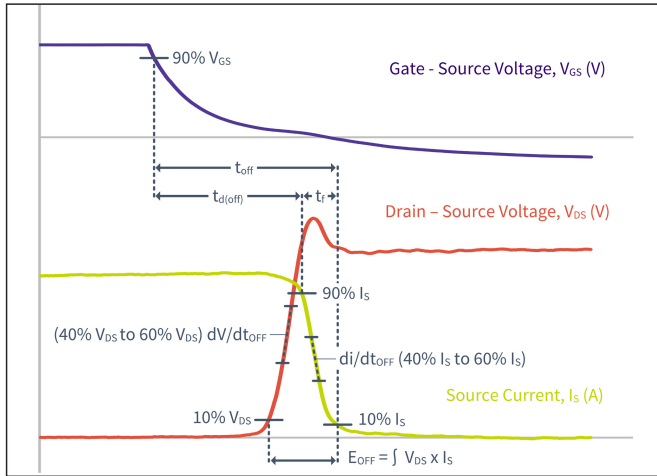

Figure 30. Turn-Off Transient Definitions

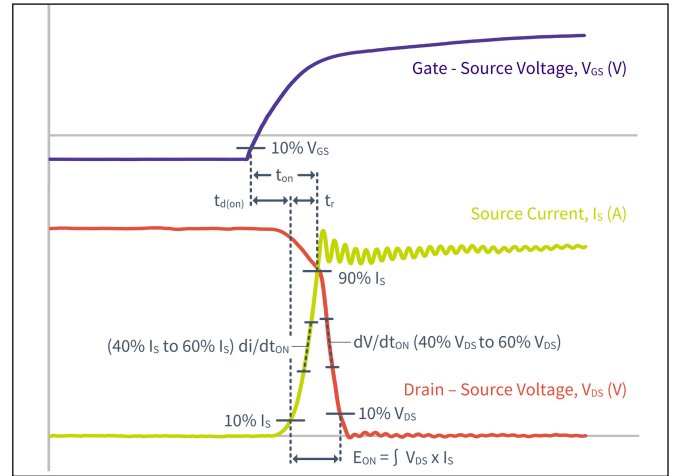

Figure 31. Turn-On Transient Definitions

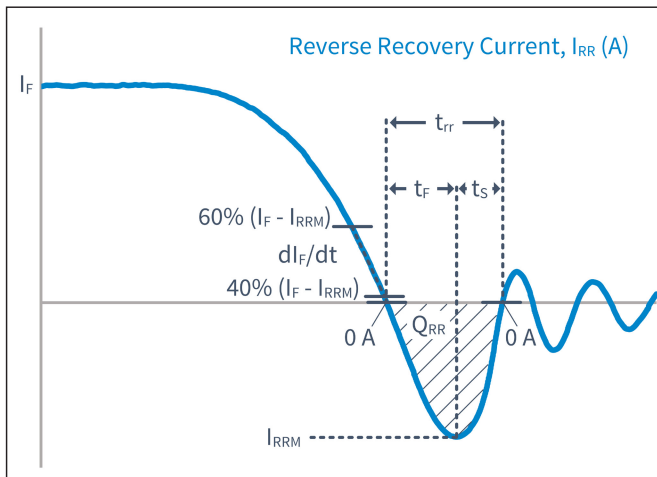

Figure 32. Reverse Recovery Definitions

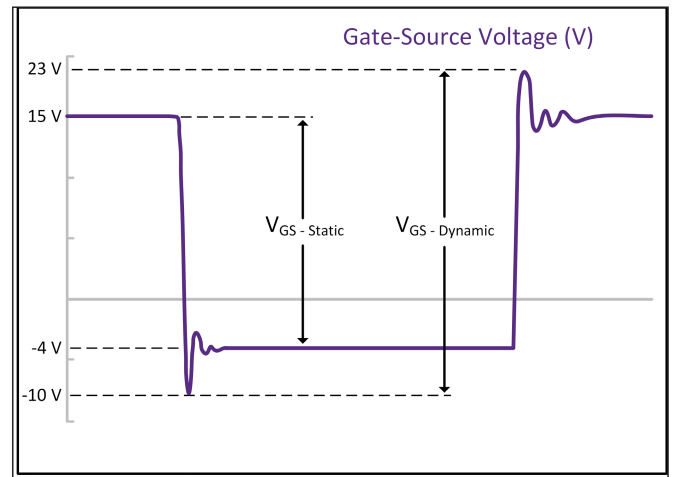
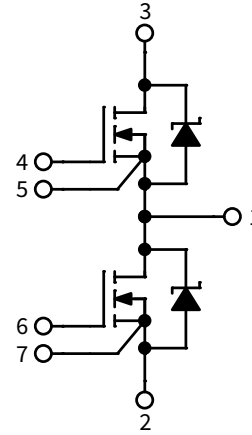
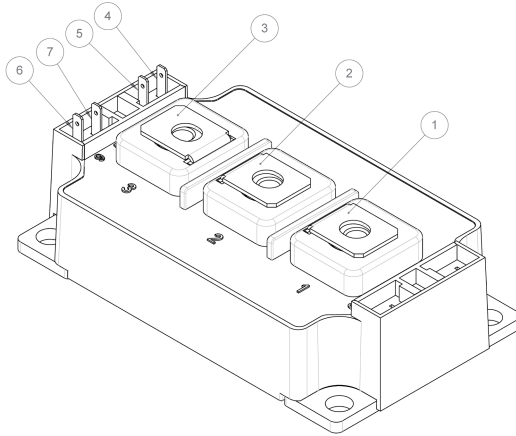

Figure 33. V_{GS} Transient Definitions



Schematic and Pin Out



Package Dimension (mm)

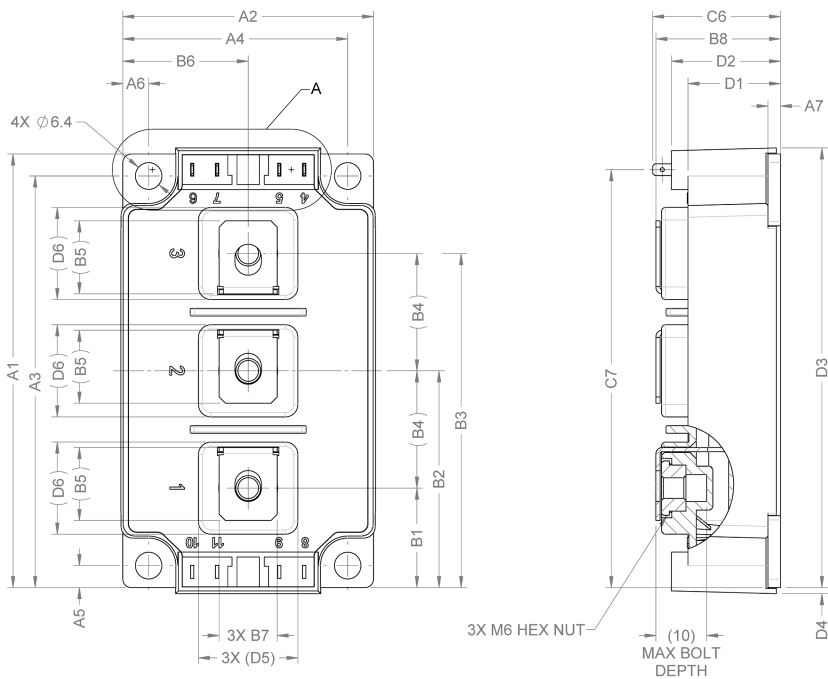

DIMENSION TABLE		
SYMBOL	DIMENSION	TOLERANCE
A1	103.5	±0.30
A2	60.44	±0.30
A3	98.25	±0.30
A4	54.22	±0.30
A5	5.25	±0.30
A6	6.22	±0.30
A7	3	±0.30
B1	23.75	±0.40
B2	51.75	±0.40
B3	79.75	±0.40
B4	(28)	REF.
B5	(17.43)	REF.
B6	30.23	±0.40
B7	(14)	REF.
B8	30.03	±0.40
C1	16.73	±0.40
C2	22.73	±0.40
C3	37.73	±0.40
C4	43.73	±0.40
C5	2.8	±0.40
C6	30.8	±0.50
C7	99.75	±0.40
C8	(6)	REF.
C9	(15)	REF.
D1	22.3	±0.30
D2	26.3	±0.30
D3	104.95	±0.30
D4	1.45	±0.40
D5	(24)	REF.
D6	(22)	REF.

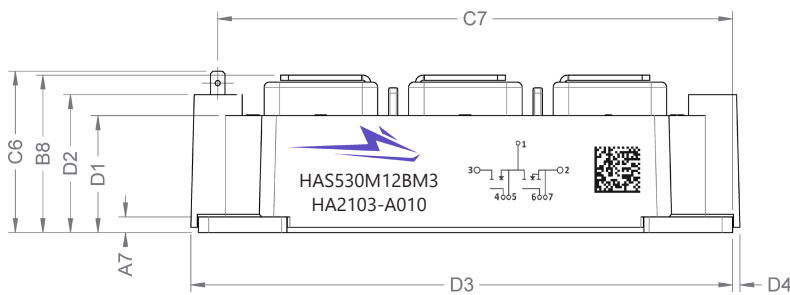



Product Ordering Code

Part Number	Description
HAS530M12BM3	Without Pre-Applied Phase Change Thermal Interface Material
HAS530M12BM3T	With Pre-Applied Phase Change Thermal Interface Material

Supporting Links & Tools

Simulation Tools & Support

- [All LTSpice Models](#)
- [All PLECS Models](#)
- [SpeedFit 2.0 Design Simulator™](#)
- [Technical Support Forum](#)

Compatible Evaluation Hardware

- [CGD1200HB2P-BM3: Dual Channel Differential Isolated Half Bridge Gate Driver Board](#)
- [KIT-CRD-CIL12N-BM: Dynamic Performance Evaluation Board for the BM2 and BM3 Module](#)
- [CGD1700HB2P-BM3: Evaluation Gate Driver Tool Optimized for the 1700 V BM3 Power Modules](#)
- [KIT-CRD-CIL17N-BM: Dynamic Characterization Evaluation Tool Optimized for 1700 V BM Power Modules](#)
- [CGD12HB00D: Differential Transceiver Daughter Board Companion Tool for Differential Gate Drivers](#)

Application Notes

- [PRD-07933: Wolfspeed Power Module Thermal Interface Material Application User Guide](#)
- [PRD-06379: Environmental Considerations for Power Electronics](#)
- [PRD-08710: Measuring Stray Inductance in Power Electronic Systems](#)
- [PRD-07845: Power Module Baseplate Capacitance and Electromagnetic Compatibility](#)
- [PRD-08376: Thermal Characterization Methods and Applications](#)
- [PRD-06933: Capacitance Ratio and Parasitic Turn-On](#)



Notes & Disclaimers

WOLFSPEED PROVIDES TECHNICAL AND RELIABILITY DATA, DESIGN RESOURCES, APPLICATION OR OTHER DESIGN ADVICE, WEB TOOLS, AND OTHER RESOURCES “AS IS” AND WITH ALL FAULTS, AND DISCLAIMS ALL WARRANTIES, EXPRESS AND IMPLIED, WITH RESPECT THERETO, INCLUDING WITHOUT LIMITATION ANY IMPLIED WARRANTIES OF MERCHANTABILITY, SUITABILITY, FITNESS FOR A PARTICULAR PURPOSE, OR NON-INFRINGEMENT OF THIRD-PARTY INTELLECTUAL PROPERTY RIGHTS.

This document and the information contained herein are subject to change without notice. Any such change shall be evidenced by the publication of an updated version of this document by Wolfspeed. No communication from any employee or agent of Wolfspeed or any third party shall effect an amendment or modification of this document. No responsibility is assumed by Wolfspeed for any infringement of patents or other rights of third parties which may result from use of the information contained herein. No license is granted by implication or otherwise under any patent or patent rights of Wolfspeed.

The information contained in this document (excluding examples, as well as figures or values that are labeled as “typical”) constitutes Wolfspeed’s sole published specifications for the subject product. “Typical” parameters are the average values expected by Wolfspeed in large quantities and are provided for informational purposes only. Any examples provided herein have not been produced under conditions intended to replicate any specific end use. Product performance can and does vary due to a number of factors.

This product has not been designed or tested for use in, and is not intended for use in, any application in which failure of the product would reasonably be expected to cause death, personal injury, or property damage. For purposes of (but without limiting) the foregoing, this product is not designed, intended, or authorized for use as a critical component in equipment implanted into the human body, life-support machines, cardiac defibrillators, and similar emergency medical equipment; air traffic control systems; or equipment used in the planning, construction, maintenance, or operation of nuclear facilities. Notwithstanding any application-specific information, guidance, assistance, or support that Wolfspeed may provide, the buyer of this product is solely responsible for determining the suitability of this product for the buyer’s purposes, including without limitation (1) selecting the appropriate Wolfspeed products for the buyer’s application, (2) designing, validating, and testing the buyer’s application, and (3) ensuring the buyer’s application meets applicable standards and any other legal, regulatory, and safety-related requirements.

RoHS Compliance

The levels of RoHS restricted materials in this product are below the maximum concentration values (also referred to as the threshold limits) permitted for such substances, or are used in an exempted application, in accordance with EU Directive 2011/65/EC (RoHS2), as implemented January 2, 2013. RoHS Declarations for this product can be obtained from your Wolfspeed representative or from the Product Documentation sections of www.wolfspeed.com.

REACH Compliance

REACH substances of high concern (SVHCs) information is available for this product. Since the European Chemical Agency (ECHA) has published notice of their intent to frequently revise the SVHC listing for the foreseeable future, please contact your Wolfspeed representative to ensure you get the most up-to-date REACH SVHC Declaration. REACH banned substance information (REACH Article 67) is also available upon request.

Contact info:

4600 Silicon Drive
Durham, NC 27703 USA
Tel: +1.919.313.5300
www.wolfspeed.com/power