

E6D20065A

E-Series Automotive
650 V, 20 A Silicon Carbide Schottky Diode

Description

With the performance advantages of a Silicon Carbide (SiC) Schottky Barrier diode, power electronics systems can expect to meet higher efficiency standards than Si-based solutions, while also reaching higher frequencies and power densities. SiC diodes can be easily paralleled to meet various application demands, without concern of thermal runaway. In combination with the reduced cooling requirements and improved thermal performance of SiC products, SiC diodes are able to provide lower overall system costs in a variety of diverse applications.



Part Number	Package	Marking
E6D20065A	TO-220-2	E6D20065A

Features

- Low Forward Voltage (V_f) Drop with Positive Temperature Coefficient
- Zero Reverse Recovery Current / Forward Recovery Voltage
- Temperature-Independent Switching Behavior
- Automotive Qualified (AEC Q101) and PPAP Capable

Applications

- Interleaved or Bridgless PFC
- DC/DC On Board Battery Chargers
- Boost for PFC & DC-DC Stages
- AC/DC On Board Chargers
- PFC Output Rectification

Maximum Ratings ($T_c = 25^\circ\text{C}$ Unless Otherwise Specified)

Parameter	Symbol	Value	Unit	Test Conditions	Notes
Repetitive Peak Reverse Voltage	V_{RRM}	650	V		
Surge Peak Reverse Voltage	V_{RSM}	650			
DC Blocking Voltage	V_{DC}	650			
Continuous Forward Current	I_F	68	A	$T_c = 25^\circ\text{C}$	Fig. 3
		34		$T_c = 125^\circ\text{C}$	
		21.5		$T_c = 150^\circ\text{C}$	
Repetitive Peak Forward Surge Current	I_{FRM}	85	A	$T_c = 25^\circ\text{C}, t_p = 10\text{ ms}, \text{Half Sine Wave}$	
		50		$T_c = 110^\circ\text{C}, t_p = 10\text{ ms}, \text{Half Sine Wave}$	
Non-Repetitive Forward Surge Current	I_{FSM}	150	A	$T_c = 25^\circ\text{C}, t_p = 10\text{ ms}, \text{Half Sine Wave}$	
		133		$T_c = 110^\circ\text{C}, t_p = 10\text{ ms}, \text{Half Sine Wave}$	
Power Dissipation	P_{tot}	184	W	$T_c = 25^\circ\text{C}$	Fig. 4
		80		$T_c = 110^\circ\text{C}$	
i^2t value	$\int i^2 dt$	112.5	A^2s	$T_c = 25^\circ\text{C}, t_p = 10\text{ ms}$	
		88		$T_c = 110^\circ\text{C}, t_p = 10\text{ ms}$	

Electrical Characteristics

Parameter	Symbol	Typ.	Max.	Unit	Test Conditions	Notes
Forward Voltage	V_F	1.3	1.5	V	$I_F = 20 \text{ A}, T_j = 25 \text{ }^\circ\text{C}$	Fig. 1
		1.4	1.6		$I_F = 20 \text{ A}, T_j = 175 \text{ }^\circ\text{C}$	
Reverse Current	I_R	7	75	μA	$V_R = 650 \text{ V}, T_j = 25 \text{ }^\circ\text{C}$	Fig. 2
		12	300		$V_R = 650 \text{ V}, T_j = 175 \text{ }^\circ\text{C}$	
Total Capacitive Charge	Q_C	71		nC	$V_R = 400 \text{ V}, T_j = 25 \text{ }^\circ\text{C}$	Fig. 5
Total Capacitance	C	1277		pF	$V_R = 0 \text{ V}, T_j = 25 \text{ }^\circ\text{C}, f = 1 \text{ MHz}$	Fig. 6
		137			$V_R = 200 \text{ V}, T_j = 25 \text{ }^\circ\text{C}, f = 1 \text{ MHz}$	
		107			$V_R = 400 \text{ V}, T_j = 25 \text{ }^\circ\text{C}, f = 1 \text{ MHz}$	
Capacitance Stored Energy	E_C	10.7		μJ	$V_R = 400 \text{ V}$	Fig. 7

Notes:

SIC Schottky Diodes are majority carrier devices, so there is no reverse recovery charge.

Thermal & Mechanical Characteristics

Parameter	Symbol	Value	Unit	Notes
Thermal Resistance, Junction to Case (Typical)	$R_{\theta, JC (TYP)}$	0.625	$^\circ\text{C} / \text{W}$	
Thermal Resistance, Junction to Case (Max)	$R_{\theta, JC (MAX)}$	0.814	$^\circ\text{C} / \text{W}$	
Junction Temperature	T_j	-55 to +175	$^\circ\text{C}$	
Case & Storage Temperature	T_c	-55 to +175		
TO-220 Mounting Torque	-	1	Nm	M3 Screw
		8.8	lbf-in	6-32 Screw

Typical Performance

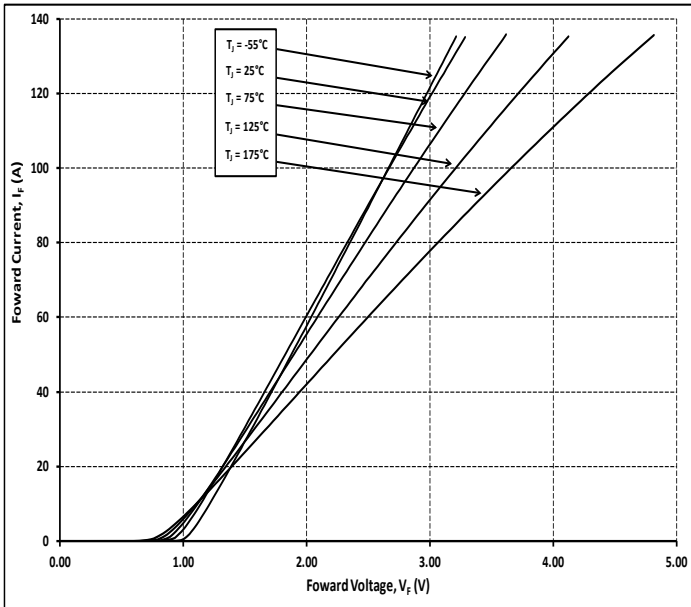

Figure 1
Forward Characteristics

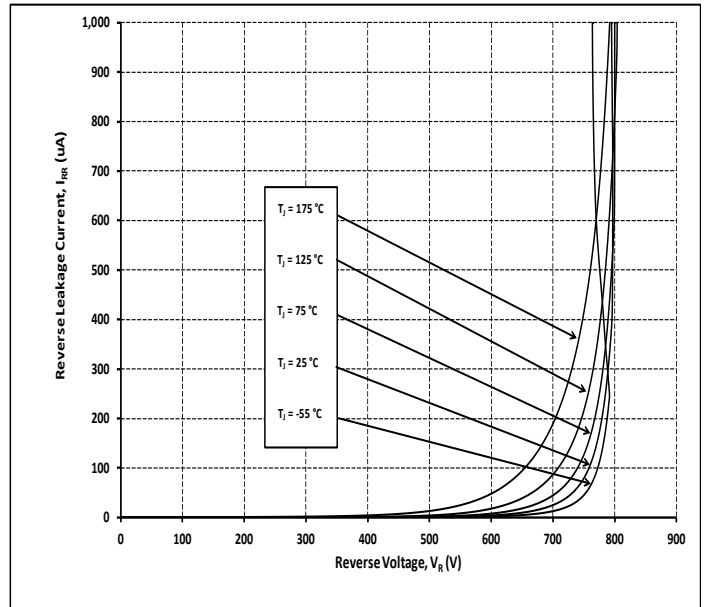

Figure 2
Reverse Characteristics

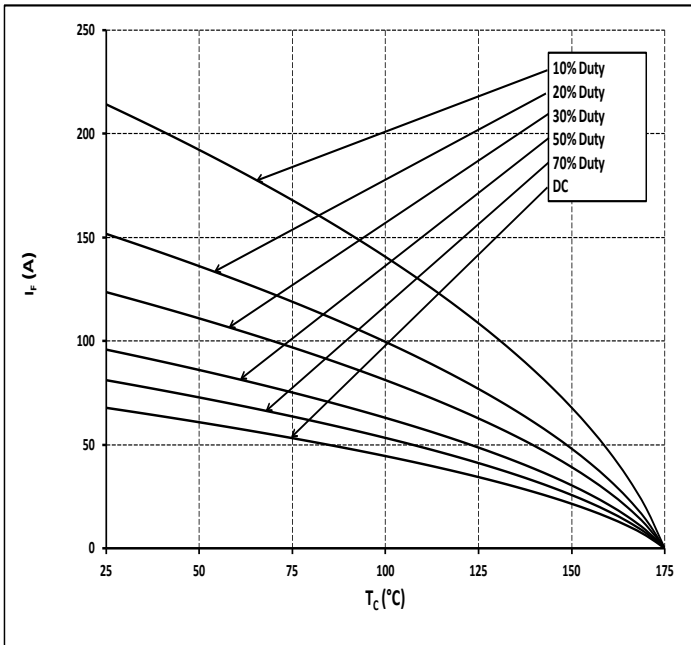

Figure 3
Current Derating

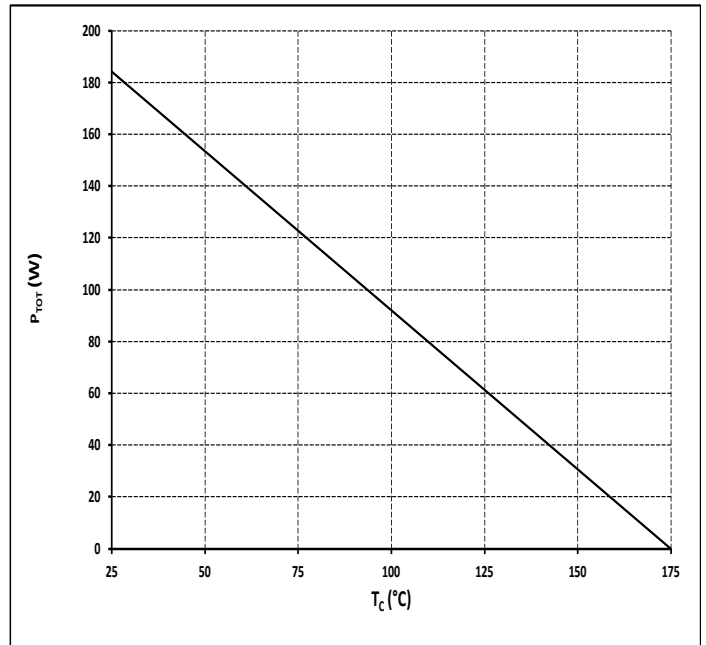

Figure 4
Power Derating

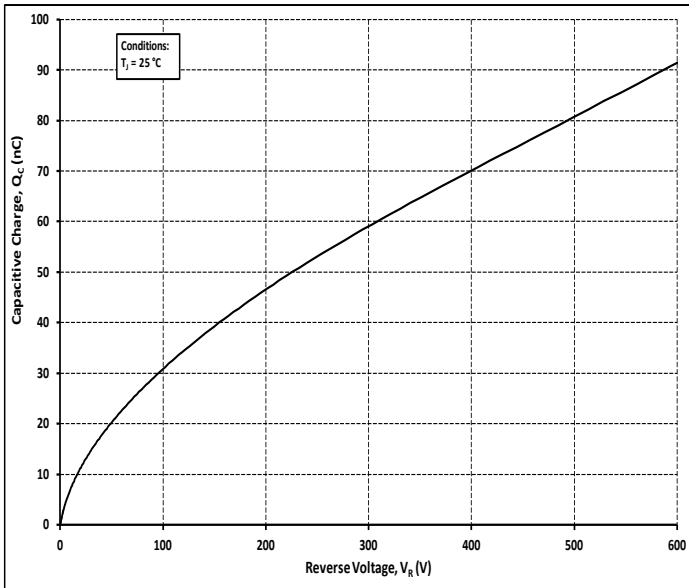

Figure 5
Total Capacitance vs. Reverse Voltage

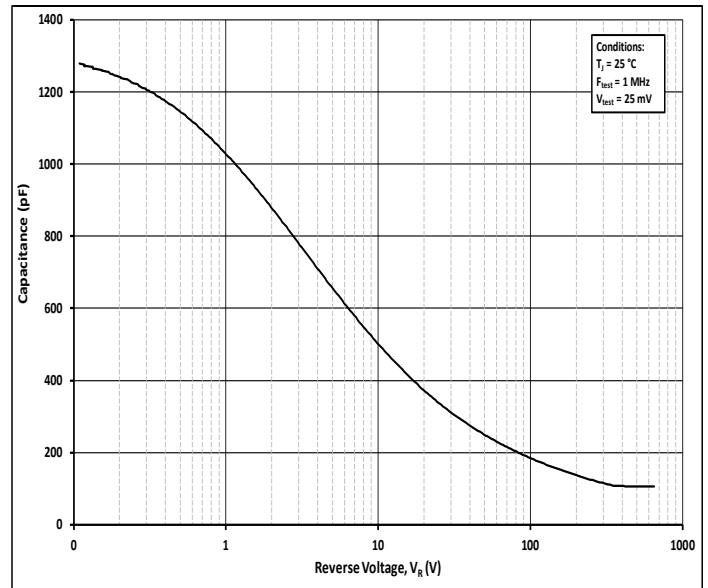

Figure 6
Capacitance vs. Reverse Voltage

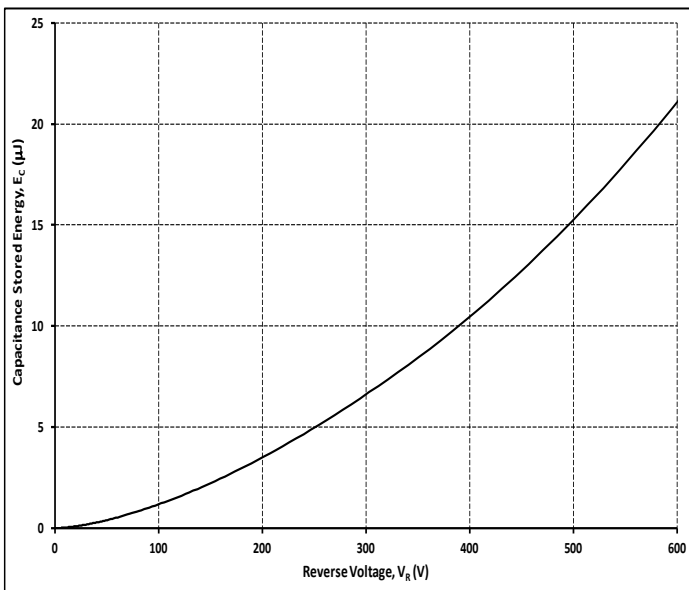

Figure 7
Capacitance Stored Energy

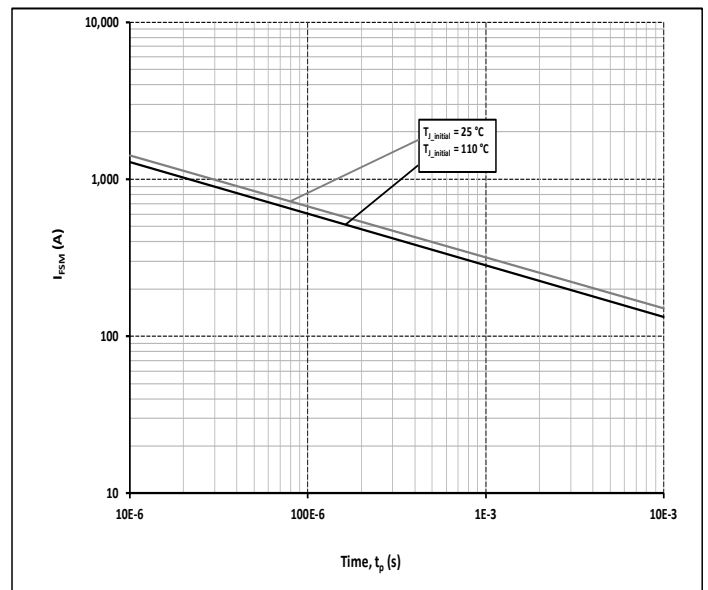

Figure 8
Non Repetitive Peak Forward Surge Current versus Pulse Duration (sinusoidal waveform)

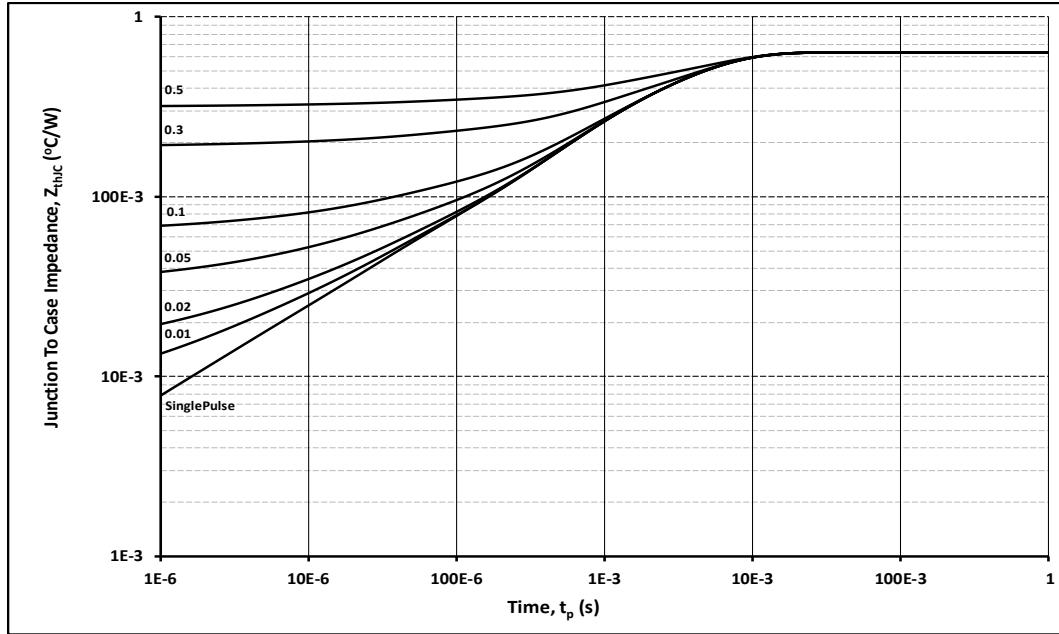
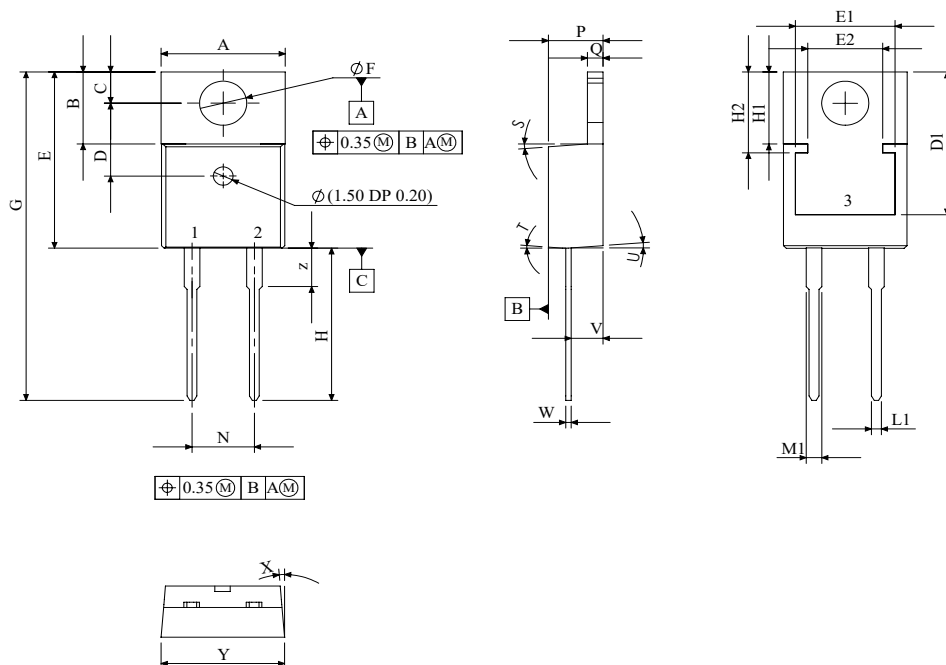

Figure 9
Transient Thermal Impedance

Package Dimensions & Pin-Out

Package: TO-220-2



SYMBOL	MIN (mm)	MAX (mm)
A	9.677	10.414
B	5.969	6.477
C	2.540	3.048
D	5.664	8.560
D1	12.450 REF	
E	14.986	15.621
E1	8.120 REF	
E2	6.100 REF	
F	3.632	3.886
G	28.067	29.134
H	12.700	13.970
H1	6.223 REF	
H2	7.040 REF	
L1	0.635	0.914
M1	1.143	1.397
N	4.953	5.207
P	4.191	4.699
Q	1.219	1.372
S	3°	6°
T	3°	6°
U	3°	6°
V	2.388	2.794
W	0.356	0.635
W1	0.356	0.520
X	3°	5.5°
Y	9.779	10.414
Z	3.302	3.810

1	CATHODE
2	ANODE
3	CATHODE

NOTE

- ALL METAL SURFACES ARE TIN PLATED (MATTE), EXCEPT AREA OF CUT.
- DIMENSIONING & TOLERANCING CONFORM TO ASME Y14.5M-1994.
- ALL DIMENSIONS ARE LISTED IN MILLIMETERS. ANGLES ARE IN DEGREES.
- PACKAGE BURR FLASH SIZE (0.5 mm) IS NOT INCLUDED IN THE DIMENSIONS



Recommended Solder Pad Layout

Primary dimensions shown in mm.

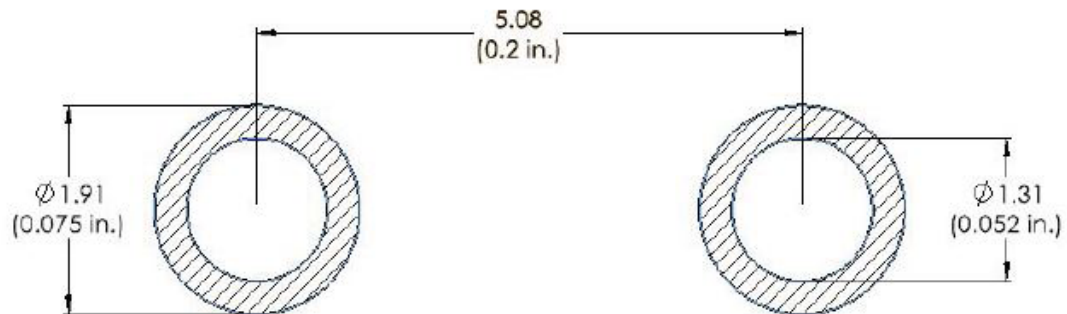

Product Ordering Information

Order Number	Packing Type
E6D20065A	Tube



Revision History

Document Version	Date of Release	Description of Changes
1	January 2024	Initial Release



Notes & Disclaimer

This document and the information contained herein are subject to change without notice. Any such change shall be evidenced by the publication of an updated version of this document by Wolfspeed. No communication from any employee or agent of Wolfspeed or any third party shall effect an amendment or modification of this document. No responsibility is assumed by Wolfspeed for any infringement of patents or other rights of third parties which may result from use of the information contained herein. No license is granted by implication or otherwise under any patent or patent rights of Wolfspeed.

Notwithstanding any application-specific information, guidance, assistance, or support that Wolfspeed may provide, the buyer of this product is solely responsible for determining the suitability of this product for the buyer's purposes, including without limitation for use in the applications identified in the next bullet point, and for the compliance of the buyers' products, including those that incorporate this product, with all applicable legal, regulatory, and safety-related requirements.

This product has not been designed or tested for use in, and is not intended for use in, applications in which failure of the product would reasonably be expected to cause death, personal injury, or property damage, including but not limited to equipment implanted into the human body, life-support machines, cardiac defibrillators, and similar emergency medical equipment, aircraft navigation, communication, and control systems, aircraft power and propulsion systems, air traffic control systems, and equipment used in the planning, construction, maintenance, or operation of nuclear facilities.

RoHS Compliance

The levels of RoHS restricted materials in this product are below the maximum concentration values (also referred to as the threshold limits) permitted for such substances, or are used in an exempted application, in accordance with EU Directive 2011/65/EC (RoHS2), as implemented January 2, 2013. RoHS Declarations for this product can be obtained from your Wolfspeed representative or from the Product Documentation sections of www.wolfspeed.com.

REACH Compliance

REACH substances of high concern (SVHCs) information is available for this product. Since the European Chemical Agency (ECHA) has published notice of their intent to frequently revise the SVHC listing for the foreseeable future, please contact your Wolfspeed representative to ensure you get the most up-to-date REACH SVHC Declaration. REACH banned substance information (REACH Article 67) is also available upon request.

Contact info:

4600 Silicon Drive
Durham, NC 27703 USA
Tel: +1.919.313.5300
www.wolfspeed.com/power