

# C3M0060065L

Silicon Carbide Power MOSFET

C3M™ MOSFET Technology

N-Channel Enhancement Mode

## Features

- 3rd generation SiC MOSFET technology
- Optimized package with separate driver source pin
- High blocking voltage with low on-resistance
- High-speed switching with low capacitances
- Fast intrinsic diode with low reverse recovery ( $Q_{rr}$ )
- Halogen free, RoHS compliant

## Benefits

- Reduce switching losses and minimize gate ringing
- Higher system efficiency
- Reduce cooling requirements
- Increase power density
- Increase system switching frequency

## Typical Applications

- Datacenter Power Supplies
- Telecom Power Supplies
- Energy Storage Systems
- Solar (PV) inverters
- High Voltage DC/DC converters

## Package

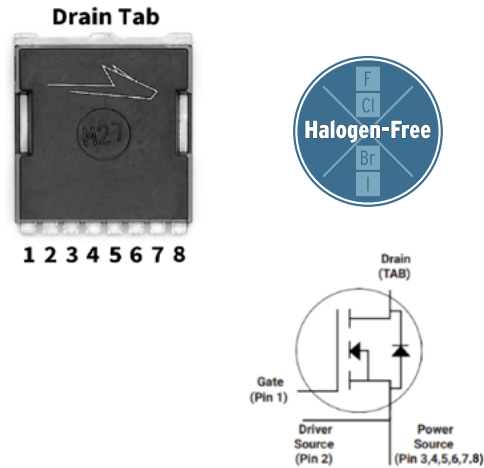

Orderable Part Number	Package	Marking
C3M0060065L-TR	TOLL	C3M0060065L

## Key Parameters

Parameter	Symbol	Min.	Typ.	Max	Unit	Conditions	Note
Drain - Source Voltage	$V_{DS}$			650	v	$T_c = 25^\circ\text{C}$	
Maximum Gate - Source Voltage	$V_{GS(max)}$	-8		+19		Transient	
Operational Gate-Source Voltage	$V_{GSop}$		-4/15			Static	Note 1
DC Continuous Drain Current	$I_D$			39	A	$V_{GS} = 15\text{ V}, T_c = 25^\circ\text{C}, T_J \leq 175^\circ\text{C}$	Fig. 19 Note 2
				25		$V_{GS} = 15\text{ V}, T_c = 100^\circ\text{C}, T_J \leq 175^\circ\text{C}$	
Pulsed Drain Current	$I_{DM}$			99		$t_{Pmax}$ limited by $T_{Jmax}$ $V_{GS} = 15\text{ V}, T_c = 25^\circ\text{C}$	Fig. 22
Power Dissipation	$P_D$			131	W	$T_c = 25^\circ\text{C}, T_J = 175^\circ\text{C}$	Fig. 20
Junction Temperature	$T_J$			-40 to +175	°C		
Case and Storage Temperature	$T_c, T_{stg}$			-40 to +150			
Solder Temperature	$T_L$			260		According to JEDEC J-STD-020	

Note (1): Recommended turn-on gate voltage is 15V with  $\pm 5\%$  regulation tolerance, see Application Note PRD-04814 for additional details

Note (2): Verified by design

**Electrical Characteristics** ( $T_C = 25^\circ\text{C}$  unless otherwise specified)

Symbol	Parameter	Min.	Typ.	Max.	Unit	Test Conditions	Note
$V_{(BR)DSS}$	Drain-Source Breakdown Voltage	650			V	$V_{GS} = 0\text{ V}, I_D = 100\ \mu\text{A}$	
$V_{GS(th)}$	Gate Threshold Voltage	1.8	2.8	3.6	V	$V_{DS} = V_{GS}, I_D = 3.64\ \text{mA}$	Fig. 11
			2.2		V	$V_{DS} = V_{GS}, I_D = 3.64\ \text{mA}, T_J = 175^\circ\text{C}$	
$I_{DSS}$	Zero Gate Voltage Drain Current		1	50	$\mu\text{A}$	$V_{DS} = 650\ \text{V}, V_{GS} = 0\ \text{V}$	
$I_{GSS}$	Gate-Source Leakage Current		10	250	nA	$V_{GS} = 15\ \text{V}, V_{DS} = 0\ \text{V}$	
$R_{DS(on)}$	Drain-Source On-State Resistance		60	79	m $\Omega$	$V_{GS} = 15\ \text{V}, I_D = 13.2\ \text{A}$	Fig. 4, 5, 6
			84			$V_{GS} = 15\ \text{V}, I_D = 13.2\ \text{A}, T_J = 175^\circ\text{C}$	
$g_{fs}$	Transconductance		9		S	$V_{DS} = 20\ \text{V}, I_{DS} = 13.2\ \text{A}$	Fig. 7
			9			$V_{DS} = 20\ \text{V}, I_{DS} = 13.2\ \text{A}, T_J = 175^\circ\text{C}$	
$C_{iss}$	Input Capacitance		1170		pF	$V_{GS} = 0\ \text{V}, V_{DS} = 400\ \text{V}$ $F = 1\ \text{MHz}$ $V_{AC} = 25\ \text{mV}$	Fig. 17, 18
$C_{oss}$	Output Capacitance		72				
$C_{rss}$	Reverse Transfer Capacitance		6				
$E_{oss}$	$C_{oss}$ Stored Energy		14		$\mu\text{J}$	$V_{DS} = 600\ \text{V}, F = 1\ \text{MHz}$	
$C_{o(er)}$	Effective Output Capacitance (Energy Related)		85		pF	$V_{GS} = 0\ \text{V}, V_{DS} = 0 \dots 400\ \text{V}$	Note: 3
$C_{o(tr)}$	Effective Output Capacitance (Time Related)		122				
$E_{oN}$	Turn-On Switching Energy (Body Diode FWD)		28		$\mu\text{J}$	$V_{DS} = 400\ \text{V}, V_{GS} = -4\ \text{V}/15\ \text{V}, I_D = 13.2\ \text{A},$ $R_{G(ext)} = 2.5\ \Omega, L = 135\ \mu\text{H}, T_J = 25^\circ\text{C}$ FWD = Internal Body Diode	Fig. 23
$E_{oFF}$	Turn-Off Switching Energy (Body Diode FWD)		11				
$t_{d(on)}$	Turn-On Delay Time		6		ns	$V_{DD} = 400\ \text{V}, V_{GS} = -4\ \text{V}/15\ \text{V}$ $I_D = 13.2\ \text{A}, R_{G(ext)} = 2.5\ \Omega,$ Timing relative to $V_{DS}$ Inductive load	Fig. 26
$t_r$	Rise Time		8				
$t_{d(off)}$	Turn-Off Delay Time		14				
$t_f$	Fall Time		7				
$R_{G(int)}$	Internal Gate Resistance		4		$\Omega$	$f = 1\ \text{MHz}, V_{AC} = 25\ \text{mV}$	
$Q_{gs}$	Gate to Source Charge		16		nC	$V_{DS} = 400\ \text{V}, V_{GS} = -4\ \text{V}/15\ \text{V}$ $I_D = 13.2\ \text{A}$ Per IEC60747-8-4 pg 21	Fig. 12
$Q_{gd}$	Gate to Drain Charge		12				
$Q_g$	Total Gate Charge		46				

Note (3):  $C_{o(er)}$ , a lumped capacitance that gives same stored energy as  $C_{oss}$  while  $V_{ds}$  is rising from 0 to 400V  
 $C_{o(tr)}$ , a lumped capacitance that gives same charging time as  $C_{oss}$  while  $V_{ds}$  is rising from 0 to 400V



### Reverse Diode Characteristics ( $T_c = 25^\circ\text{C}$ unless otherwise specified)

Symbol	Parameter	Typ.	Max.	Unit	Test Conditions	Note
$V_{SD}$	Diode Forward Voltage	4.6		V	$V_{GS} = -4\text{ V}, I_{SD} = 6.6\text{ A}, T_J = 25^\circ\text{C}$	Fig. 8, 9, 10
		4.1		V	$V_{GS} = -4\text{ V}, I_{SD} = 6.6\text{ A}, T_J = 175^\circ\text{C}$	
$I_S$	Continuous Diode Forward Current		22	A	$V_{GS} = -4\text{ V}, T_c = 25^\circ\text{C}$	
$I_{S, pulse}$	Diode pulse Current		99	A	$V_{GS} = -4\text{ V}$ , pulse width $t_p$ limited by $T_{Jmax}$	
$t_{rr}$	Reverse Recover time	9		ns	$V_{GS} = -4\text{ V}, I_{SD} = 13.2\text{ A}, V_R = 400\text{ V}$ $dif/dt = 5570\text{ A}/\mu\text{s}, T_J = 25^\circ\text{C}$	
$Q_{rr}$	Reverse Recovery Charge	142		nC		
$I_{rrm}$	Peak Reverse Recovery Current	33		A		
$t_{rr}$	Reverse Recover time	10		ns	$V_{GS} = -4\text{ V}, I_{SD} = 13.2\text{ A}, V_R = 400\text{ V}$ $dif/dt = 2160\text{ A}/\mu\text{s}, T_J = 25^\circ\text{C}$	
$Q_{rr}$	Reverse Recovery Charge	60		nC		
$I_{rrm}$	Peak Reverse Recovery Current	10		A		

### Thermal Characteristics

Symbol	Parameter	Typ.	Unit	Test Conditions	Note
$R_{\theta JC}$	Thermal Resistance from Junction to Case	0.89	$^\circ\text{C}/\text{W}$		Fig. 21



Typical Performance

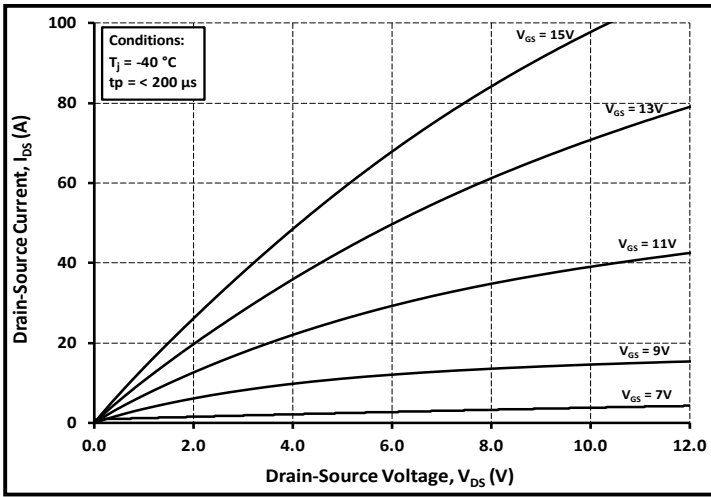

Figure 1. Output Characteristics  $T_J = -40\text{ }^\circ\text{C}$

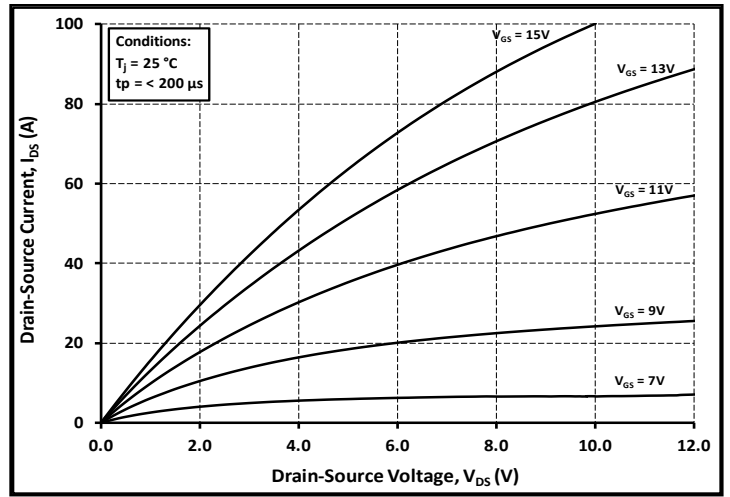

Figure 2. Output Characteristics  $T_J = 25\text{ }^\circ\text{C}$

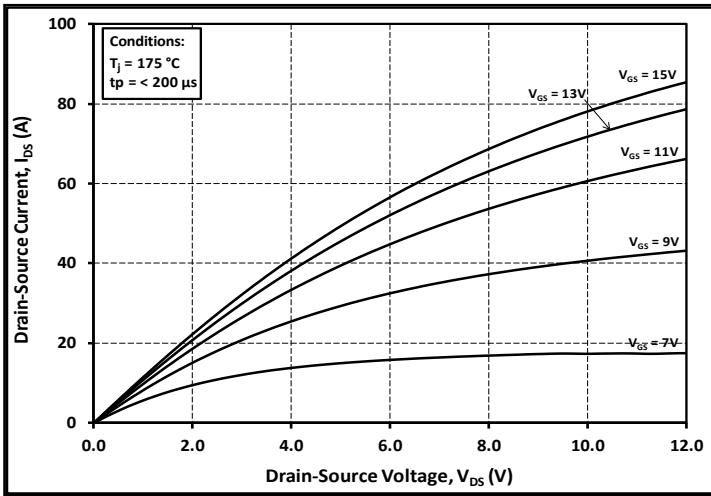

Figure 3. Output Characteristics  $T_J = 175\text{ }^\circ\text{C}$

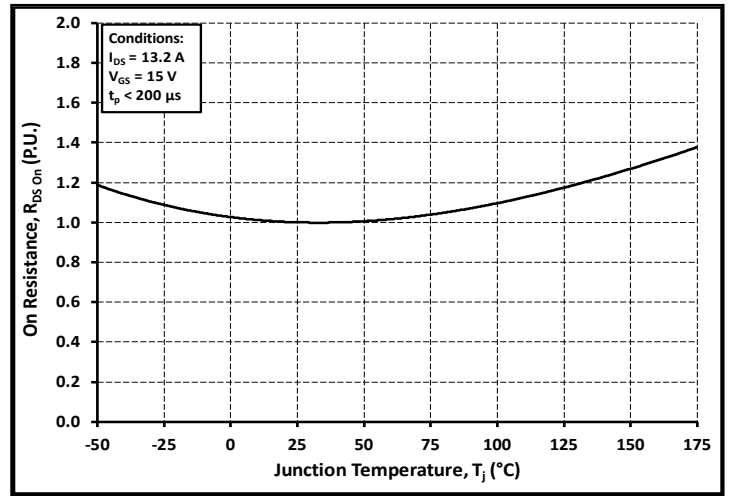

Figure 4. Normalized On-Resistance vs. Temperature

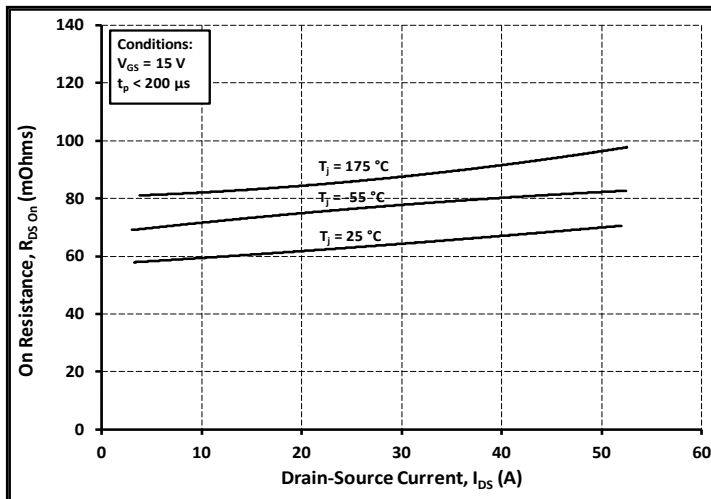

Figure 5. On-Resistance vs. Drain Current For Various Temperatures

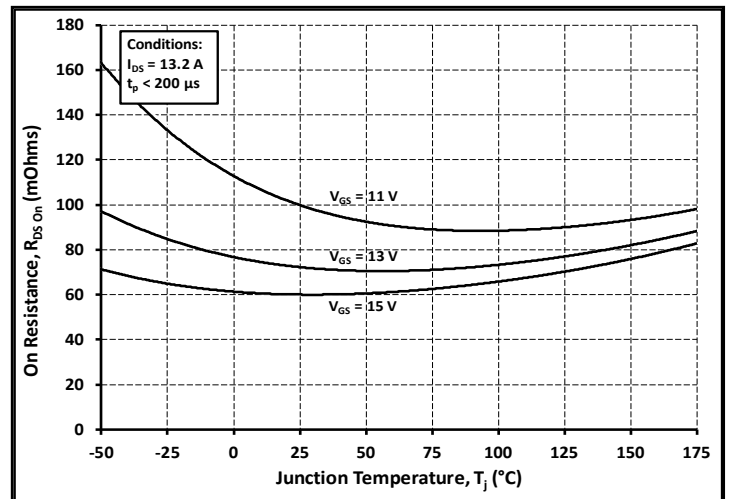

Figure 6. On-Resistance vs. Temperature For Various Gate Voltage



Typical Performance

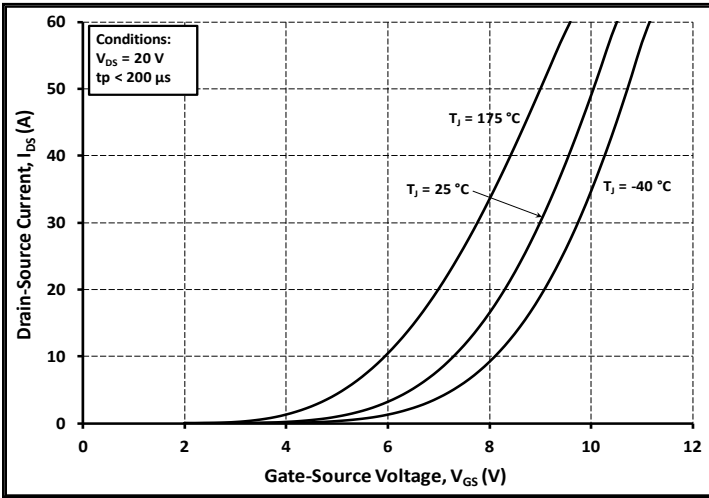

Figure 7. Transfer Characteristic for Various Junction Temperatures

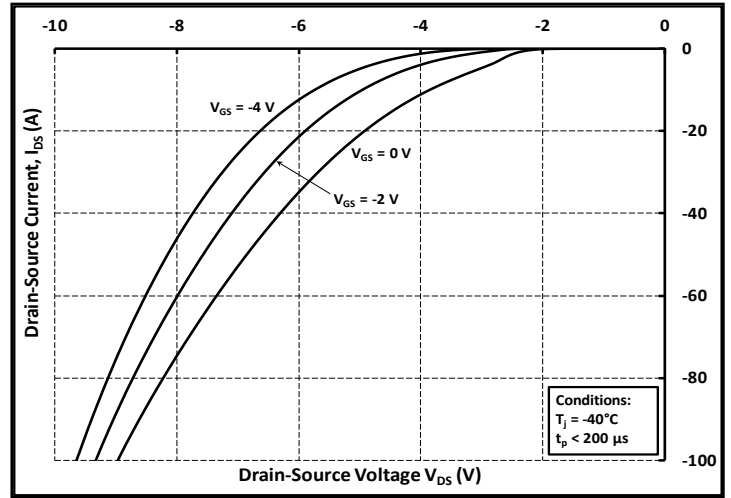

Figure 8. Body Diode Characteristic at -40 °C

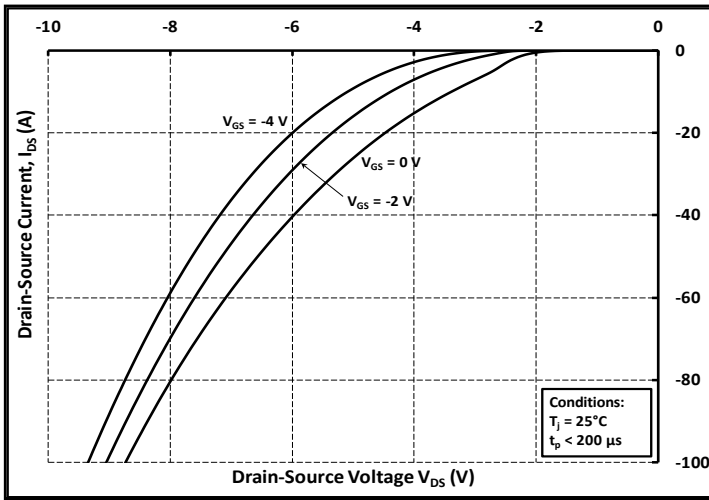

Figure 9. Body Diode Characteristic at 25 °C

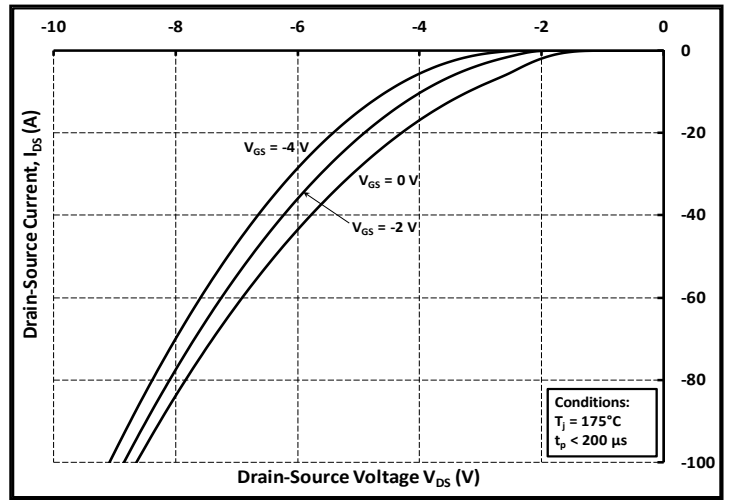

Figure 10. Body Diode Characteristic at 175 °C

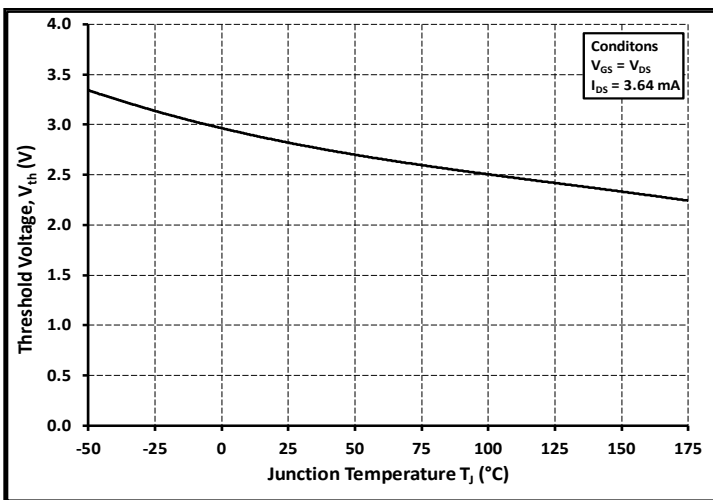

Figure 11. Threshold Voltage vs. Temperature

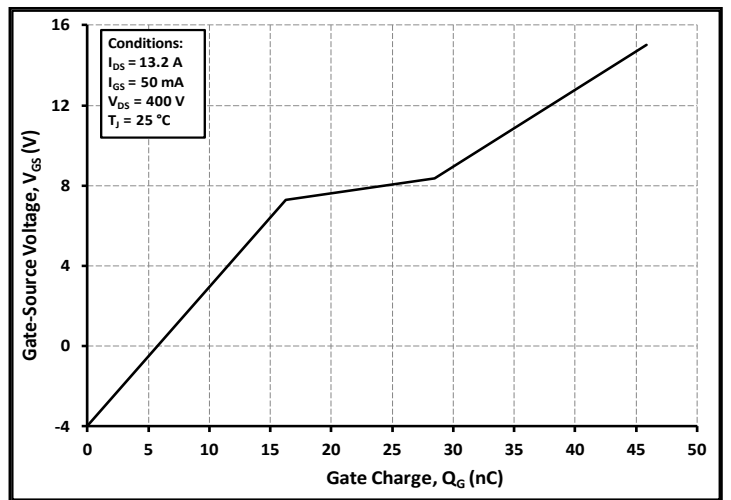

Figure 12. Gate Charge Characteristics



Typical Performance

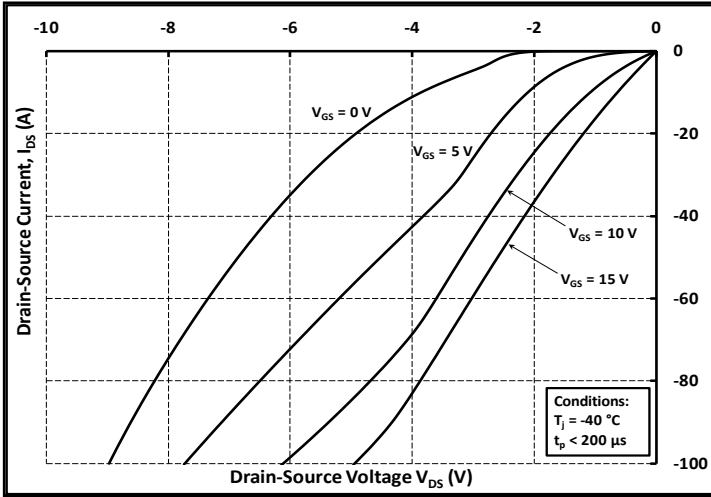

Figure 13. 3rd Quadrant Characteristic at -40 °C

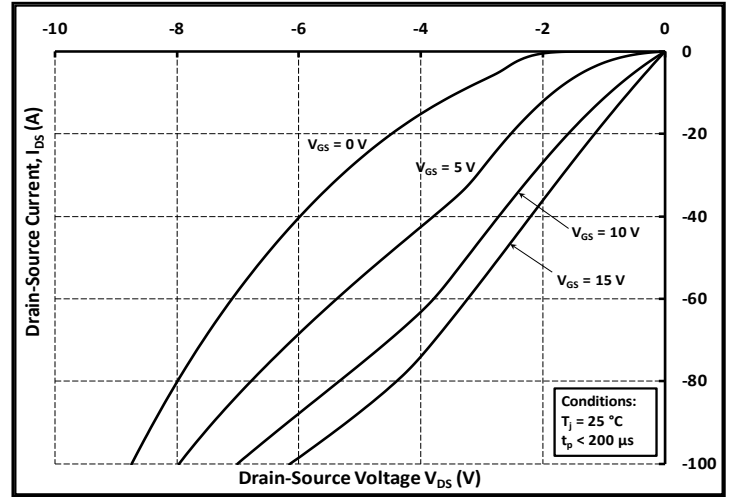

Figure 14. 3rd Quadrant Characteristic at 25 °C

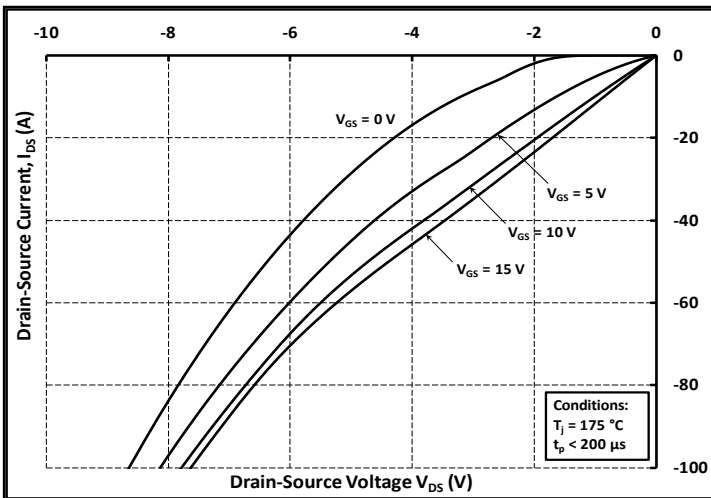

Figure 15. 3rd Quadrant Characteristic at 175 °C

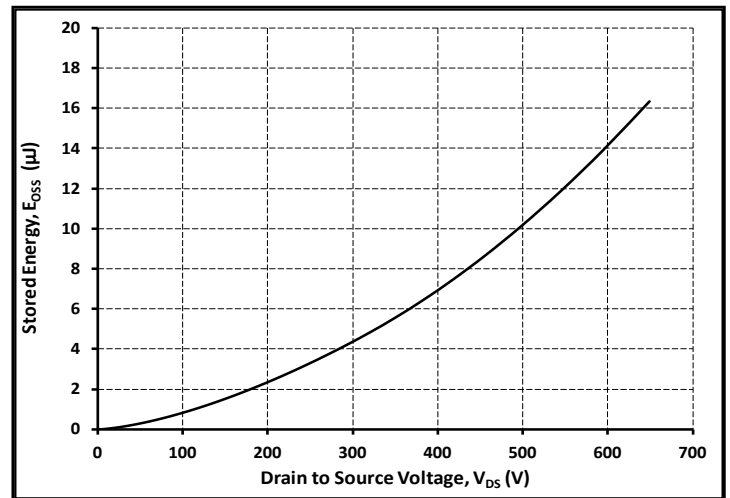

Figure 16. Output Capacitor Stored Energy

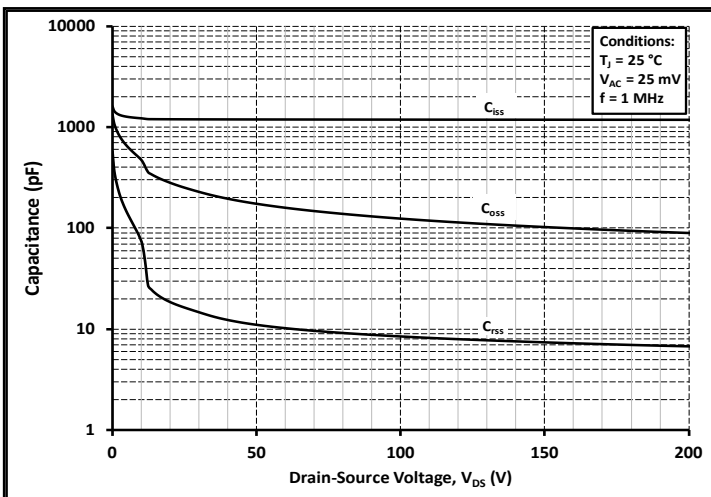

Figure 17. Capacitances vs. Drain-Source Voltage (0 - 200V)

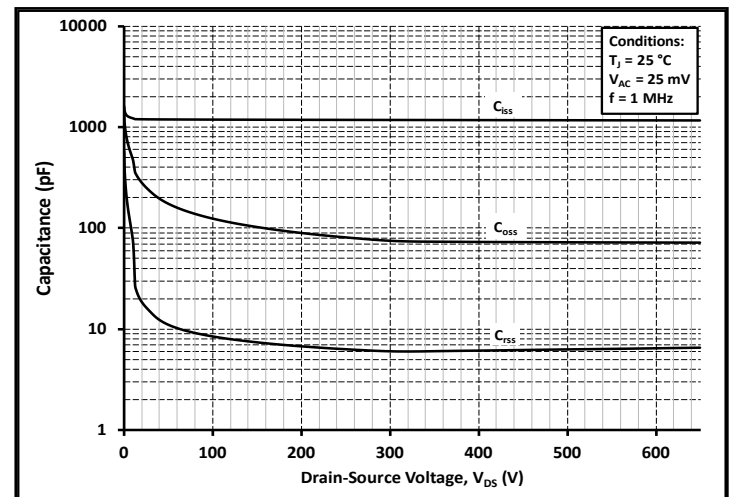

Figure 18. Capacitances vs. Drain-Source Voltage (0 - 650V)



Typical Performance

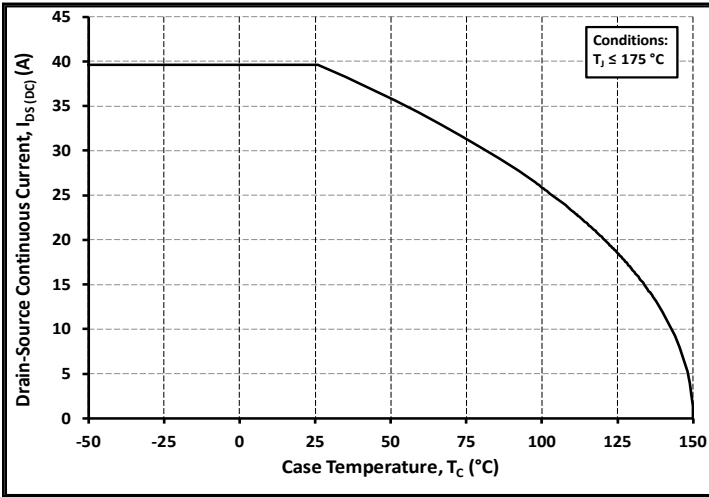

Figure 19. Continuous Drain Current Derating vs. Case Temperature

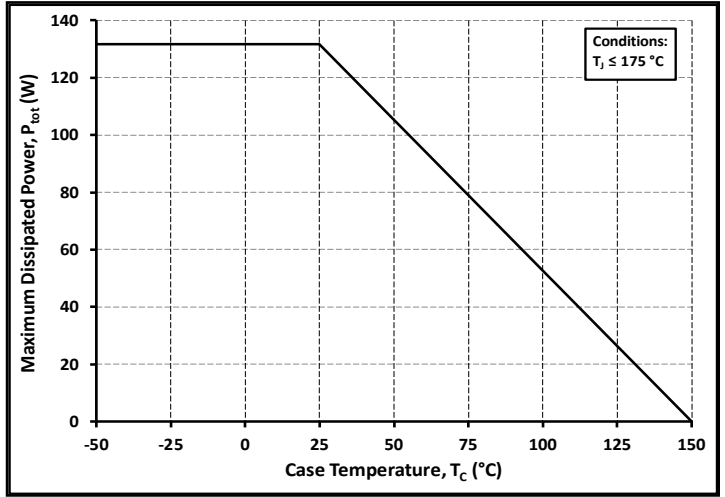

Figure 20. Maximum Power Dissipation Derating vs. Case Temperature

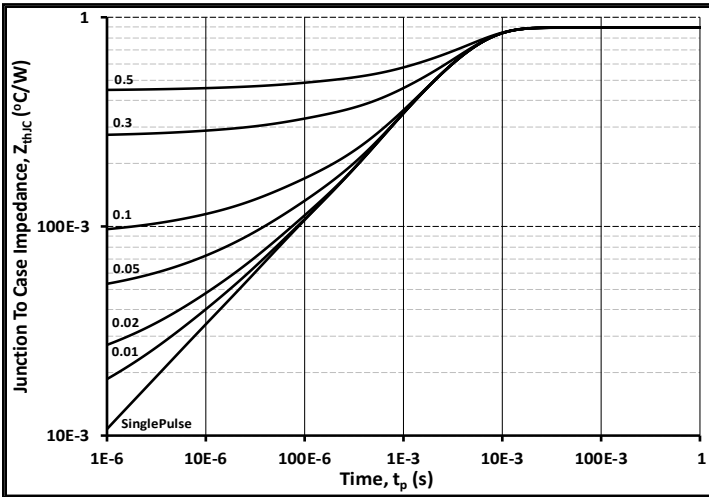

Figure 21. Transient Thermal Impedance (Junction - Case)

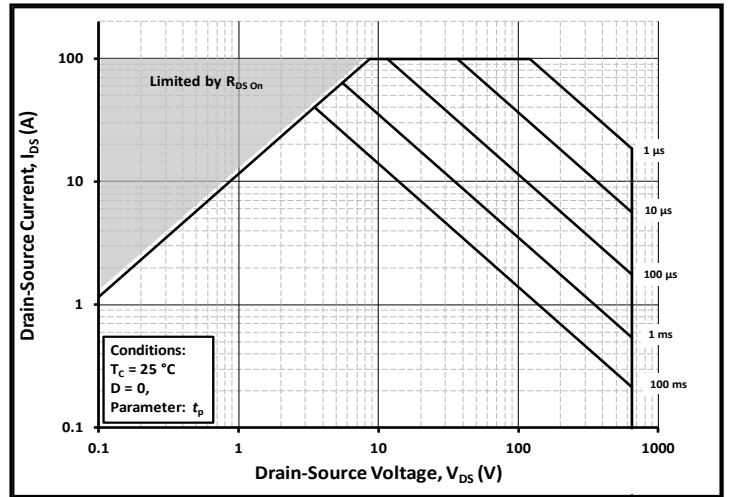

Figure 22. Safe Operating Area

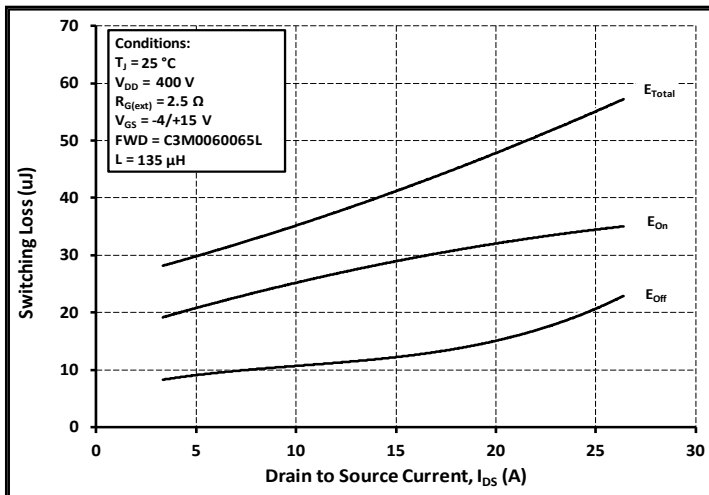

Figure 23. Clamped Inductive Switching Energy vs. Drain Current ( $V_{DD} = 400V$ )

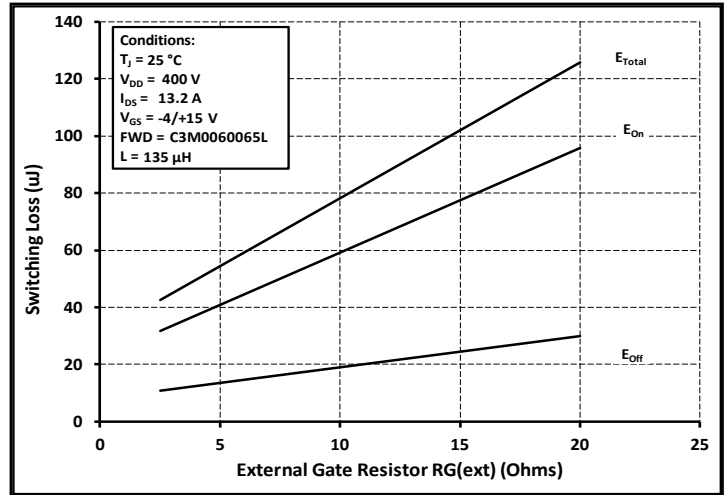

Figure 24. Clamped Inductive Switching Energy vs.  $R_{G(ext)}$

Typical Performance

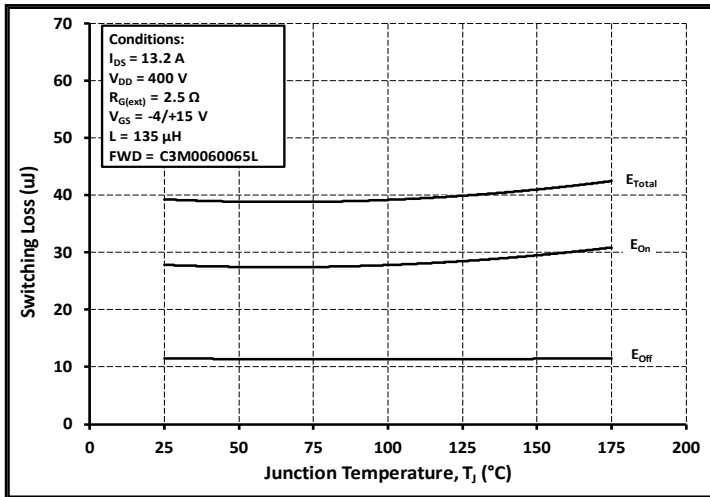

Figure 25. Clamped Inductive Switching Energy vs. Temperature

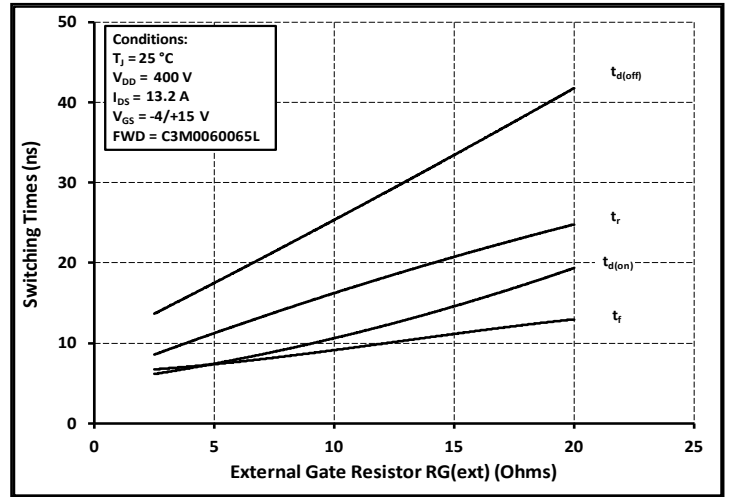

Figure 26. Switching Times vs.  $R_{G(ext)}$

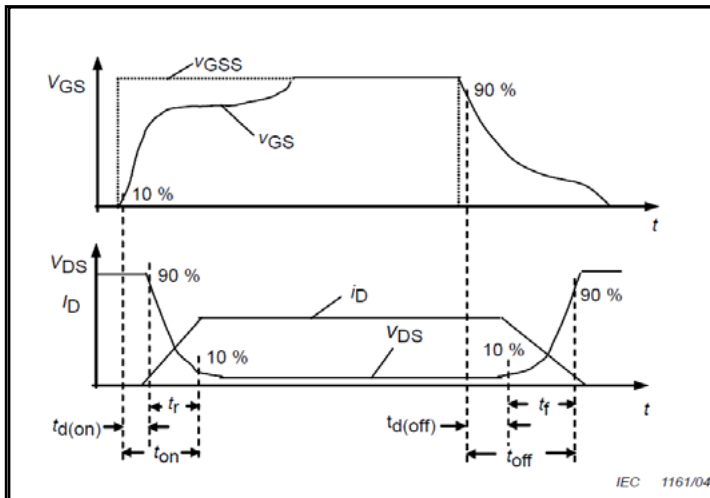

Figure 27. Switching Times Definition



## Test Circuit Schematic

---

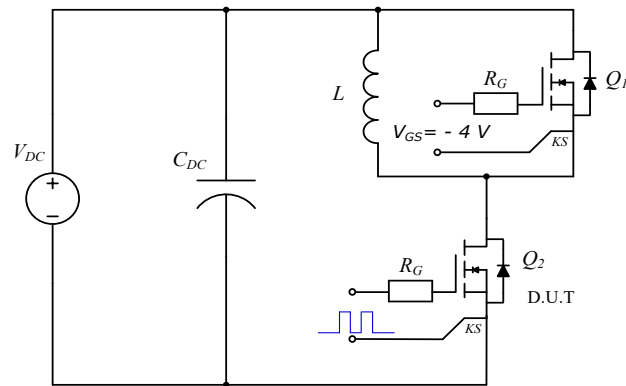
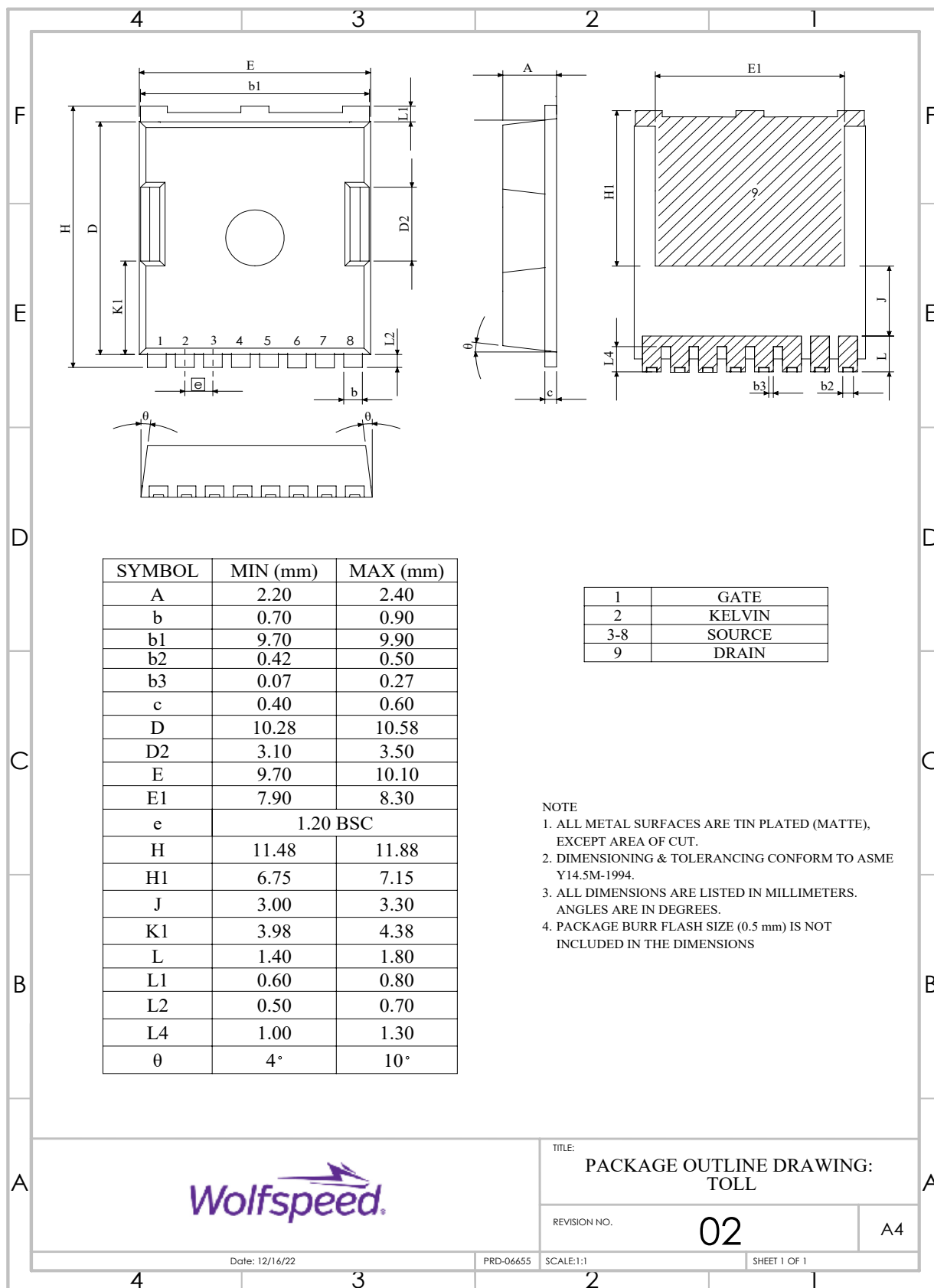

Figure 28. Clamped Inductive Switching Waveform Test Circuit

**Package Dimensions**





## Recommended Solder Pad Layout

(Note: All Dimensions are listed in Millimeters)

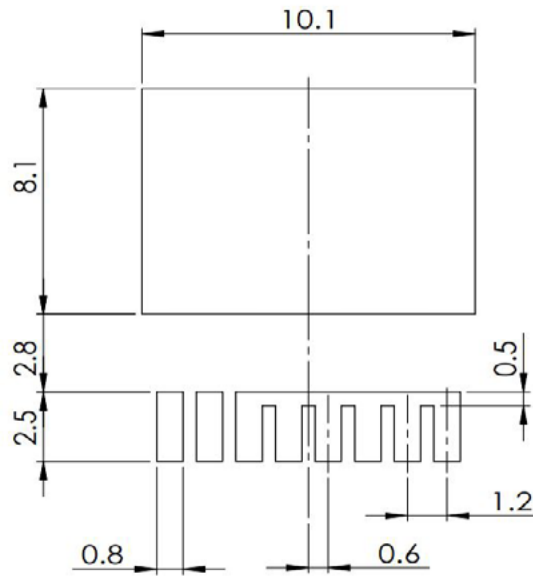



## Revision history

---

Document Version	Date of release	Description of changes
1.0	September-2022	Initial datasheet
2.0	November-2022	Correction in the placement of "E1" package dimension Orderable part number information added
3	December - 2024	Legal Disclaimer, Table 1 layout revised



## Notes & Disclaimer

---

WOLFSPEED PROVIDES TECHNICAL AND RELIABILITY DATA, DESIGN RESOURCES, APPLICATION OR OTHER DESIGN ADVICE, WEB TOOLS, AND OTHER RESOURCES “AS IS” AND WITH ALL FAULTS, AND DISCLAIMS ALL WARRANTIES, EXPRESS AND IMPLIED, WITH RESPECT THERETO, INCLUDING WITHOUT LIMITATION ANY IMPLIED WARRANTIES OF MERCHANTABILITY, SUITABILITY, FITNESS FOR A PARTICULAR PURPOSE, OR NON-INFRINGEMENT OF THIRD-PARTY INTELLECTUAL PROPERTY RIGHTS.

This document and the information contained herein are subject to change without notice. Any such change shall be evidenced by the publication of an updated version of this document by Wolfspeed. No communication from any employee or agent of Wolfspeed or any third party shall effect an amendment or modification of this document. No responsibility is assumed by Wolfspeed for any infringement of patents or other rights of third parties which may result from use of the information contained herein. No license is granted by implication or otherwise under any patent or patent rights of Wolfspeed.

The information contained in this document (excluding examples, as well as figures or values that are labeled as “typical”) constitutes Wolfspeed’s sole published specifications for the subject product. “Typical” parameters are the average values expected by Wolfspeed in large quantities and are provided for informational purposes only. Any examples provided herein have not been produced under conditions intended to replicate any specific end use. Product performance can and does vary due to a number of factors.

This product has not been designed or tested for use in, and is not intended for use in, any application in which failure of the product would reasonably be expected to cause death, personal injury, or property damage. For purposes of (but without limiting) the foregoing, this product is not designed, intended, or authorized for use as a critical component in equipment implanted into the human body, life-support machines, cardiac defibrillators, and similar emergency medical equipment; air traffic control systems; or equipment used in the planning, construction, maintenance, or operation of nuclear facilities. Notwithstanding any application-specific information, guidance, assistance, or support that Wolfspeed may provide, the buyer of this product is solely responsible for determining the suitability of this product for the buyer’s purposes, including without limitation (1) selecting the appropriate Wolfspeed products for the buyer’s application, (2) designing, validating, and testing the buyer’s application, and (3) ensuring the buyer’s application meets applicable standards and any other legal, regulatory, and safety-related requirements.

### **RoHS Compliance**

The levels of RoHS restricted materials in this product are below the maximum concentration values (also referred to as the threshold limits) permitted for such substances, or are used in an exempted application, in accordance with EU Directive 2011/65/EC (RoHS2), as implemented January 2, 2013. RoHS Declarations for this product can be obtained from your Wolfspeed representative or from the Product Documentation sections of [www.wolfspeed.com](http://www.wolfspeed.com).

### **REACH Compliance**

REACH substances of high concern (SVHCs) information is available for this product. Since the European Chemical Agency (ECHA) has published notice of their intent to frequently revise the SVHC listing for the foreseeable future, please contact your Wolfspeed representative to ensure you get the most up-to-date REACH SVHC Declaration. REACH banned substance information (REACH Article 67) is also available upon request. SVHC Declaration. REACH banned substance information (REACH Article 67) is also available upon request.

### **Contact info:**

4600 Silicon Drive  
Durham, NC 27703 USA  
Tel: +1.919.313.5300  
[www.wolfspeed.com/power](http://www.wolfspeed.com/power)

© 2024 Wolfspeed, Inc. All rights reserved. Wolfspeed® and the Wolfstreak logo are registered trademarks and the Wolfspeed logo is a trademark of Wolfspeed, Inc.  
PATENT: <https://www.wolfspeed.com/legal/patents>

The information in this document is subject to change without notice.