

# C3M0120065J

Silicon Carbide Power MOSFET C3M™ MOSFET Technology  
N-Channel Enhancement Mode

## Features

- 3<sup>rd</sup> Generation SiC MOSFET technology
- Low inductance package with driver source pin
- 7mm of creepage distance between drain and source
- High blocking voltage with low on-resistance
- High speed switching with low capacitances
- Fast intrinsic diode with low reverse recovery ( $Q_{rr}$ )
- Halogen free, RoHS compliant

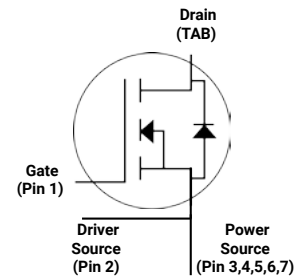

Wolfspeed, Inc. is in the process of rebranding its products and related materials pursuant to the entity name change from Cree, Inc. to Wolfspeed, Inc. During this transition period, products received may be marked with either the Cree name and/or logo or the Wolfspeed name and/or logo.

Ordering Part Number	Package	Marking
C3M0120065J	TO-263-7	C3M0120065J

## Applications

- Solar inverters
- DC/DC converters
- Switch Mode Power Supplies
- EV battery chargers
- UPS

## Benefits

- Higher system efficiency
- Reduced cooling requirements
- Increased power density
- Increased system switching frequency
- Easy to parallel and simple to drive
- Enable new hard switching PFC topologies (Totem-Pole)

## Key Parameters

Parameter	Symbol	Min.	Typ.	Max	Unit	Conditions	Note
Drain - Source Voltage	$V_{DS}$			650	v	$T_C = 25^\circ\text{C}$	
Maximum Gate - Source Voltage	$V_{GS(max)}$	-8		+19		Transient	
Operational Gate-Source Voltage	$V_{GS op}$		-4/15			Static	Note 1
DC Continuous Drain Current	$I_D$			21	A	$V_{GS} = 15\text{ V}, T_C = 25^\circ\text{C}, T_J \leq 175^\circ\text{C}$	Fig. 19
				15		$V_{GS} = 15\text{ V}, T_C = 100^\circ\text{C}, T_J \leq 175^\circ\text{C}$	Note 2
Pulsed Drain Current	$I_{DM}$			51		$t_{Pmax}$ limited by $T_{Jmax}$ $V_{GS} = 15\text{ V}, T_C = 25^\circ\text{C}$	Fig. 22
Power Dissipation	$P_D$			86	W	$T_C = 25^\circ\text{C}, T_J = 175^\circ\text{C}$	Fig. 20
Operating Junction and Storage Temperature	$T_J, T_{stg}$			-40 to +175	°C		
Solder Temperature	$T_L$			260		According to JEDEC J-STD-020	

Note (1): Recommended turn-on gate voltage is 15V with  $\pm 5\%$  regulation tolerance, see Application Note PRD-04814 for additional details

Note (2): Verified by design



## Electrical Characteristics ( $T_C = 25^\circ\text{C}$ unless otherwise specified)

Parameter	Symbol	Min.	Typ.	Max.	Unit	Test Conditions	Note
Drain-Source Breakdown Voltage	$V_{(BR)DSS}$	650	—	—	V	$V_{GS} = 0\text{ V}, I_D = 100\ \mu\text{A}$	Fig. 11
Gate Threshold Voltage	$V_{GS(th)}$	1.8	2.3	3.6		$V_{DS} = V_{GS}, I_D = 1.86\ \text{mA}$	
		—	1.9	—		$V_{DS} = V_{GS}, I_D = 1.86\ \text{mA}, T_J = 175^\circ\text{C}$	
Zero Gate Voltage Drain Current	$I_{DSS}$	—	1	50	$\mu\text{A}$	$V_{DS} = 650\ \text{V}, V_{GS} = 0\ \text{V}$	
Gate-Source Leakage Current	$I_{GSS}$	—	10	250	nA	$V_{GS} = 15\ \text{V}, V_{DS} = 0\ \text{V}$	
Drain-Source On-State Resistance	$R_{DS(on)}$	—	120	157	m $\Omega$	$V_{GS} = 15\ \text{V}, I_D = 6.76\ \text{A}$	Fig. 4, 5, 6
		—	168	—		$V_{GS} = 15\ \text{V}, I_D = 6.76\ \text{A}, T_J = 175^\circ\text{C}$	
Transconductance	$g_{fs}$	—	5.0	—	S	$V_{DS} = 20\ \text{V}, I_{DS} = 6.76\ \text{A}$	Fig. 7
		—	4.9	—		$V_{DS} = 20\ \text{V}, I_{DS} = 6.76\ \text{A}, T_J = 175^\circ\text{C}$	
Input Capacitance	$C_{iss}$	—	640	—	pF	$V_{GS} = 0\ \text{V}, V_{DS} = 0\ \text{V to } 400\ \text{V}$ $f = 1\ \text{Mhz}$ $V_{AC} = 25\ \text{mV}$	Fig. 17, 18
Output Capacitance	$C_{oss}$	—	45	—			
Reverse Transfer Capacitance	$C_{rss}$	—	2.3	—			
Effective Output Capacitance (Energy Related)	$C_{o(er)}$	—	57	—			
Effective Output Capacitance (Time Related)	$C_{o(tr)}$	—	79	—			
$C_{oss}$ Stored Energy	$E_{oss}$	—	4.3	—	$\mu\text{J}$	$V_{DS} = 400\ \text{V}, f = 1\ \text{Mhz}$	Fig. 16
Turn-On Switching Energy (Body Diode)	$E_{on}$	—	28	—		$V_{DS} = 400\ \text{V}, V_{GS} = -4\ \text{V}/15\ \text{V}, I_D = 6.76\ \text{A},$ $R_{G(ext)} = 10\ \Omega, L = 237\ \mu\text{H}, T_J = 175^\circ\text{C}$ FWD = Internal Body Diode of MOSFET	Fig. 25
Turn Off Switching Energy (Body Diode)	$E_{off}$	—	6	—			
Turn-On Delay Time	$t_{d(on)}$	—	8	—	ns	$V_{DD} = 400\ \text{V}, V_{GS} = -4\ \text{V}/15\ \text{V}$ $I_D = 6.76\ \text{A}, R_{G(ext)} = 10\ \Omega$ Timing relative to $V_{DS}$ Inductive load	Fig. 26
Rise Time	$t_r$	—	9	—			
Turn-Off Delay Time	$t_{d(off)}$	—	18	—			
Fall Time	$t_f$	—	9	—			
Internal Gate Resistance	$R_{G(int)}$	—	6	—	$\Omega$	$f = 1\ \text{MHz}, V_{AC} = 25\ \text{mV}$	
Gate to Source Charge	$Q_{gs}$	—	8	—	nC	$V_{DS} = 400\ \text{V}, V_{GS} = -4\ \text{V}/15\ \text{V}$ $I_D = 6.76\ \text{A}$ Per IEC60747-8-4 pg 21	Fig. 12
Gate to Drain Charge	$Q_{gd}$	—	7	—			
Total Gate Charge	$Q_g$	—	26	—			

### Note:

<sup>3</sup>  $C_{o(er)}$ , a lumped capacitance that gives same stored energy as  $C_{oss}$  while  $V_{DS}$  is rising from 0 to 400V

$C_{o(tr)}$ , a lumped capacitance that gives same charging time as  $C_{oss}$  while  $V_{DS}$  is rising from 0 to 400V



## Reverse Diode Characteristics ( $T_c = 25^\circ\text{C}$ unless otherwise specified)

Parameter	Symbol	Typ.	Max.	Unit	Test Conditions	Notes
Diode Forward Voltage	$V_{SD}$	4.5	—	V	$V_{GS} = -4\text{ V}, I_{SD} = 3.4\text{ A}, T_J = 25^\circ\text{C}$	Fig. 8, 9, 10
		4.0	—		$V_{GS} = -4\text{ V}, I_{SD} = 3.4\text{ A}, T_J = 175^\circ\text{C}$	
Continuous Diode Forward Current	$I_S$	—	15	A	$V_{GS} = -4\text{ V}, T_c = 25^\circ\text{C}$	
Diode pulse Current	$I_{S, pulse}$	—	51		$V_{GS} = -4\text{ V}$ , pulse width $t_p$ limited by $T_{jmax}$	
Reverse Recovery Time	$t_{rr}$	8	—	ns	$V_{GS} = -4\text{ V}, I_{SD} = 6.76\text{ A}, V_R = 400\text{ V}$ $di_f/dt = 5470\text{ A}/\mu\text{s}, T_J = 175^\circ\text{C}$	
Reverse Recovery Charge	$Q_{rr}$	78	—	nC		
Peak Reverse Recovery Current	$I_{RRM}$	16	—	A		
Reverse Recovery Time	$t_{rr}$	9	—	ns	$V_{GS} = -4\text{ V}, I_{SD} = 6.76\text{ A}, V_R = 400\text{ V}$ $di_f/dt = 3650\text{ A}/\mu\text{s}, T_J = 175^\circ\text{C}$	
Reverse Recovery Charge	$Q_{rr}$	41	—	nC		
Peak Reverse Recovery Current	$I_{RRM}$	7	—	A		

## Thermal Characteristics

Parameter	Symbol	Typ.	Unit	Note
Thermal Resistance from Junction to Case	$R_{\theta JC}$	1.73	$^\circ\text{C}/\text{W}$	Fig. 21
Thermal Resistance From Junction to Ambient	$R_{\theta JA}$	40		



Typical Performance

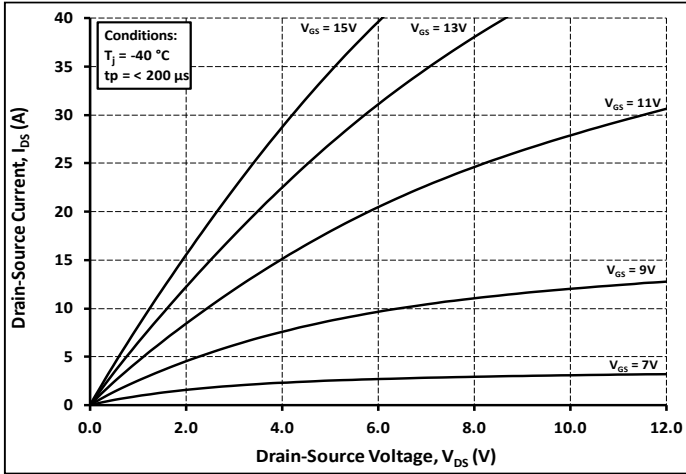

Figure 1. Output Characteristics  $T_j = -40^\circ\text{C}$

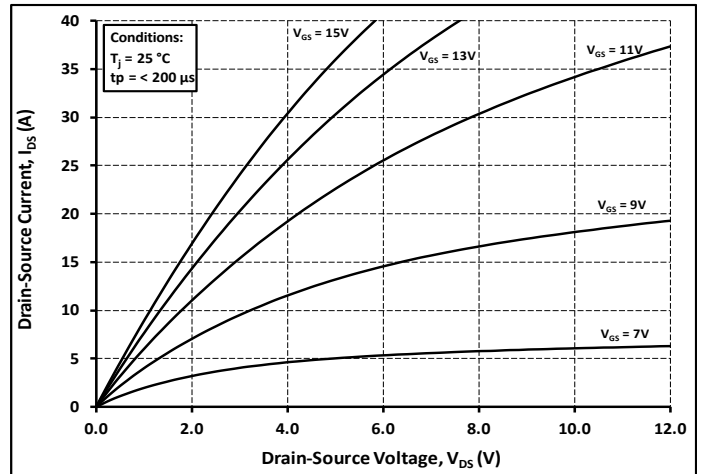

Figure 2. Output Characteristics  $T_j = 25^\circ\text{C}$

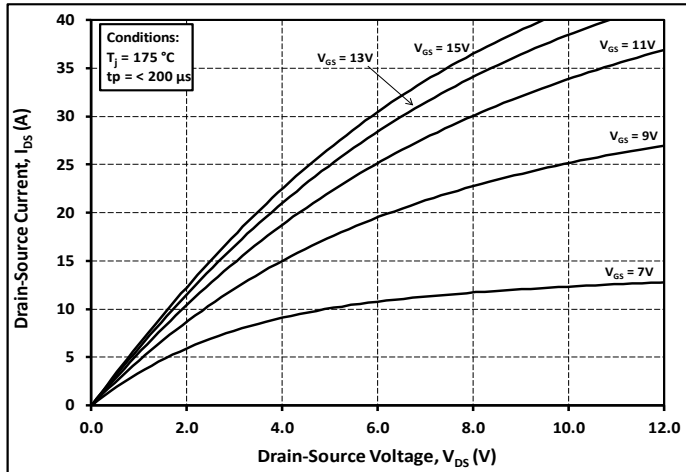

Figure 3. Output Characteristics  $T_j = 175^\circ\text{C}$

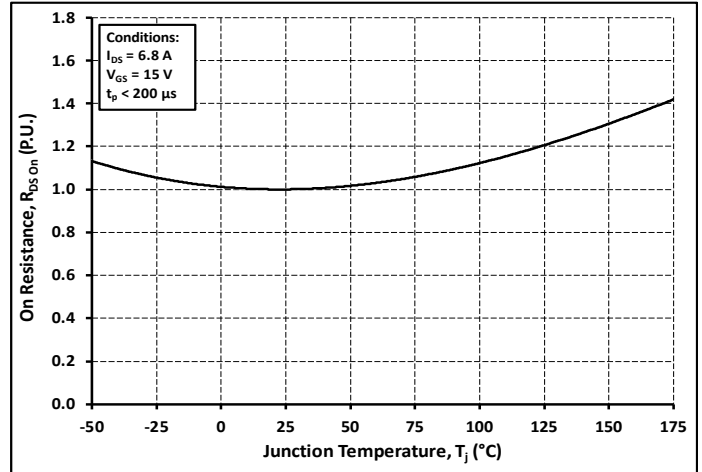

Figure 4. Normalized On-Resistance vs. Temperature

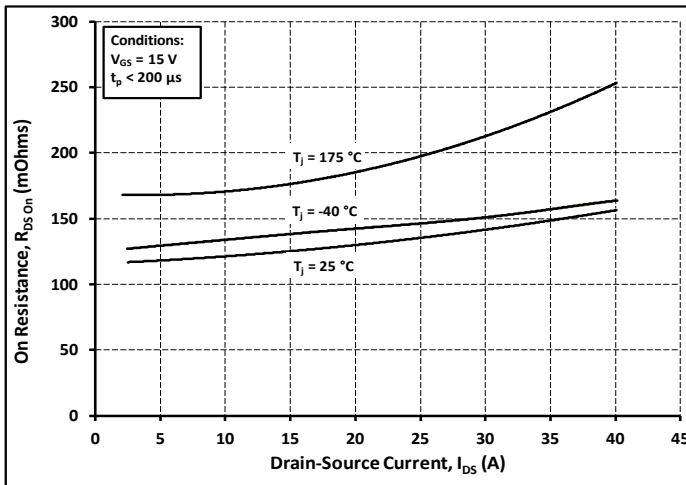

Figure 5. On-Resistance vs. Drain Current For Various Temperatures

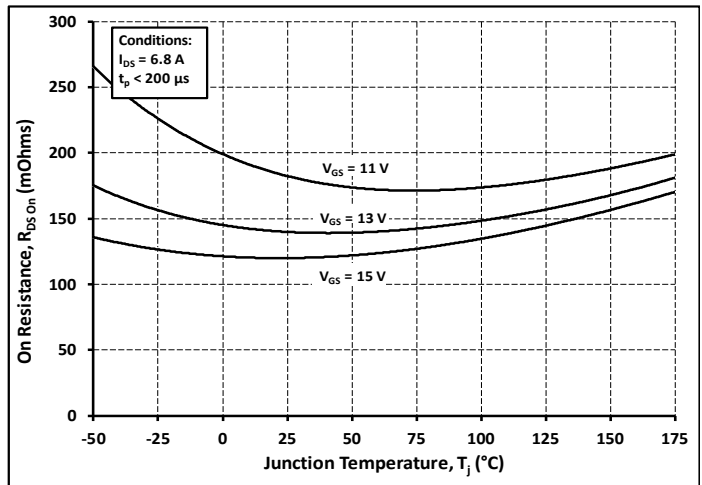

Figure 6. On-Resistance vs. Temperature For Various Gate Voltage



Typical Performance

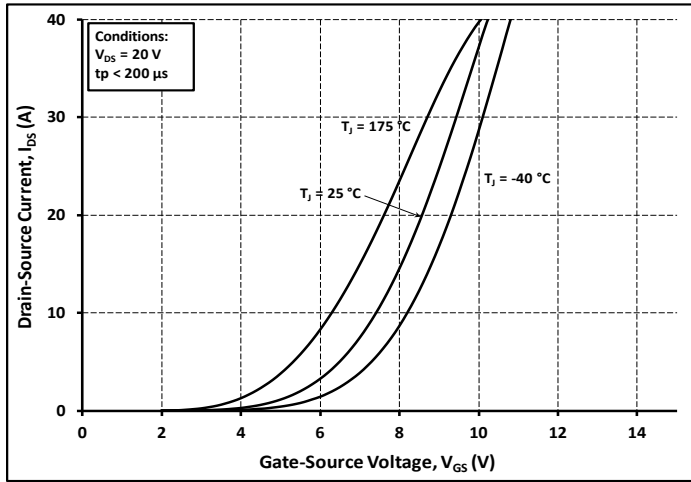

Figure 7. Transfer Characteristic for Various Junction Temperatures

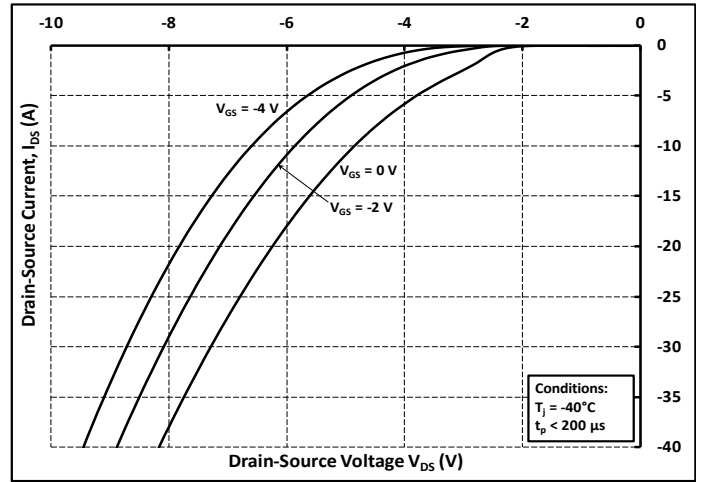

Figure 8. Body Diode Characteristic at -40°C

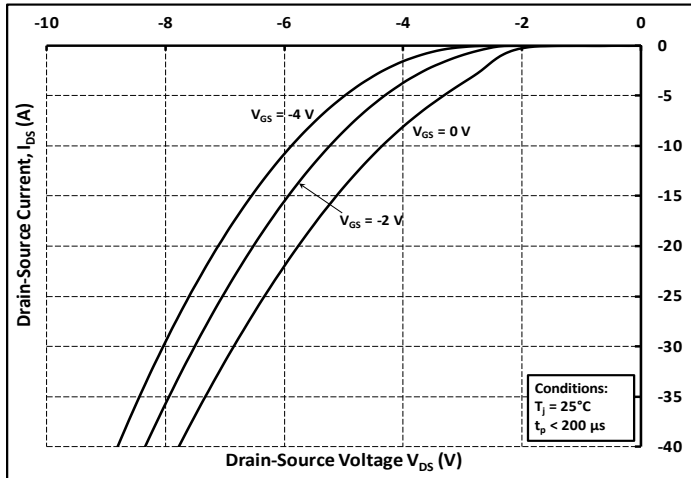

Figure 9. Body Diode Characteristic at 25°C

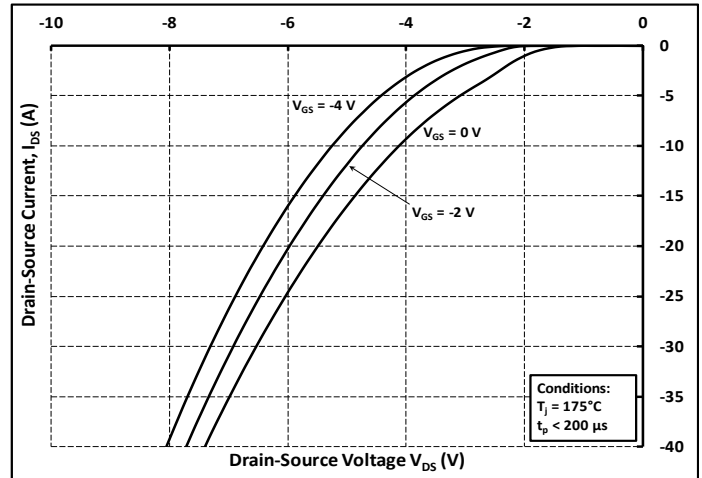

Figure 10. Body Diode Characteristic at 175°C

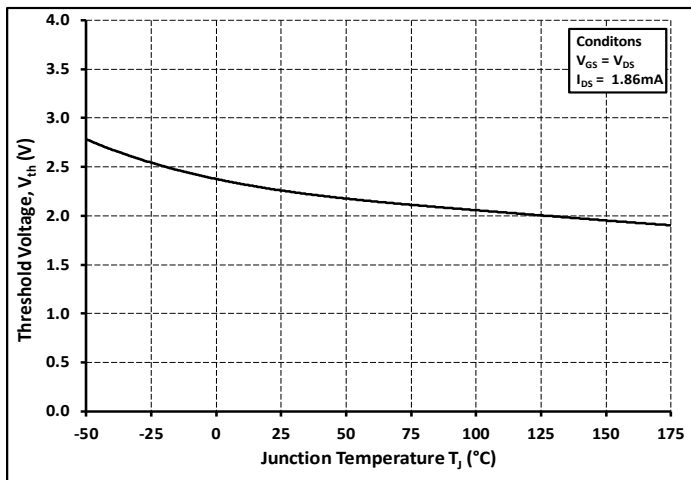

Figure 11. Threshold Voltage vs. Temperature

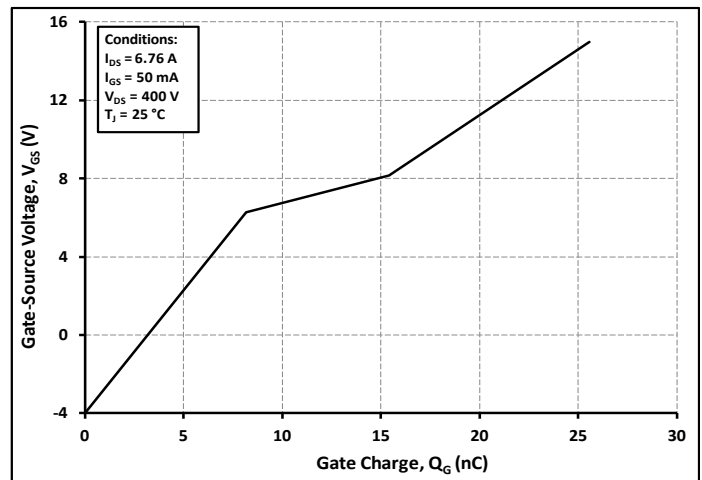

Figure 12. Gate Charge Characteristics



Typical Performance

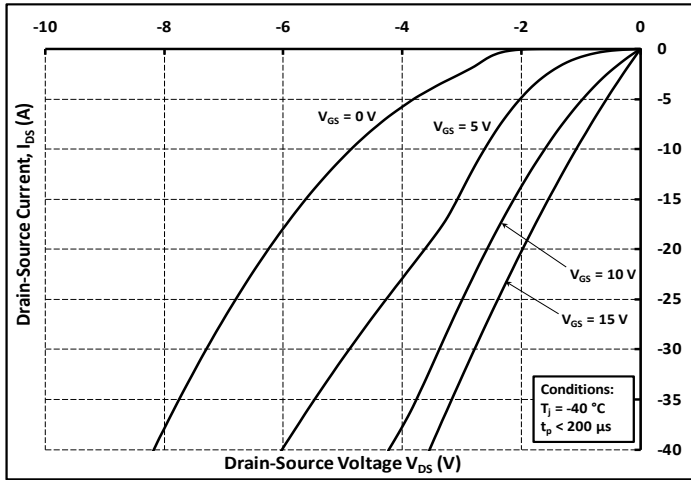

Figure 13. 3rd Quadrant Characteristic at -40°C

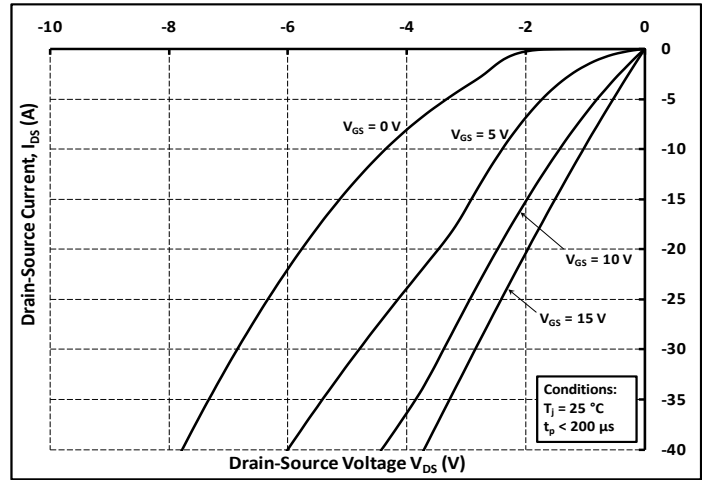

Figure 14. 3rd Quadrant Characteristic at 25°C

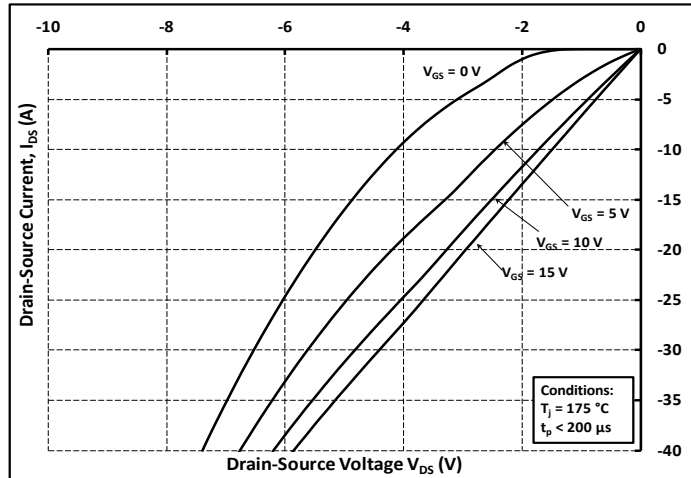

Figure 15. 3rd Quadrant Characteristic at 175°C

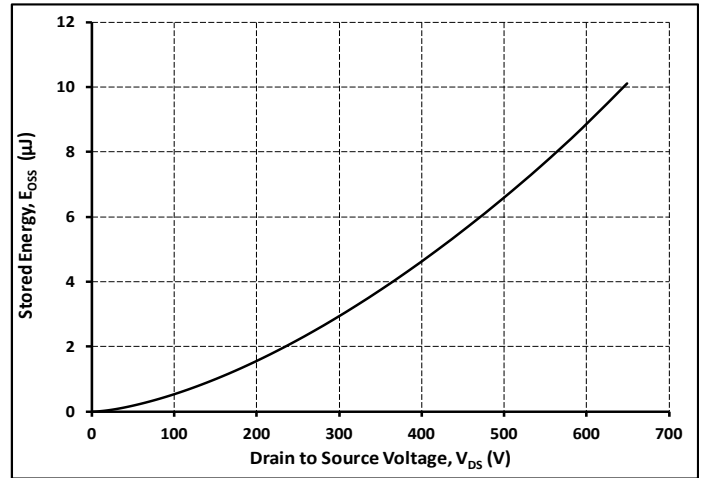

Figure 16. Output Capacitor Stored Energy

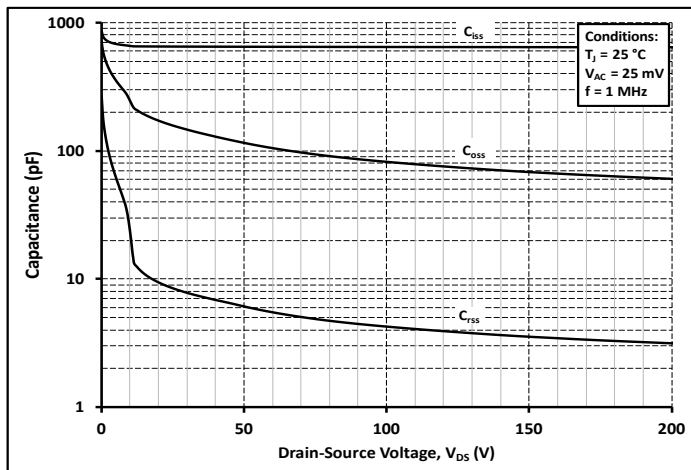

Figure 17. Capacitances vs. Drain-Source Voltage (0 - 200 V)

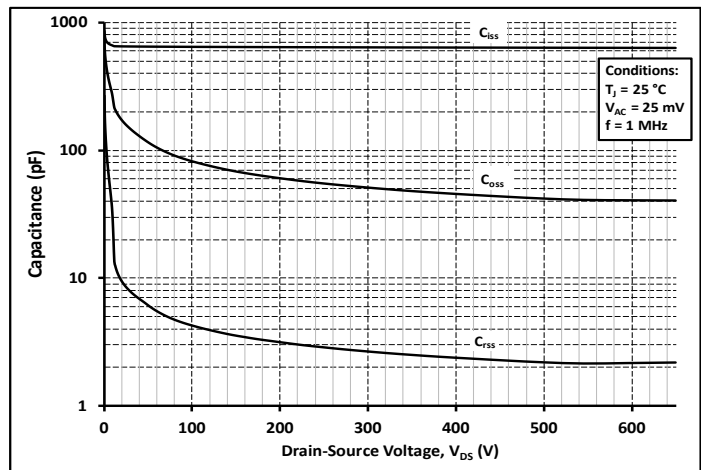

Figure 18. Capacitances vs. Drain-Source Voltage (0 - 650 V)



Typical Performance

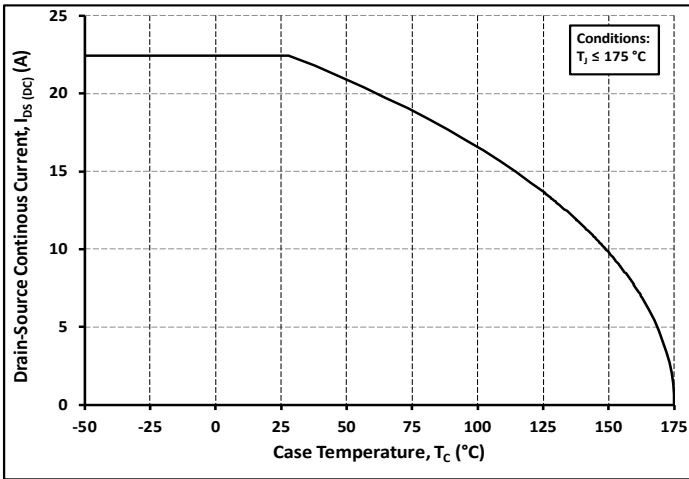

Figure 19. Continuous Drain Current Derating vs. Case Temperature

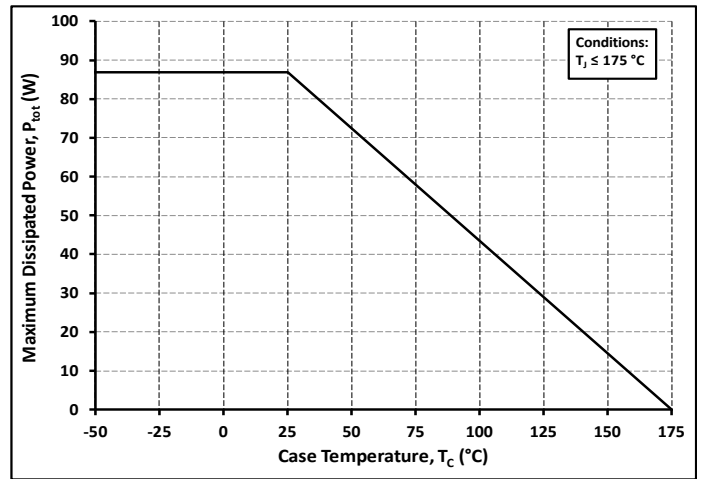

Figure 20. Maximum Power Dissipation Derating vs. Case Temperature

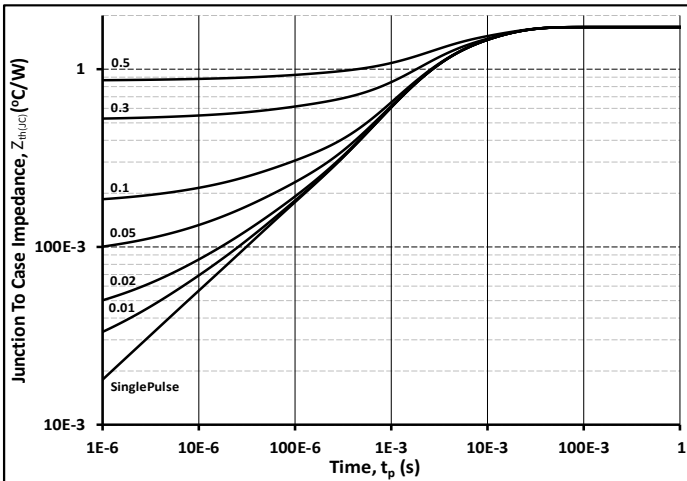

Figure 21. Transient Thermal Impedance (Junction - Case)

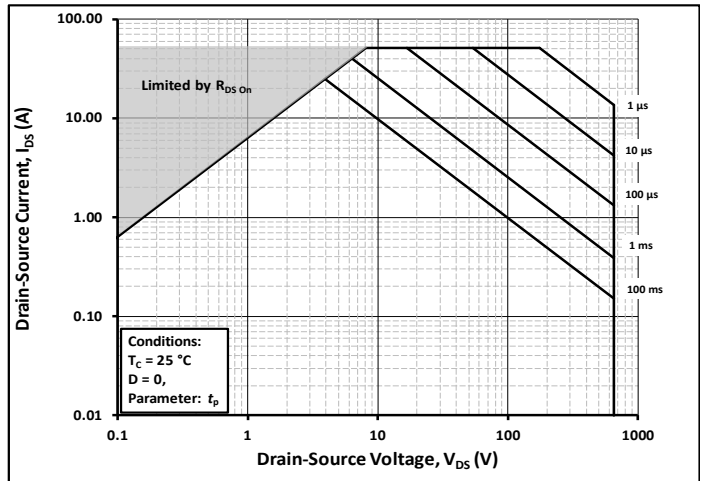

Figure 22. Safe Operating Area

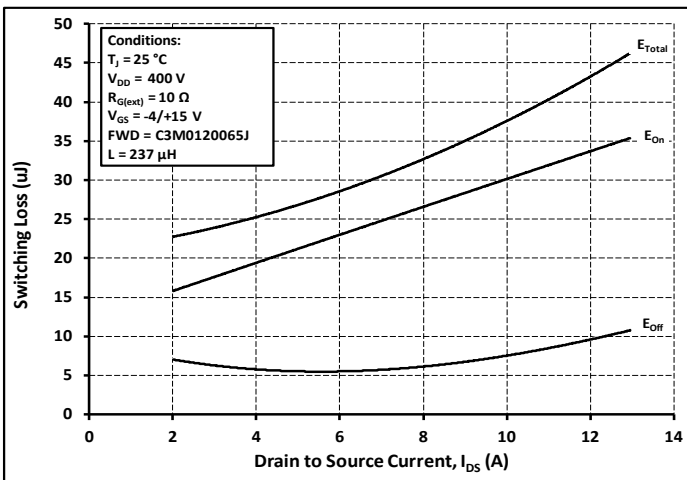

Figure 23. Clamped Inductive Switching Energy vs. Drain Current ( $V_{DD} = 400\text{ V}$ )

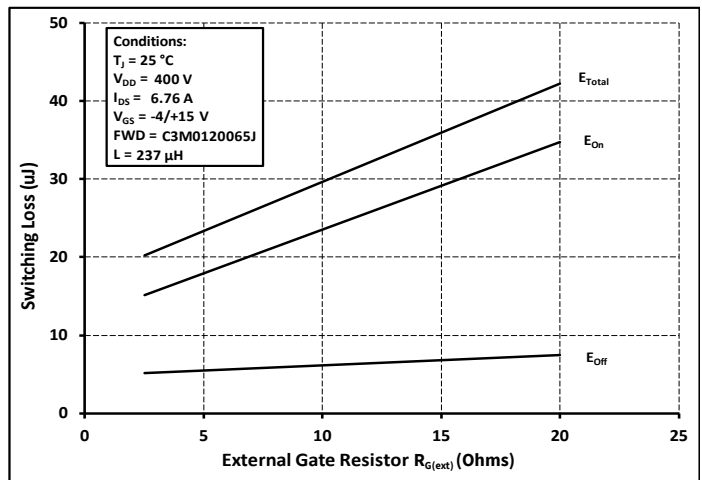

Figure 24. Clamped Inductive Switching Energy vs.  $R_{G(ext)}$



Typical Performance

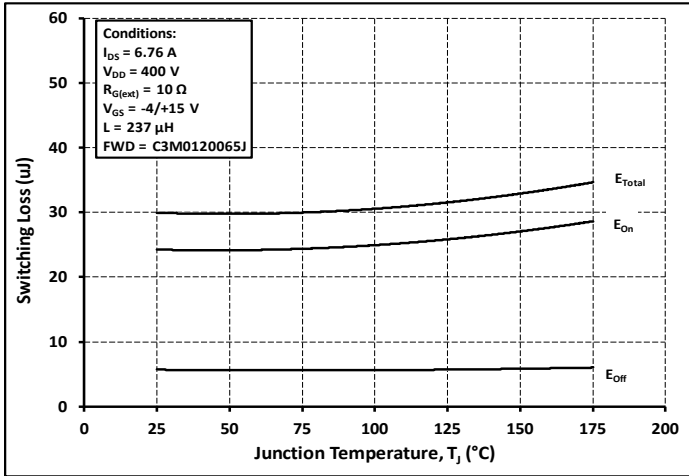

Figure 25. Clamped Inductive Switching Energy vs. Temperature

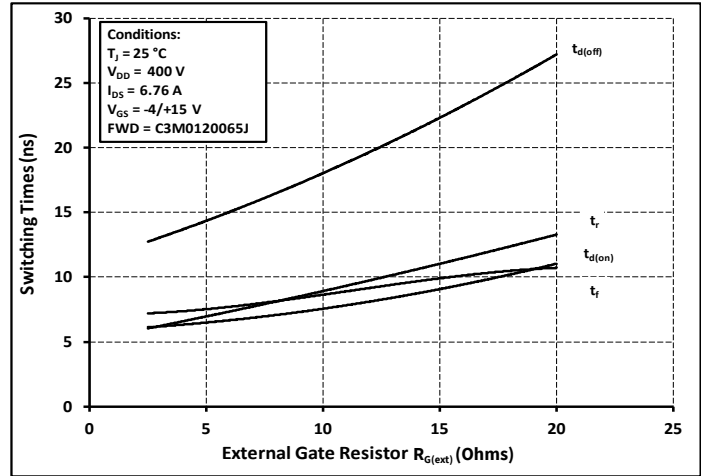
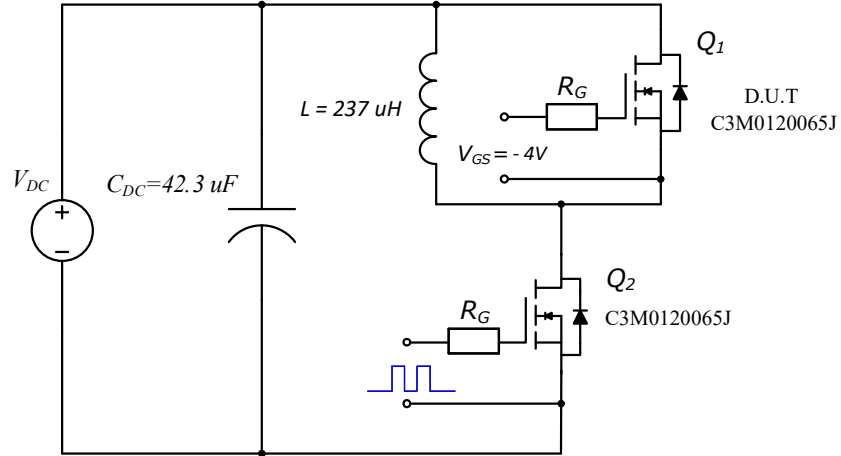

Figure 26. Switching Times vs.  $R_{G(ext)}$



## Test Circuit Schematic



**Figure 27.** Clamped Inductive Switching Waveform Test Circuit



**Package Dimensions – Package 7L D2PAK**

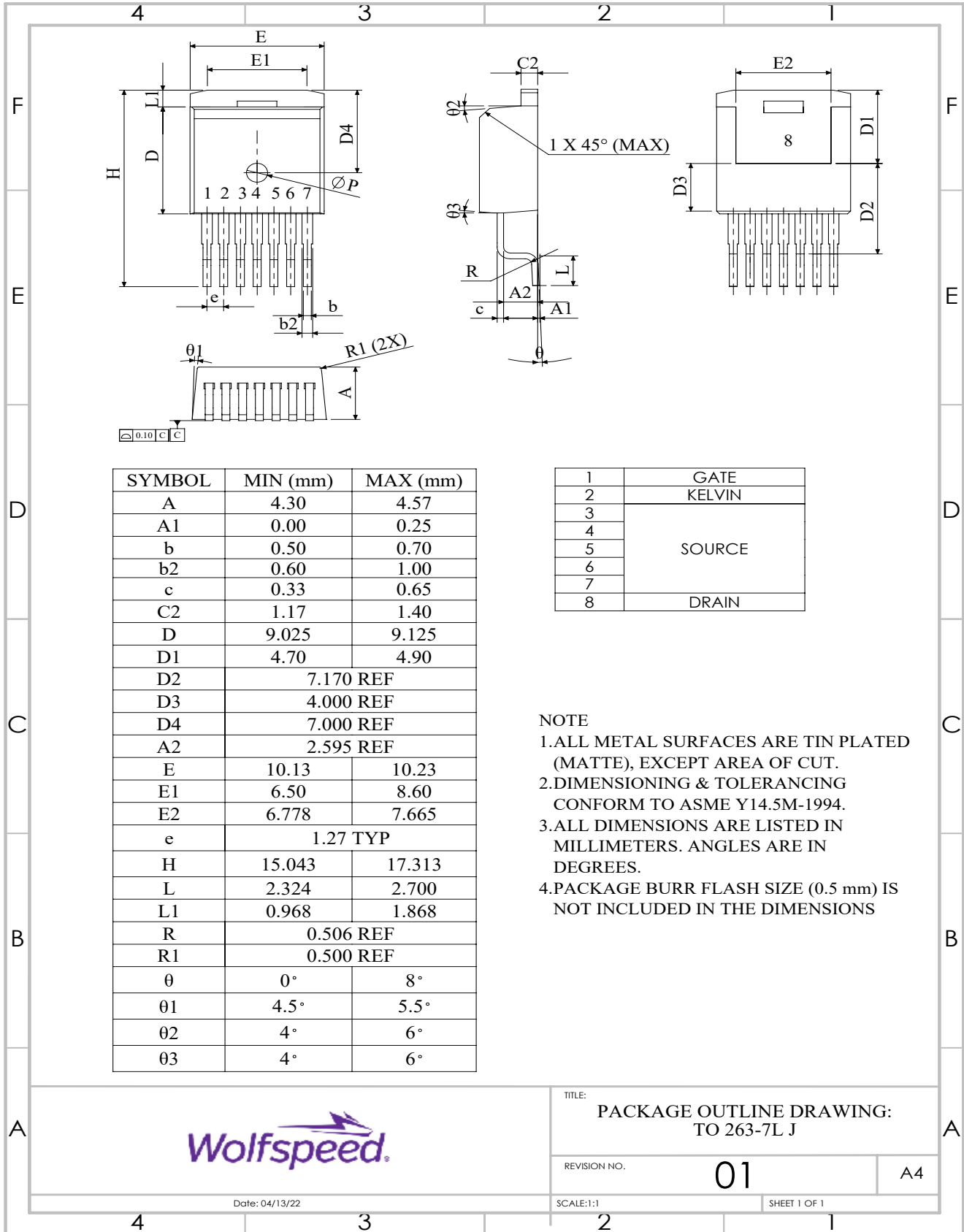

**NOTE**  
 1. ALL METAL SURFACES ARE TIN PLATED (MATTE), EXCEPT AREA OF CUT.  
 2. DIMENSIONING & TOLERANCING CONFORM TO ASME Y14.5M-1994.  
 3. ALL DIMENSIONS ARE LISTED IN MILLIMETERS. ANGLES ARE IN DEGREES.  
 4. PACKAGE BURR FLASH SIZE (0.5 mm) IS NOT INCLUDED IN THE DIMENSIONS



TITLE:  
**PACKAGE OUTLINE DRAWING:  
 TO 263-7L J**

REVISION NO. **01** A4

Date: 04/13/22

SCALE: 1:1

SHEET 1 OF 1



## Recommended Solder Pad Layout

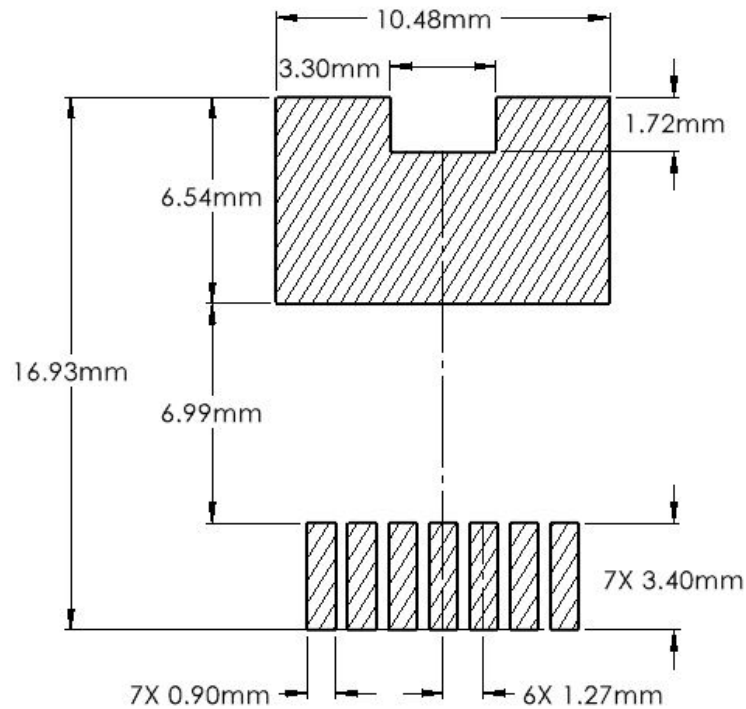

## Revision History

Current Revision	Date of Release	Description of Changes
1	January-2021	N/A
2	December-2023	Updated Wolfspeed branding, package drawing, package image, solder pad layout, added Rev history, Table 1 layout revised

## Related Links

- [SPICE Models](#)
- [SiC MOSFET Isolated Gate Driver reference design](#)
- [SiC MOSFET Evaluation Board](#)



## Notes & Disclaimer

---

This document and the information contained herein are subject to change without notice. Any such change shall be evidenced by the publication of an updated version of this document by Wolfspeed. No communication from any employee or agent of Wolfspeed or any third party shall effect an amendment or modification of this document. No responsibility is assumed by Wolfspeed for any infringement of patents or other rights of third parties which may result from use of the information contained herein. No license is granted by implication or otherwise under any patent or patent rights of Wolfspeed.

Notwithstanding any application-specific information, guidance, assistance, or support that Wolfspeed may provide, the buyer of this product is solely responsible for determining the suitability of this product for the buyer's purposes, including without limitation for use in the applications identified in the next bullet point, and for the compliance of the buyers' products, including those that incorporate this product, with all applicable legal, regulatory, and safety-related requirements.

This product has not been designed or tested for use in, and is not intended for use in, applications in which failure of the product would reasonably be expected to cause death, personal injury, or property damage, including but not limited to equipment implanted into the human body, life-support machines, cardiac defibrillators, and similar emergency medical equipment, aircraft navigation, communication, and control systems, aircraft power and propulsion systems, air traffic control systems, and equipment used in the planning, construction, maintenance, or operation of nuclear facilities.

The Silicon Carbide MOSFET module switches at speeds beyond what is customarily associated with IGBT-based modules. Therefore, special precautions are required to realize optimal performance. The interconnection between the gate driver and module housing needs to be as short as possible. This will afford optimal switching time and avoid the potential for device oscillation. Also, great care is required to insure minimum inductance between the module and DC link capacitors to avoid excessive VDS overshoot.

### RoHS Compliance

The levels of RoHS restricted materials in this product are below the maximum concentration values (also referred to as the threshold limits) permitted for such substances, or are used in an exempted application, in accordance with EU Directive 2011/65/EC (RoHS2), as implemented January 2, 2013. RoHS Declarations for this product can be obtained from your Wolfspeed representative or from the Product Documentation sections of [www.wolfspeed.com](http://www.wolfspeed.com).

### REACH Compliance

REACH substances of high concern (SVHCs) information is available for this product. Since the European Chemical Agency (ECHA) has published notice of their intent to frequently revise the SVHC listing for the foreseeable future, please contact your Wolfspeed representative to ensure you get the most up-to-date REACH SVHC Declaration. REACH banned substance information (REACH Article 67) is also available upon request.

### Contact info:

4600 Silicon Drive  
Durham, NC 27703 USA  
Tel: +1.919.313.5300  
[www.wolfspeed.com/power](http://www.wolfspeed.com/power)