

# E3M0016120K

Silicon Carbide Power MOSFET  
E-Series Automotive  
N-Channel Enhancement Mode



## Features

- 3rd generation SiC MOSFET technology
- Optimized package with separate driver source pin
- 8mm of creepage distance between drain and source
- High blocking voltage with low on-resistance
- High-speed switching with low capacitances
- Fast intrinsic diode with low reverse recovery ( $Q_{rr}$ )
- Halogen free, RoHS compliant
- Automotive Qualified (AEC-Q101) and PPAP Capable

## Benefits

- Reduce switching losses and minimize gate ringing
- Higher system efficiency
- Reduce cooling requirements
- Increase power density
- Increase system switching frequency

## Applications

- Motor Control
- EV Battery Chargers
- High Voltage DC/DC Converters

## Package

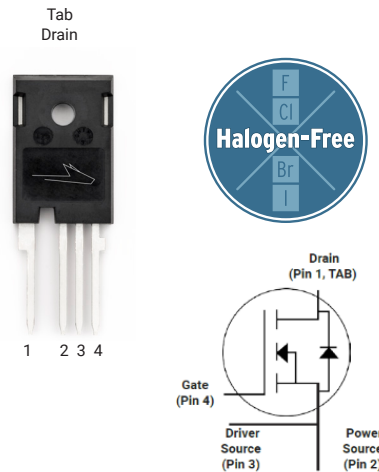

Part Number	Package	Marking
E3M0016120K	TO-247-4L	E3M0016120K

## Maximum Ratings ( $T_c = 25^\circ\text{C}$ unless otherwise specified)

Symbol	Parameter	Value	Unit	Note	
$V_{DSmax}$	Drain - Source Voltage	1200	V		
$V_{GSmax}$	Gate - Source Voltage	-8/+19	V	Note: 1	
$I_D$	Continuous Drain Current, $V_{GS} = 15\text{ V}$	$T_c = 25^\circ\text{C}$	125	A	Fig. 19 Note: 2
		$T_c = 100^\circ\text{C}$	90		
$I_{D(pulse)}$	Pulsed Drain Current, Pulse width $t_p$ limited by $T_{jmax}$	321	A	Fig. 22	
$P_D$	Power Dissipation, $T_c=25^\circ\text{C}$ , $T_j = 175^\circ\text{C}$	483	W	Fig. 20 Note: 2	
$T_j, T_{stg}$	Operating Junction and Storage Temperature	-55 to +175	$^\circ\text{C}$		
$T_L$	Solder Temperature, 1.6mm (0.063") from case for 10s	260	$^\circ\text{C}$		
$M_d$	Mounting Torque , M3 or 6-32 screw	1	Nm lbf-in		
		8.8			

Note (1): Recommended turn off / turn on gate voltage  $V_{GS} = -4V...0V / +15V$

Note (2): Verified by design

**Electrical Characteristics** ( $T_C = 25^\circ\text{C}$  unless otherwise specified)

Symbol	Parameter	Min.	Typ.	Max.	Unit	Test Conditions	Note
$V_{(BR)DSS}$	Drain-Source Breakdown Voltage	1200			V	$V_{GS} = 0\text{ V}, I_D = 100\ \mu\text{A}$	
$V_{GS(th)}$	Gate Threshold Voltage	1.8	2.5	3.6	V	$V_{DS} = V_{GS}, I_D = 22.08\ \text{mA}$	Fig. 11
			2.1		V	$V_{DS} = V_{GS}, I_D = 22.08\ \text{mA}, T_J = 175^\circ\text{C}$	
$I_{DSS}$	Zero Gate Voltage Drain Current		1	50	$\mu\text{A}$	$V_{DS} = 1200\ \text{V}, V_{GS} = 0\ \text{V}$	
$I_{GSS}$	Gate-Source Leakage Current		10	250	nA	$V_{GS} = 15\ \text{V}, V_{DS} = 0\ \text{V}$	
$R_{DS(on)}$	Drain-Source On-State Resistance	11	16	22	m $\Omega$	$V_{GS} = 15\ \text{V}, I_D = 80.28\ \text{A}$	Fig. 4, 5, 6
			29			$V_{GS} = 15\ \text{V}, I_D = 80.28\ \text{A}, T_J = 175^\circ\text{C}$	
$g_{fs}$	Transconductance		54		S	$V_{DS} = 20\ \text{V}, I_{DS} = 84.8\ \text{A}$	Fig. 7
			49			$V_{DS} = 20\ \text{V}, I_{DS} = 80.9\ \text{A}, T_J = 175^\circ\text{C}$	
$C_{iss}$	Input Capacitance		6922		pF	$V_{GS} = 0\ \text{V}, V_{DS} = 0\ \text{V to } 1000\ \text{V}$ $F = 100\ \text{kHz}$ $V_{AC} = 25\ \text{mV}$	Fig. 17, 18
$C_{oss}$	Output Capacitance		231				
$C_{rss}$	Reverse Transfer Capacitance		13				
$E_{oss}$	$C_{oss}$ Stored Energy		127		$\mu\text{J}$		Fig. 16
$C_{o(er)}$	Effective Output Capacitance (Energy Related)		268		pF	$V_{GS} = 0\ \text{V}, V_{DS} = 0... 800\ \text{V}$	Note: 3
$C_{o(tr)}$	Effective Output Capacitance (Time Related)		404				
$E_{oN}$	Turn-On Switching Energy (External Diode)		1287		$\mu\text{J}$	$V_{DS} = 800\ \text{V}, V_{GS} = -4\ \text{V}/15\ \text{V}, I_D = 80.28\ \text{A},$ $R_{G(ext)} = 2.5\ \Omega, L = 59\ \mu\text{H}, T_J = 175^\circ\text{C}$ FWD = External SiC DIODE	Fig. 26, 28
$E_{oOFF}$	Turn Off Switching Energy (External Diode)		805				
$E_{oN}$	Turn-On Switching Energy (Body Diode FWD)		2552		$\mu\text{J}$	$V_{DS} = 800\ \text{V}, V_{GS} = -4\ \text{V}/15\ \text{V}, I_D = 80.28\ \text{A},$ $R_{G(ext)} = 2.5\ \Omega, L = 135\ \mu\text{H}, T_J = 175^\circ\text{C}$ FWD = Internal Body Diode	Fig. 26, 28
$E_{oOFF}$	Turn-Off Switching Energy (Body Diode FWD)		788				
$t_{d(on)}$	Turn-On Delay Time		19		ns	$V_{DD} = 800\ \text{V}, V_{GS} = -4\ \text{V}/15\ \text{V}$ $I_D = 80.28\ \text{A}, R_{G(ext)} = 2.5\ \Omega,$ Timing relative to $V_{DS}$ Inductive load	Fig. 27, 28
$t_r$	Rise Time		40				
$t_{d(off)}$	Turn-Off Delay Time		62				
$t_f$	Fall Time		13				
$R_{G(int)}$	Internal Gate Resistance		2.6		$\Omega$	$f = 1\ \text{MHz}, V_{AC} = 25\ \text{mV}$	
$Q_{gs}$	Gate to Source Charge		70		nC	$V_{DS} = 800\ \text{V}, V_{GS} = -4\ \text{V}/15\ \text{V}$ $I_D = 80.28\ \text{A}$ Per IEC60747-8-4 pg 21	Fig. 12
$Q_{gd}$	Gate to Drain Charge		65				
$Q_g$	Total Gate Charge		223				

Note (3):  $C_{o(er)}$ , a lumped capacitance that gives same stored energy as  $C_{oss}$  while  $V_{ds}$  is rising from 0 to 800V  
 $C_{o(tr)}$ , a lumped capacitance that gives same charging time as  $C_{oss}$  while  $V_{ds}$  is rising from 0 to 800V

**Reverse Diode Characteristics** ( $T_c = 25^\circ\text{C}$  unless otherwise specified)

Symbol	Parameter	Typ.	Max.	Unit	Test Conditions	Note
$V_{SD}$	Diode Forward Voltage	4.9		V	$V_{GS} = -4\text{ V}, I_{SD} = 40.14\text{ A}, T_J = 25^\circ\text{C}$	Fig. 8, 9, 10
		4.4		V	$V_{GS} = -4\text{ V}, I_{SD} = 40.14\text{ A}, T_J = 175^\circ\text{C}$	
$I_S$	Continuous Diode Forward Current		88	A	$V_{GS} = -4\text{ V}, T_c = 25^\circ\text{C}$	
$I_{S, pulse}$	Diode pulse Current		321	A	$V_{GS} = -4\text{ V}$ , pulse width $t_p$ limited by $T_{jmax}$	
$t_{rr}$	Reverse Recover time	32		ns	$V_{GS} = -4\text{ V}, I_{SD} = 80.28\text{ A}, V_R = 800\text{ V}$ $dif/dt = 5180\text{ A}/\mu\text{s}, T_J = 175^\circ\text{C}$	
$Q_{rr}$	Reverse Recovery Charge	1665		nC		
$I_{rrm}$	Peak Reverse Recovery Current	82		A		
$t_{rr}$	Reverse Recover time	46		ns	$V_{GS} = -4\text{ V}, I_{SD} = 80.28\text{ A}, V_R = 800\text{ V}$ $dif/dt = 2760\text{ A}/\mu\text{s}, T_J = 175^\circ\text{C}$	
$Q_{rr}$	Reverse Recovery Charge	1365		nC		
$I_{rrm}$	Peak Reverse Recovery Current	45		A		

**Thermal Characteristics**

Symbol	Parameter	Typ.	Max.	Unit	Test Conditions	Note
$R_{\theta JC}$	Thermal Resistance from Junction to Case	0.23	0.31	$^\circ\text{C}/\text{W}$		Fig. 21



Typical Performance

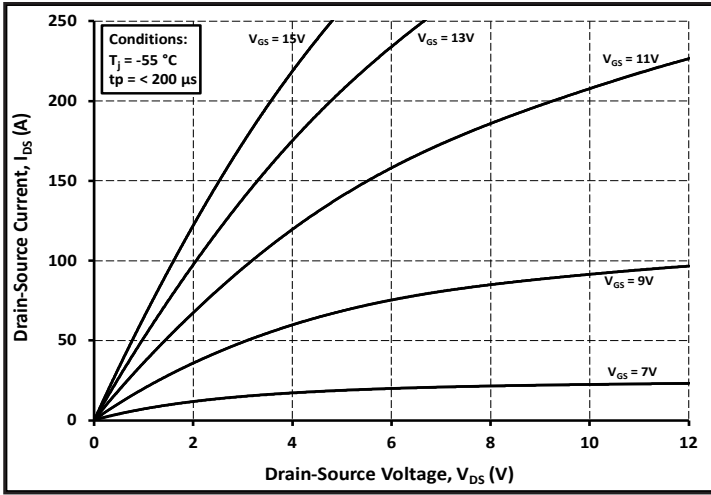

Figure 1. Output Characteristics  $T_j = -55\text{ }^\circ\text{C}$

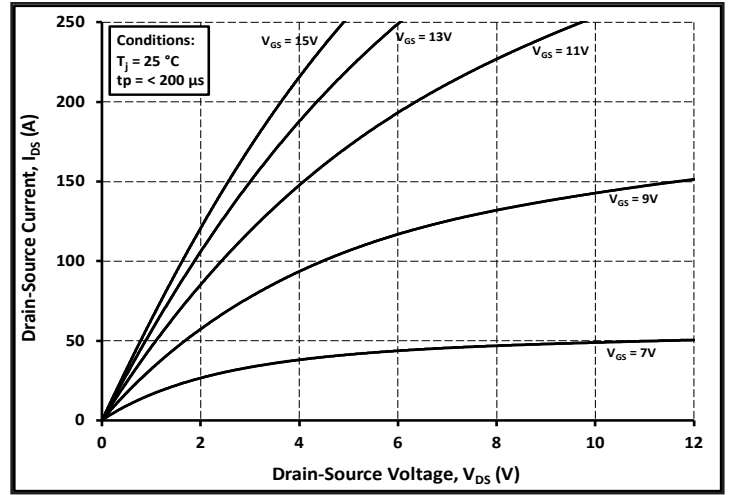

Figure 2. Output Characteristics  $T_j = 25\text{ }^\circ\text{C}$

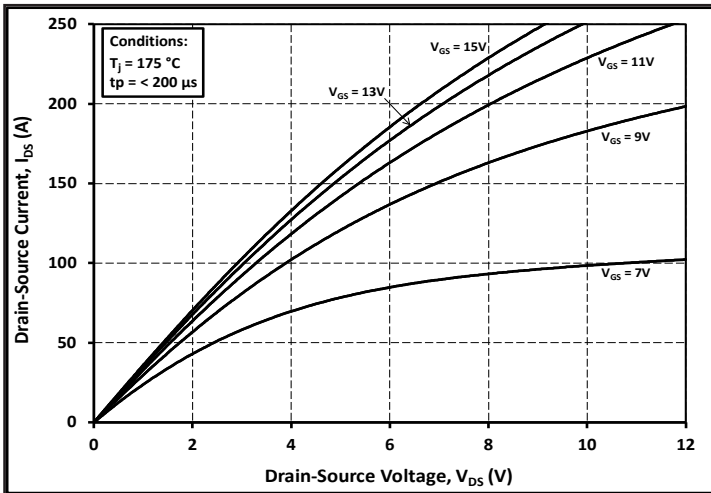

Figure 3. Output Characteristics  $T_j = 175\text{ }^\circ\text{C}$

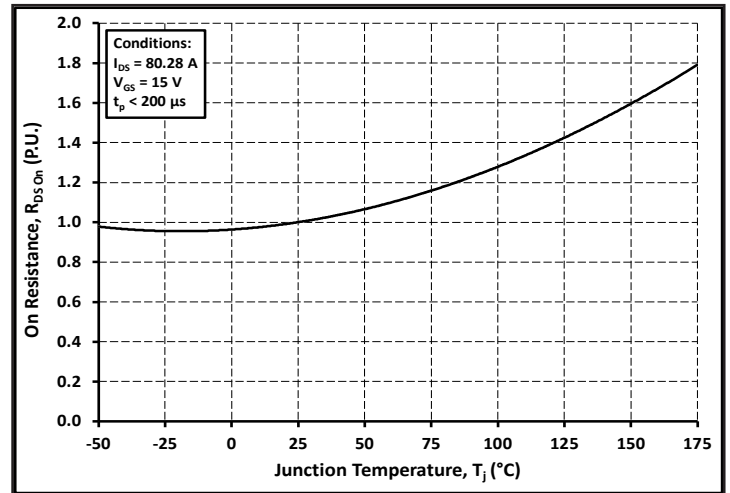

Figure 4. Normalized On-Resistance vs. Temperature

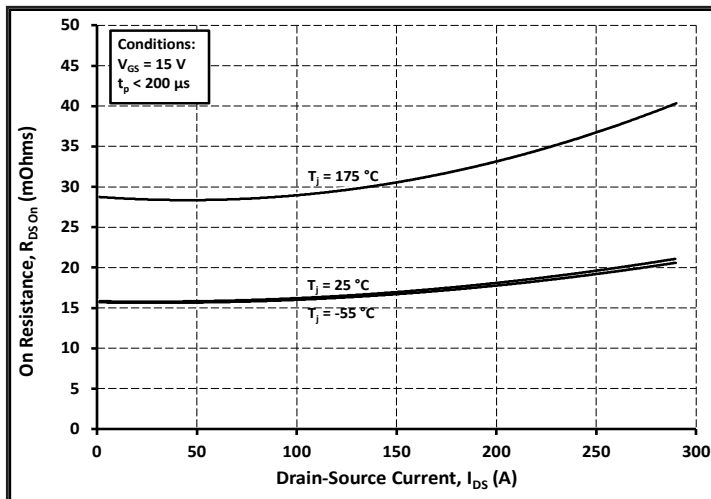

Figure 5. On-Resistance vs. Drain Current For Various Temperatures

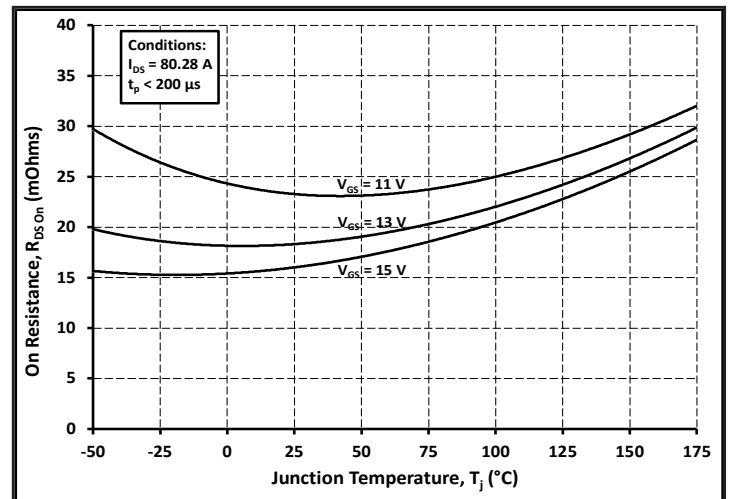

Figure 6. On-Resistance vs. Temperature For Various Gate Voltage

Typical Performance

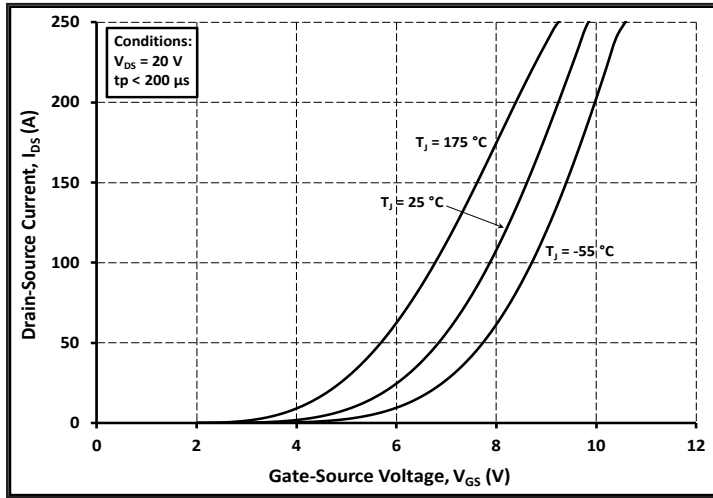

Figure 7. Transfer Characteristic for Various Junction Temperatures

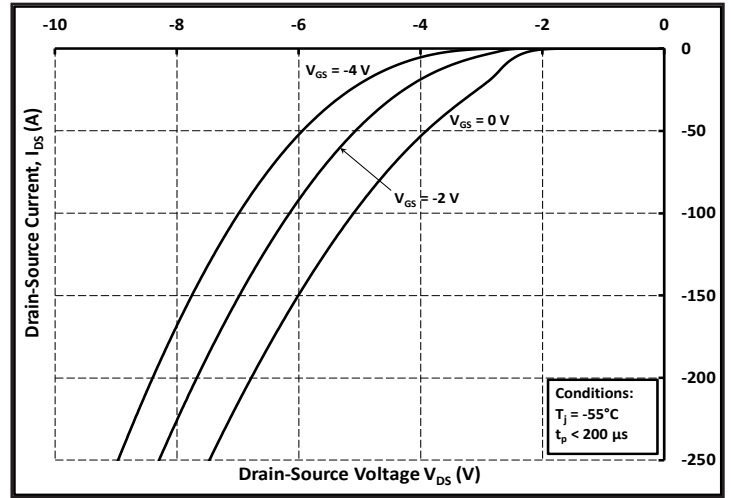

Figure 8. Body Diode Characteristic at -55 °C

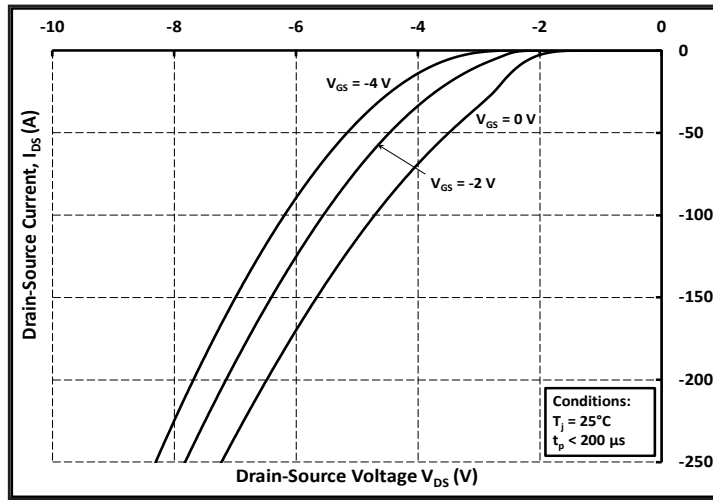

Figure 9. Body Diode Characteristic at 25 °C

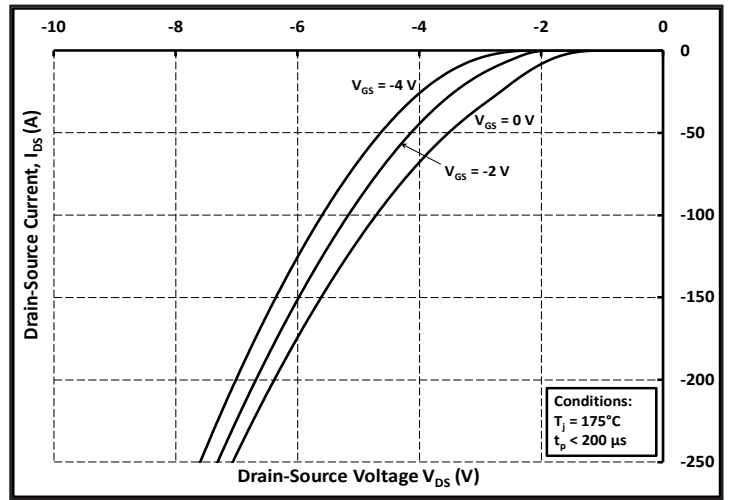

Figure 10. Body Diode Characteristic at 175 °C

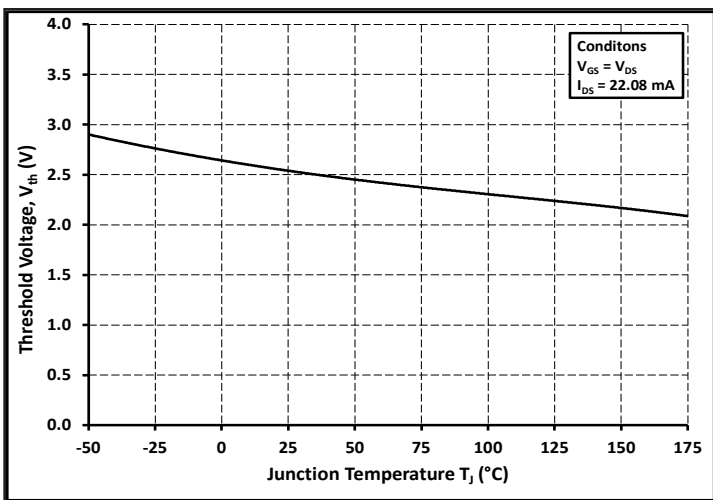

Figure 11. Threshold Voltage vs. Temperature

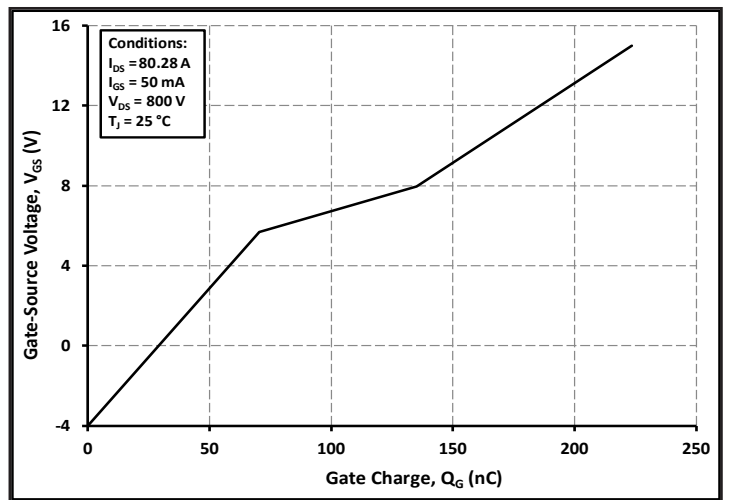

Figure 12. Gate Charge Characteristics



Typical Performance

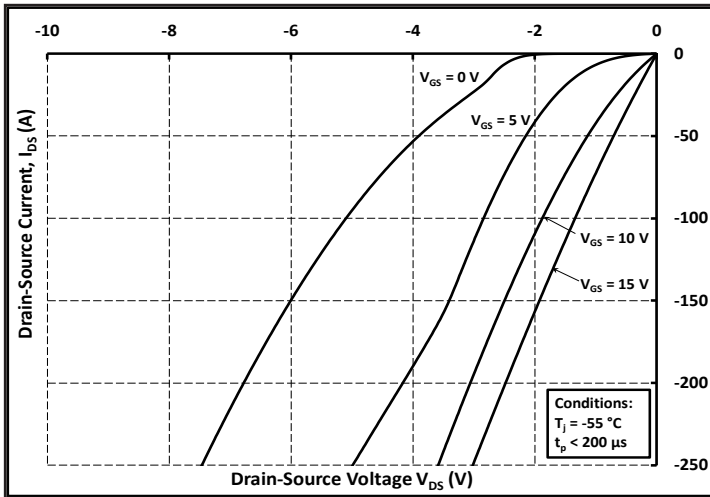

Figure 13. 3rd Quadrant Characteristic at -55 °C

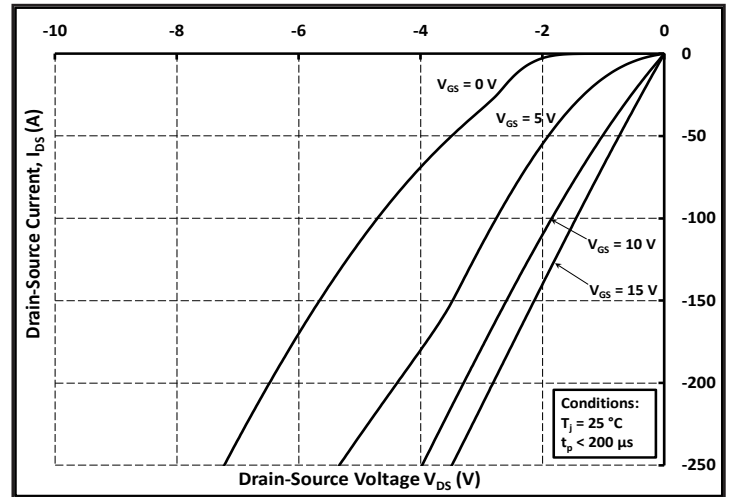

Figure 14. 3rd Quadrant Characteristic at 25 °C

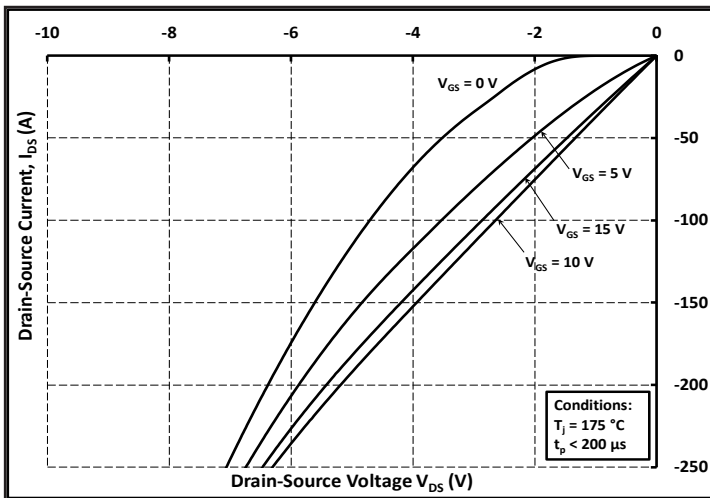

Figure 15. 3rd Quadrant Characteristic at 175 °C

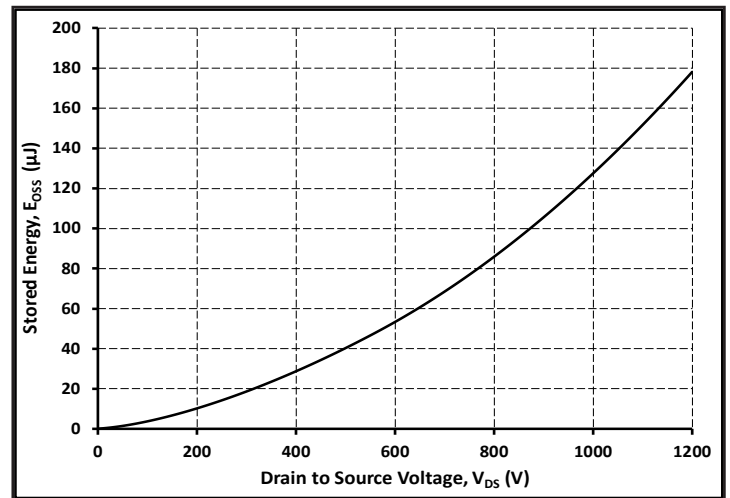

Figure 16. Output Capacitor Stored Energy

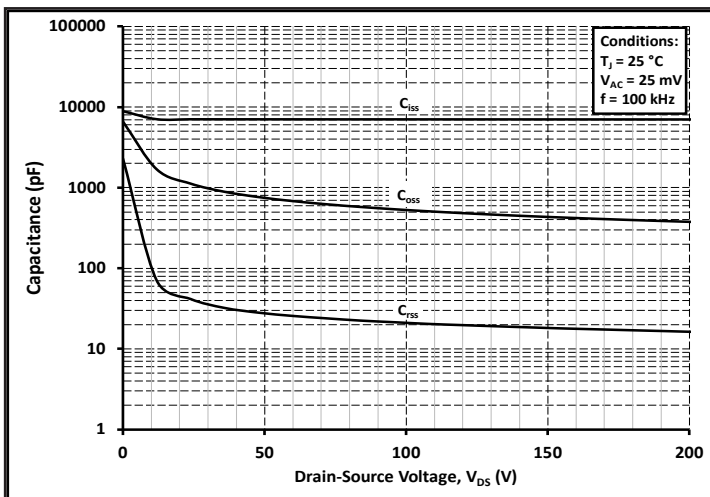

Figure 17. Capacitances vs. Drain-Source Voltage (0 - 200V)

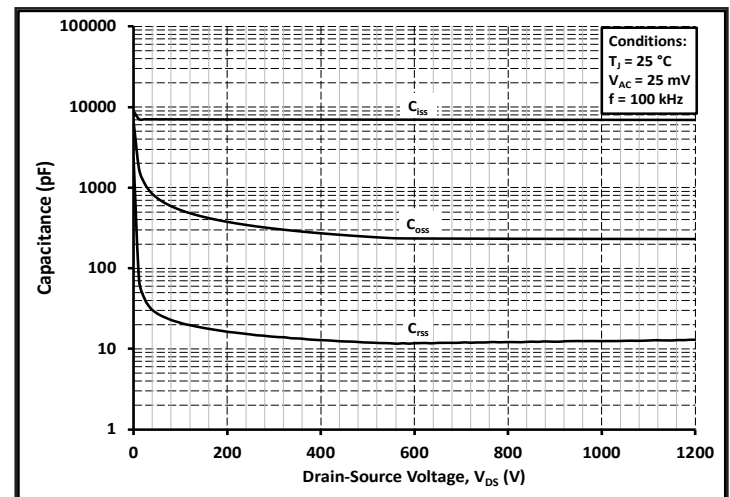

Figure 18. Capacitances vs. Drain-Source Voltage (0 - 1200V)



Typical Performance

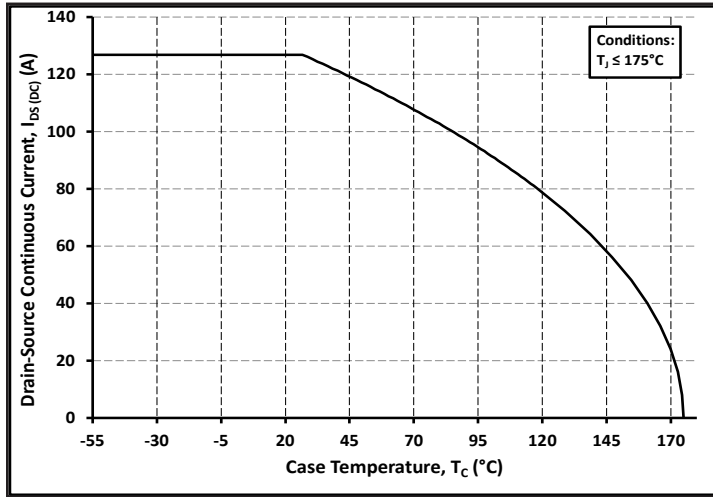

Figure 19. Continuous Drain Current Derating vs. Case Temperature

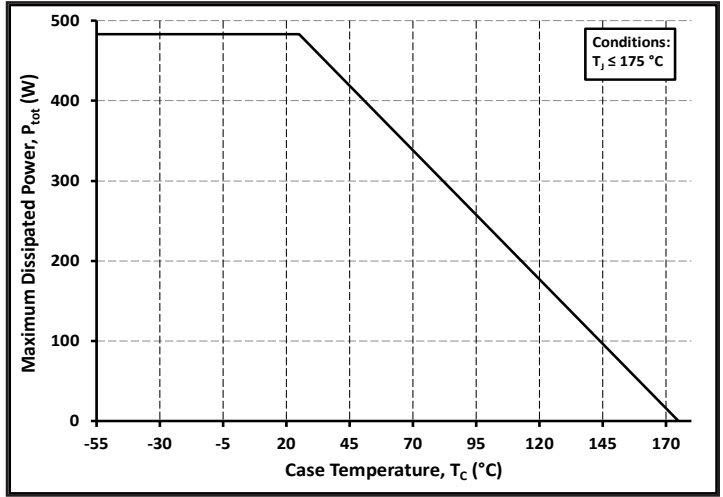

Figure 20. Maximum Power Dissipation Derating vs. Case Temperature

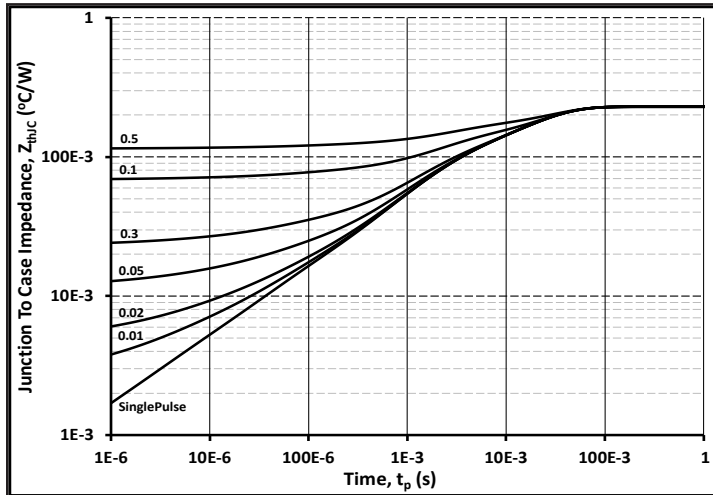

Figure 21. Transient Thermal Impedance (Junction - Case)

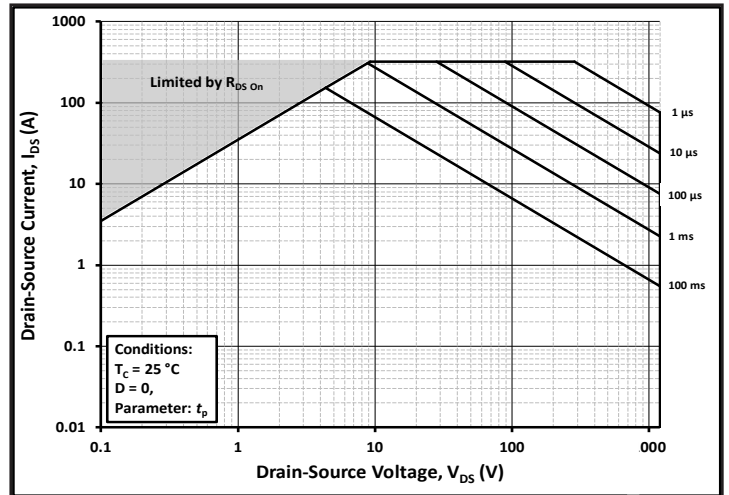

Figure 22. Safe Operating Area

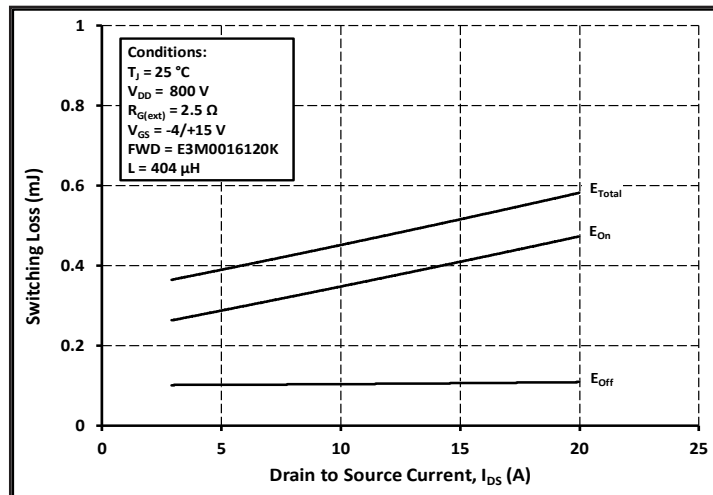

Figure 23. Clamped Inductive Switching Energy vs. Low Drain Current ( $V_{DD} = 800V$ )

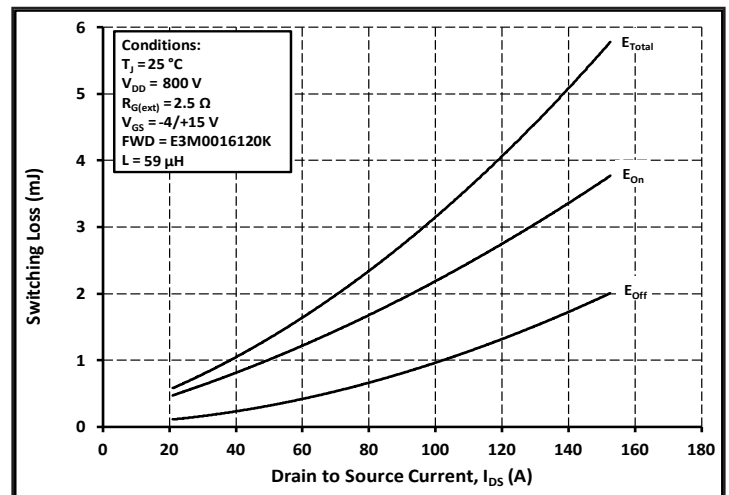

Figure 24. Clamped Inductive Switching Energy vs. High Drain Current ( $V_{DD} = 800V$ )

Typical Performance

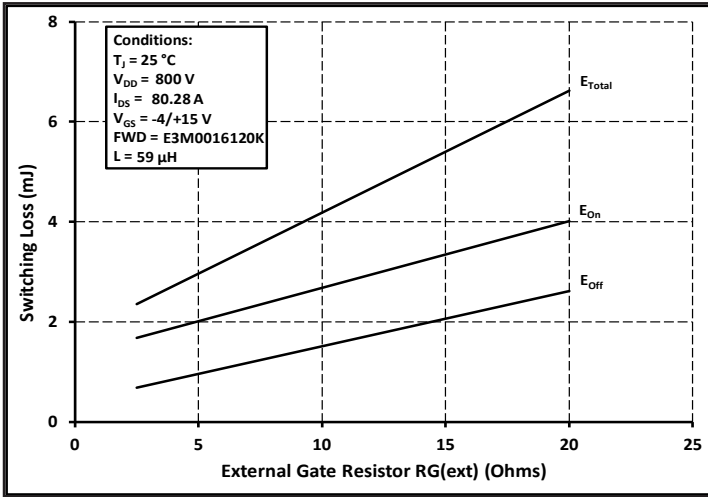

Figure 25. Clamped Inductive Switching Energy vs.  $R_{G(ext)}$

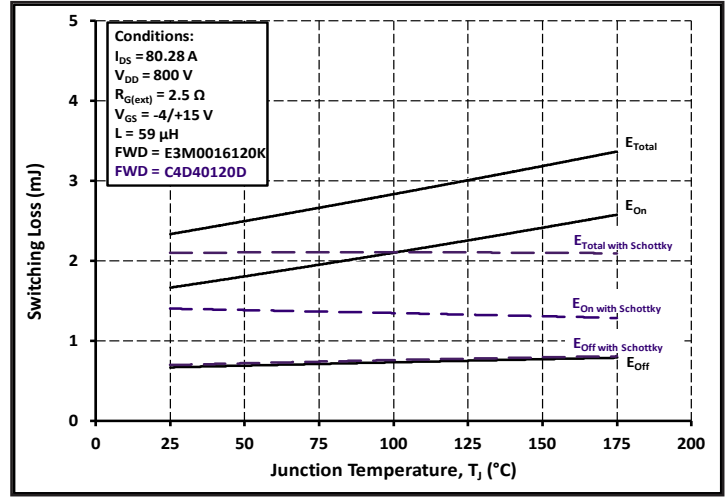

Figure 26. Clamped Inductive Switching Energy vs. Temperature

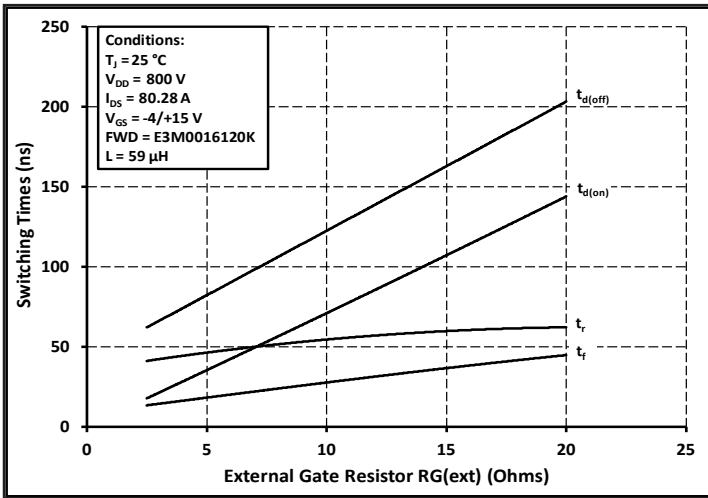

Figure 27. Switching Times vs.  $R_{G(ext)}$

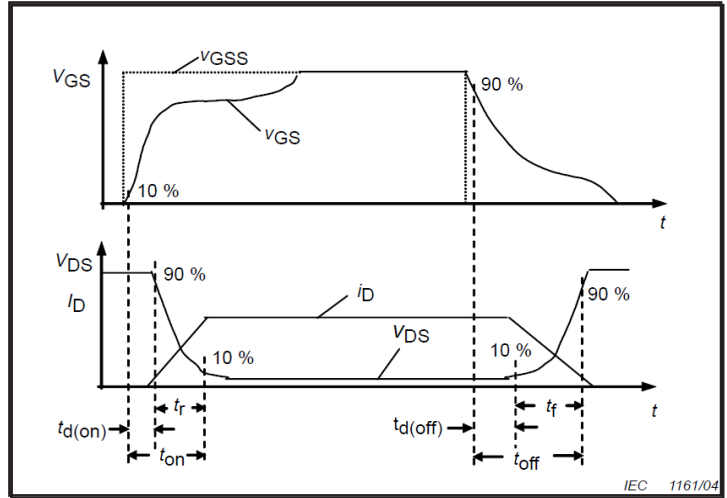

Figure 28. Switching Times Definition



## Test Circuit Schematic

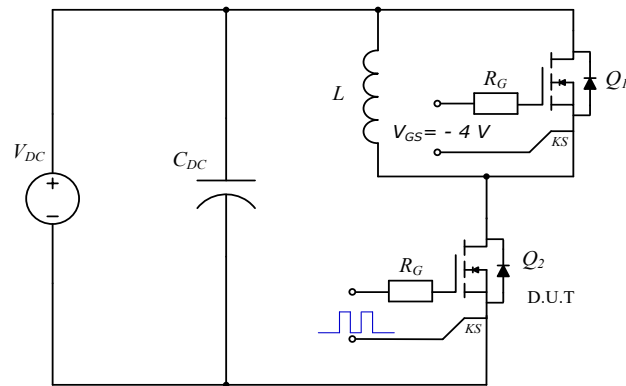
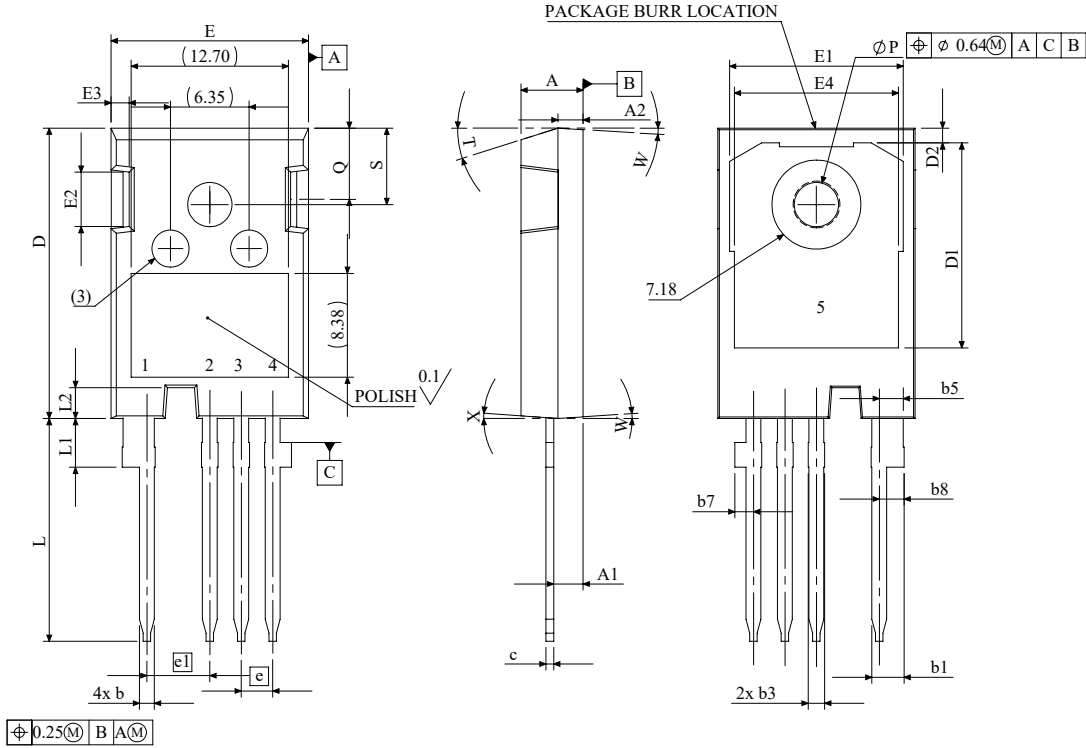

Figure 29. Clamped Inductive Switching Waveform Test Circuit

Package Dimensions



SYMBOL	MIN (mm)	MAX (mm)
A	4.83	5.21
A1	2.29	2.54
A2	1.91	2.16
b	1.07	1.33
b1	2.39	2.94
b3	1.07	1.60
b5	2.39	2.69
b7	1.30	1.70
b8	1.80	2.20
c	0.55	0.68
D	23.30	23.60
D1	16.25	17.65
D2	0.95	1.25
E	15.75	16.13
E1	13.1	14.15
E2	3.68	5.10
E3	1.00	1.90
E4	12.38	13.43
e	2.54 BSC	
e1	5.08 BSC	
L	17.31	17.82
L1	3.97	4.37
L2	2.35	2.65
ØP	3.51	3.65
Q	5.49	6.00
S	6.04	6.30
T	17.5° REF.	
W	3.5° REF.	
X	4° REF.	

1	DRAIN
2	SOURCE
3	DRIVER SOURCE
4	GATE
5	DRAIN

- NOTE:
1. ALL METAL SURFACES ARE TIN PLATED (MATTE), EXCEPT AREA OF CUT.
  2. DIMENSIONING & TOLERANCING CONFORM TO ASME Y14.5M-1994.
  3. ALL DIMENSIONS ARE LISTED IN MILLIMETERS. ANGLES ARE IN DEGREES.
  4. BURR OR MOLD FLASH SIZE (0.5 mm) IS NOT INCLUDED IN THE DIMENSIONS



### Recommended Solder Pad Layout

---

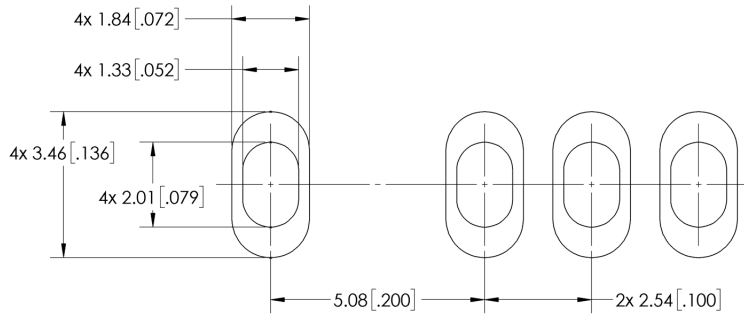



## Revision history

---

Document Version	Date of release	Description of changes
1.0	January-2023	Initial datasheet



## Notes & Disclaimer

---

This document and the information contained herein are subject to change without notice. Any such change shall be evidenced by the publication of an updated version of this document by Wolfspeed. No communication from any employee or agent of Wolfspeed or any third party shall effect an amendment or modification of this document. No responsibility is assumed by Wolfspeed for any infringement of patents or other rights of third parties which may result from use of the information contained herein. No license is granted by implication or otherwise under any patent or patent rights of Wolfspeed.

Notwithstanding any application-specific information, guidance, assistance, or support that Wolfspeed may provide, the buyer of this product is solely responsible for determining the suitability of this product for the buyer's purposes, including without limitation for use in the applications identified in the next bullet point, and for the compliance of the buyers' products, including those that incorporate this product, with all applicable legal, regulatory, and safety-related requirements.

This product has not been designed or tested for use in, and is not intended for use in, applications in which failure of the product would reasonably be expected to cause death, personal injury, or property damage, including but not limited to equipment implanted into the human body, life-support machines, cardiac defibrillators, and similar emergency medical equipment, aircraft navigation, communication, and control systems, aircraft power and propulsion systems, air traffic control systems, and equipment used in the planning, construction, maintenance, or operation of nuclear facilities.

### **RoHS Compliance**

The levels of RoHS restricted materials in this product are below the maximum concentration values (also referred to as the threshold limits) permitted for such substances, or are used in an exempted application, in accordance with EU Directive 2011/65/EC (RoHS2), as implemented January 2, 2013. RoHS Declarations for this product can be obtained from your Wolfspeed representative or from the Product Documentation sections of [www.wolfspeed.com](http://www.wolfspeed.com).

### **REACH Compliance**

REACH substances of high concern (SVHCs) information is available for this product. Since the European Chemical Agency (ECHA) has published notice of their intent to frequently revise the SVHC listing for the foreseeable future, please contact your Wolfspeed representative to ensure you get the most up-to-date REACH SVHC Declaration. REACH banned substance information (REACH Article 67) is also available upon request.

### **Contact info:**

4600 Silicon Drive  
Durham, NC 27703 USA  
Tel: +1.919.313.5300  
[www.wolfspeed.com/power](http://www.wolfspeed.com/power)