

# C6D06065G

## 650 V, 6 A Silicon Carbide Schottky Diode

### Description

With the performance advantages of a Silicon Carbide (SiC) Schottky Barrier diode, power electronics systems can expect to meet higher efficiency standards than Si-based solutions, while also reaching higher frequencies and power densities. SiC diodes can be easily paralleled to meet various application demands, without concern of thermal runaway. In combination with the reduced cooling requirements and improved thermal performance of SiC products, SiC diodes are able to provide lower overall system costs in a variety of diverse applications.



TO-263-2



Package Types: TO-263-2

PN: C6D06065G

WolfSpeed, Inc. is in the process of rebranding its products and related materials pursuant to the entity name change from Cree, Inc. to WolfSpeed, Inc. During this transition period, products received may be marked with either the Cree name and/or logo or the WolfSpeed name and/or logo.

### Typical Applications

- Industrial power supplies
- Switch mode power supplies
- Server/telecom power supplies
- Power factor correction
- Solar inverter
- Uninterruptible power supply

### Features

- Low forward voltage ( $V_f$ ) drop with positive temperature coefficient
- Zero reverse recovery current/forward recovery voltage
- Temperature-independent switching behavior
- Low leakage current ( $I_R$ )

### Maximum Ratings ( $T_c = 25\text{ }^\circ\text{C}$ Unless Otherwise Specified)

Parameter	Symbol	Value	Unit	Test Conditions	Note
Repetitive Peak Reverse Voltage	$V_{RRM}$	650	V		
DC Blocking Voltage	$V_{DC}$	650			
Continuous Forward Current	$I_F$	23	A	$T_c = 25\text{ }^\circ\text{C}$	Fig. 3
		12		$T_c = 125\text{ }^\circ\text{C}$	
		6		$T_c = 155\text{ }^\circ\text{C}$	
Repetitive Peak Forward Surge Current	$I_{FRM}$	25	A	$T_c = 25\text{ }^\circ\text{C}$ , $t_p = 10\text{ ms}$ , Half Sine Wave	
		14		$T_c = 110\text{ }^\circ\text{C}$ , $t_p = 10\text{ ms}$ , Half Sine Wave	
Non-Repetitive Peak Forward Surge Current	$I_{FSM}$	45	A	$T_c = 25\text{ }^\circ\text{C}$ , $t_p = 10\text{ ms}$ , Half Sine Wave	Fig. 8
		33		$T_c = 110\text{ }^\circ\text{C}$ , $t_p = 10\text{ ms}$ , Half Sine Wave	
	$I_{F,Max}$	620		$T_c = 25\text{ }^\circ\text{C}$ , $t_p = 10\text{ }\mu\text{s}$ , Pulse	
		570		$T_c = 110\text{ }^\circ\text{C}$ , $t_p = 10\text{ }\mu\text{s}$ , Pulse	
Power Dissipation	$P_{tot}$	73	W	$T_c = 25\text{ }^\circ\text{C}$	Fig. 4
		31		$T_c = 110\text{ }^\circ\text{C}$	



### Electrical Characteristics

Parameter	Symbol	Typ.	Max.	Unit	Test Conditions	Note
Drain-Source Voltage	$V_F$	1.27	1.40	V	$I_F = 6\text{ A}, T_J = 25\text{ }^\circ\text{C}$	Fig. 1
		1.37	1.50		$I_F = 6\text{ A}, T_J = 175\text{ }^\circ\text{C}$	
Reverse Current	$I_R$	2	20	$\mu\text{A}$	$V_R = 650\text{ V}, T_J = 25\text{ }^\circ\text{C}$	Fig. 2
		25	200		$V_R = 650\text{ V}, T_J = 175\text{ }^\circ\text{C}$	
Total Capacitive Charge	$Q_C$	22		nC	$V_R = 400\text{ V}, T_J = 25\text{ }^\circ\text{C}$	Fig. 5
Total Capacitance	C	393		$\text{pF}$	$V_R = 0\text{ V}, T_J = 25\text{ }^\circ\text{C}, f = 1\text{ MHz}$	Fig. 6
		44			$V_R = 200\text{ V}, T_J = 25\text{ }^\circ\text{C}, f = 1\text{ MHz}$	
		36			$V_R = 400\text{ V}, T_J = 25\text{ }^\circ\text{C}, f = 1\text{ MHz}$	
Capacitance Stored Energy	$E_C$	3.5		$\mu\text{J}$	$V_R = 400\text{ V}$	Fig. 7

Note: SiC Schottky Diodes are majority carrier devices, so there is no reverse recovery charge.

### Thermal & Mechanical Characteristics

Parameter	Symbol	Typ.	Unit	Note
Thermal Resistance, Junction to Case	$R_{\theta,JC}$	2.05	$^\circ\text{C/W}$	
Operating Junction & Storage Temperature	$T_J, T_{stg}$	-55 to +175	$^\circ\text{C}$	Fig. 9

### Typical Performance

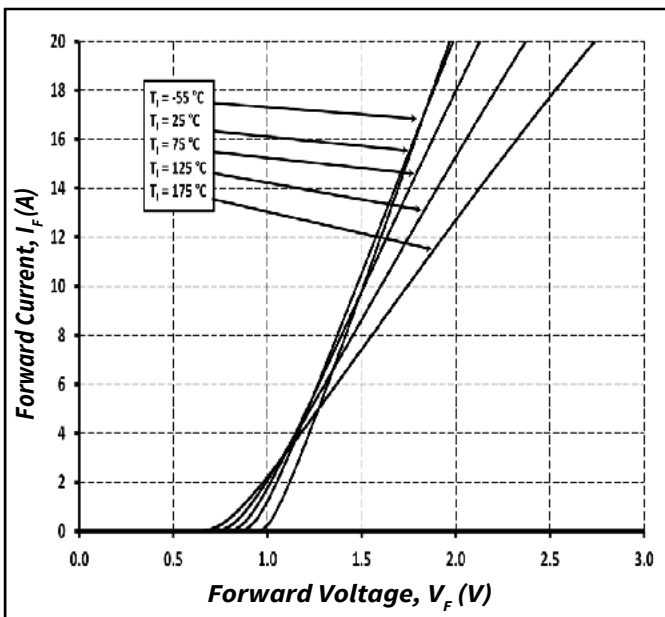

Figure 1. Forward Characteristics

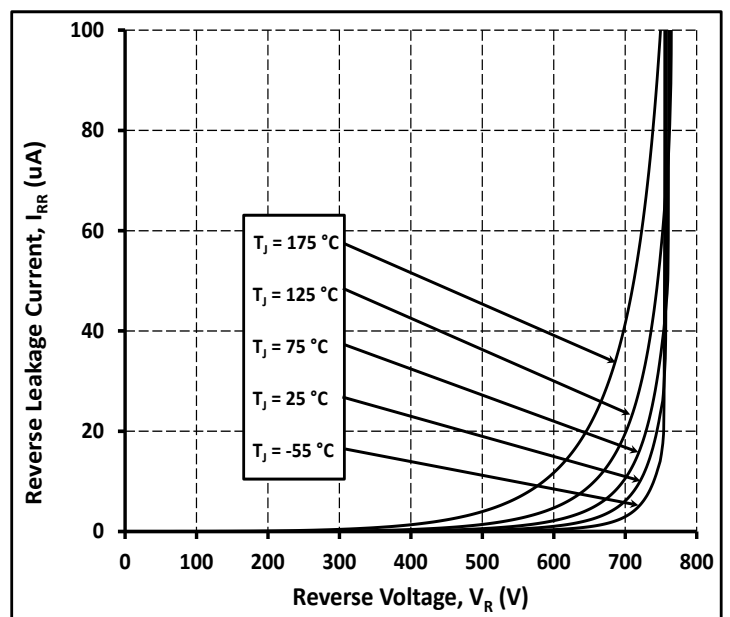

Figure 2. Reverse Characteristics



Typical Performance

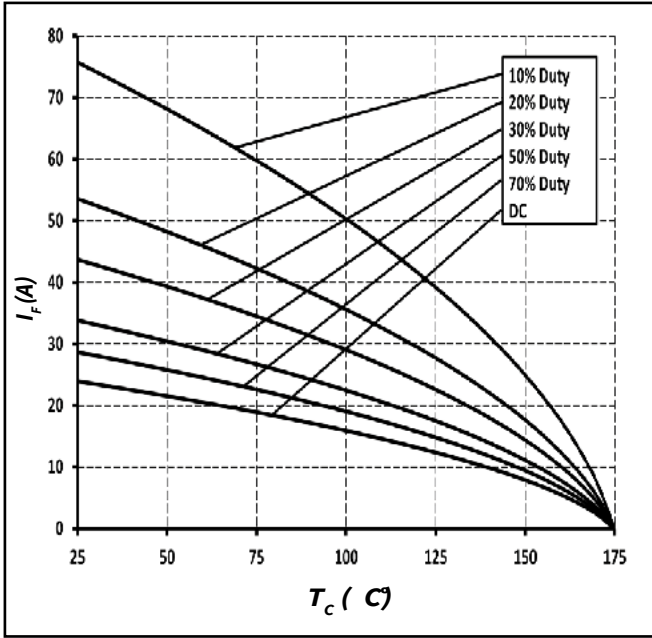

Figure 3. Current Derating

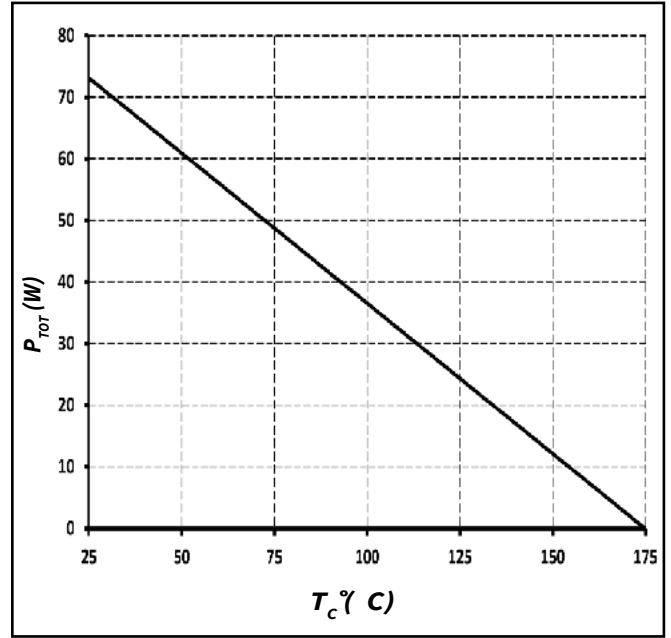

Figure 4. Power Derating

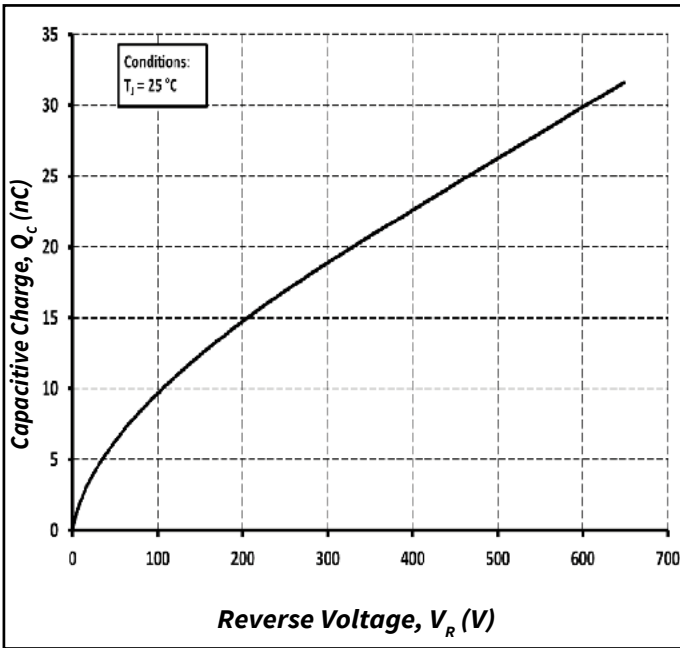

Figure 5. Total Capacitance Charge vs. Reverse Voltage

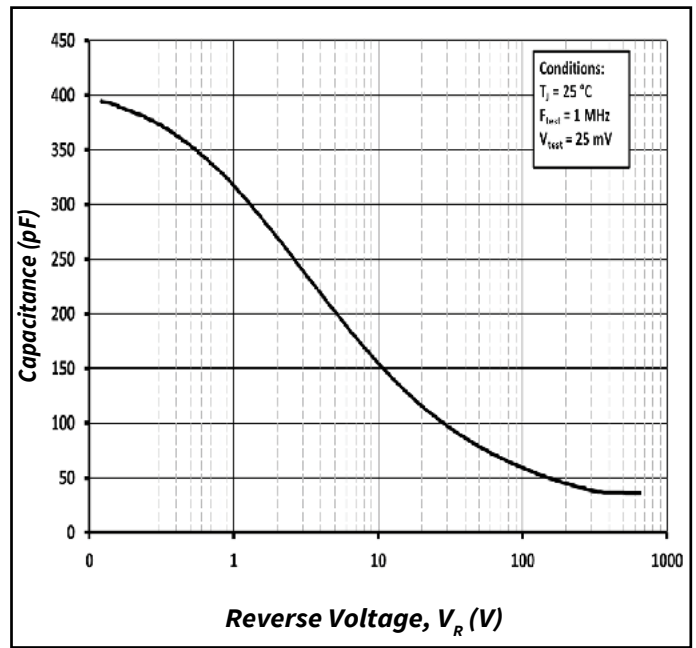

Figure 6. Capacitance vs. Reverse Voltage



Typical Performance

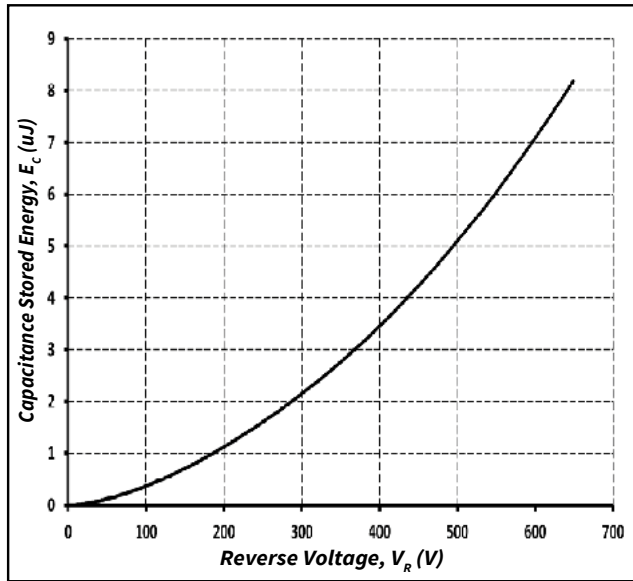

Figure 7. Capacitance Stored Energy

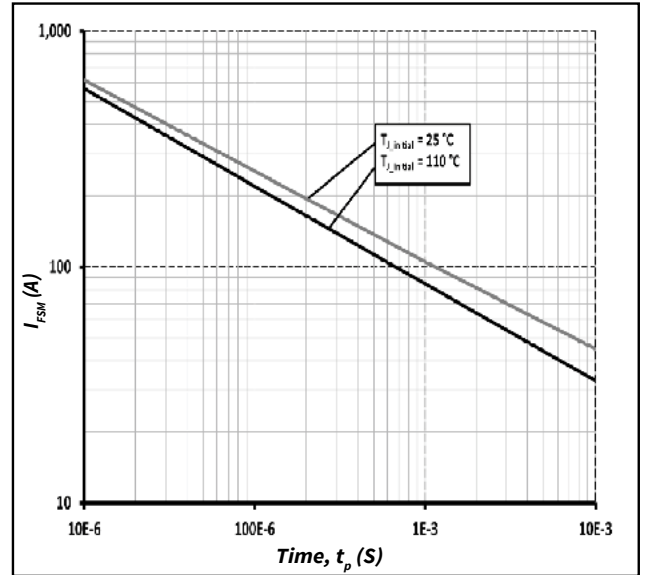

Figure 8. Non-Repetitive Peak Forward Surge Current (Sine Wave)

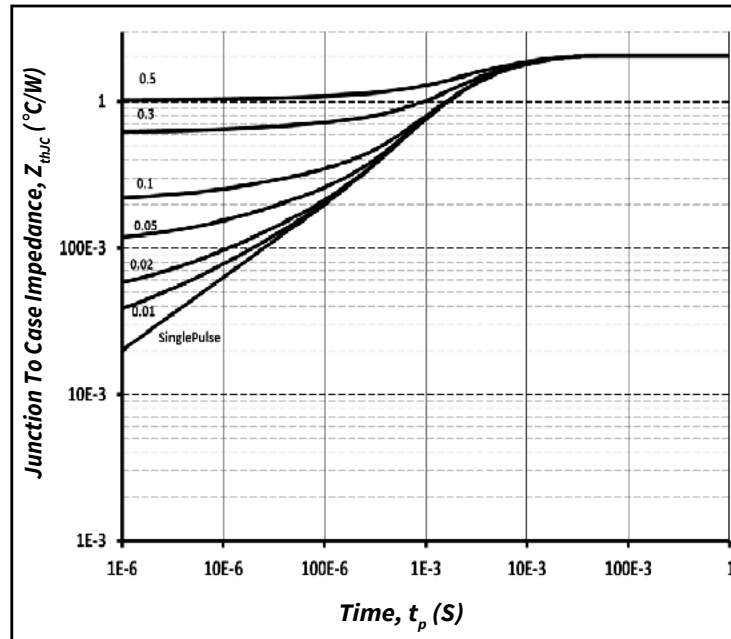
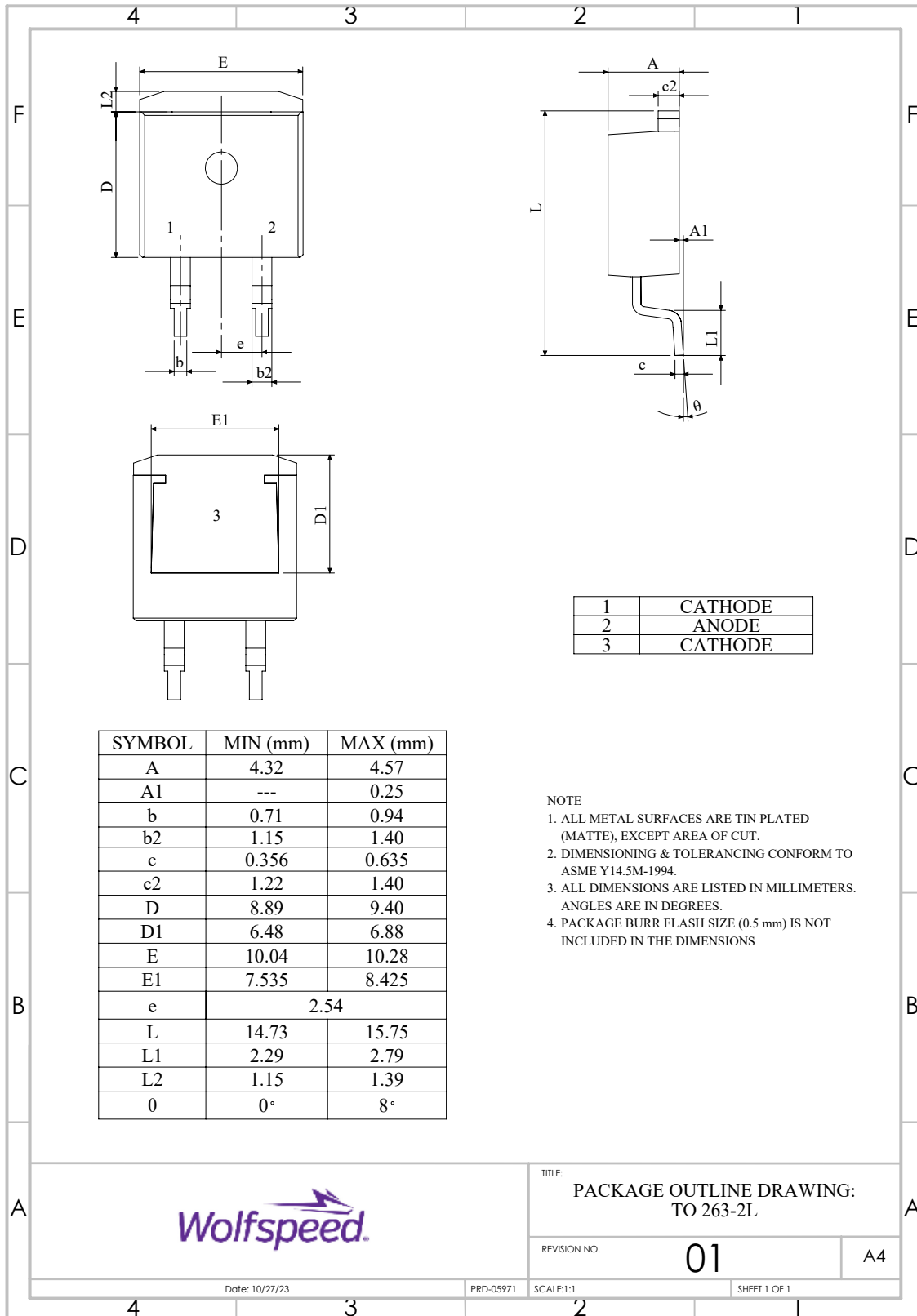

Figure 9. Transient Thermal Impedance



### Package Dimensions

Package: TO-263-2





## Recommended Solder Pad Layout

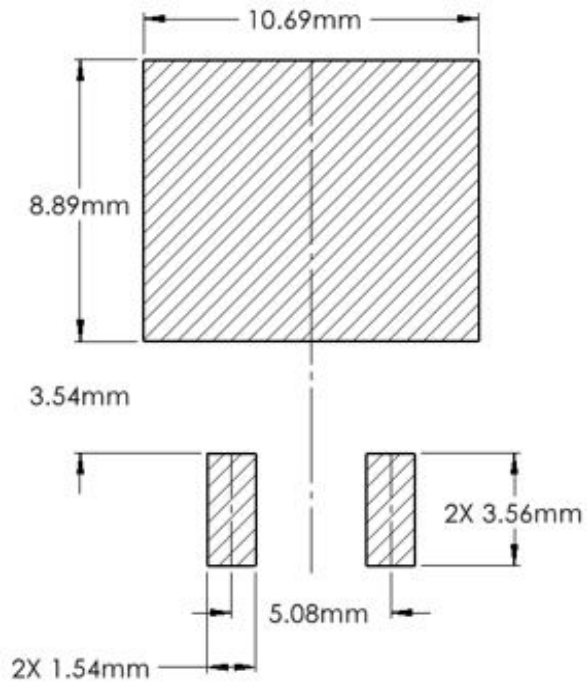

Part Number	Package	Marking
C6D06065G	TO-263-2	C6D06065

## Electrostatic Discharge (ESD) Classifications

Parameter	Symbol	Class
Human Body Model	HBM	Class 3B ( $\geq 8000$ V)
Charge Device Model	CDM	Class C3 ( $\geq 1000$ V)



## Revision History

Current Revision	Date of Release	Description of Changes
0	July-2021	Initial Release
1	October-2023	Updated Wolfspeed branding, package drawing, and solder pad layout (Not Released)
2	November-2023	Corrected Package Drawing L and L1
3	November - 2024	Legal disclaimer, Figure 2 legend corrected



## Notes & Disclaimer

---

WOLFSPPEED PROVIDES TECHNICAL AND RELIABILITY DATA, DESIGN RESOURCES, APPLICATION OR OTHER DESIGN ADVICE, WEB TOOLS, AND OTHER RESOURCES “AS IS” AND WITH ALL FAULTS, AND DISCLAIMS ALL WARRANTIES, EXPRESS AND IMPLIED, WITH RESPECT THERETO, INCLUDING WITHOUT LIMITATION ANY IMPLIED WARRANTIES OF MERCHANTABILITY, SUITABILITY, FITNESS FOR A PARTICULAR PURPOSE, OR NON-INFRINGEMENT OF THIRD-PARTY INTELLECTUAL PROPERTY RIGHTS.

This document and the information contained herein are subject to change without notice. Any such change shall be evidenced by the publication of an updated version of this document by Wolfsppeed. No communication from any employee or agent of Wolfsppeed or any third party shall effect an amendment or modification of this document. No responsibility is assumed by Wolfsppeed for any infringement of patents or other rights of third parties which may result from use of the information contained herein. No license is granted by implication or otherwise under any patent or patent rights of Wolfsppeed.

The information contained in this document (excluding examples, as well as figures or values that are labeled as “typical”) constitutes Wolfsppeed’s sole published specifications for the subject product. “Typical” parameters are the average values expected by Wolfsppeed in large quantities and are provided for informational purposes only. Any examples provided herein have not been produced under conditions intended to replicate any specific end use. Product performance can and does vary due to a number of factors.

This product has not been designed or tested for use in, and is not intended for use in, any application in which failure of the product would reasonably be expected to cause death, personal injury, or property damage. For purposes of (but without limiting) the foregoing, this product is not designed, intended, or authorized for use as a critical component in equipment implanted into the human body, life-support machines, cardiac defibrillators, and similar emergency medical equipment; air traffic control systems; or equipment used in the planning, construction, maintenance, or operation of nuclear facilities. Notwithstanding any application-specific information, guidance, assistance, or support that Wolfsppeed may provide, the buyer of this product is solely responsible for determining the suitability of this product for the buyer’s purposes, including without limitation (1) selecting the appropriate Wolfsppeed products for the buyer’s application, (2) designing, validating, and testing the buyer’s application, and (3) ensuring the buyer’s application meets applicable standards and any other legal, regulatory, and safety-related requirements.

### **RoHS Compliance**

The levels of RoHS restricted materials in this product are below the maximum concentration values (also referred to as the threshold limits) permitted for such substances, or are used in an exempted application, in accordance with EU Directive 2011/65/EC (RoHS2), as implemented January 2, 2013. RoHS Declarations for this product can be obtained from your Wolfsppeed representative or from the Product Documentation sections of [www.wolfsppeed.com](http://www.wolfsppeed.com).

### **REACH Compliance**

REACH substances of high concern (SVHCs) information is available for this product. Since the European Chemical Agency (ECHA) has published notice of their intent to frequently revise the SVHC listing for the foreseeable future, please contact your Wolfsppeed representative to ensure you get the most up-to-date REACH SVHC Declaration. REACH banned substance information (REACH Article 67) is also available upon request.

### **Contact info:**

4600 Silicon Drive  
Durham, NC 27703 USA  
Tel: +1.919.313.5300  
[www.wolfsppeed.com/power](http://www.wolfsppeed.com/power)

© 2024 Wolfsppeed, Inc. All rights reserved. Wolfsppeed® and the Wolfstreak logo are registered trademarks and the Wolfsppeed logo is a trademark of Wolfsppeed, Inc.  
PATENT: <https://www.wolfsppeed.com/legal/patents>

*The information in this document is subject to change without notice.*