

E3D30065D

650 V, 30 A Silicon Carbide Schottky Diode

Features

- 650-Volt Schottky rectifier
- Zero reverse recovery current
- Zero forward recovery voltage
- High-frequency operation
- Temperature-independent switching behavior
- Extremely fast switching
- Positive temperature coefficient on V_f



TO-247-3

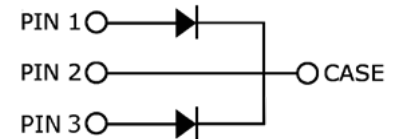

Package Types: TO-247-3

PN's: E3D30065D

WolfSpeed, Inc. is in the process of rebranding its products and related materials pursuant to the entity name change from Cree, Inc. to WolfSpeed, Inc. During this transition period, products received may be marked with either the Cree name and/or logo or the WolfSpeed name and/or logo.

Typical Applications

- Automotive and traction power conversion
- Battery charging systems
- Boost diodes in PFC or DC/DC stages
- Free wheeling diodes in inverter stages
- AC/DC converters
- PV inverters

Benefits

- Higher system level efficiency
- Increase system power density
- Reduction of heat sink requirements
- Parallel devices without thermal runaway

Maximum Ratings ($T_c = 25\text{ }^\circ\text{C}$ Unless Otherwise Specified)

Parameter	Symbol	Value	Unit	Test Conditions	Note
Repetitive Peak Reverse Voltage	V_{RRM}	650	V		
DC Peak Reverse Voltage	V_R	650			
Continuous Forward Current	I_F	42*/84**	A	$T_c = 25\text{ }^\circ\text{C}$	Fig. 3
		20*/40**		$T_c = 135\text{ }^\circ\text{C}$	
		15*/30**		$T_c = 150\text{ }^\circ\text{C}$	
Power Dissipation	P_{tot}	179*	W	$T_c = 25\text{ }^\circ\text{C}$	Fig. 4
		77*		$T_c = 110\text{ }^\circ\text{C}$	
Repetitive Peak Forward Surge Current	I_{FRM}	57*	A	$T_c = 25\text{ }^\circ\text{C}$, $t_p = 10\text{ ms}$, Half Sine Pulse	
		33*		$T_c = 110\text{ }^\circ\text{C}$, $t_p = 10\text{ ms}$, Half Sine Pulse	
Diode dV/dt Ruggedness	dV/dt	200	V/ns	$V_R = 0\text{--}650\text{ V}$	
Operating Junction and Storage Temperature	T_J, T_{stg}	-55 to +175	$^\circ\text{C}$		
TO-247 Mounting Torque		1	Nm	M3 Screw	
		8.8	lbf-in	6-32 Screw	

* Per Leg, ** Per Device



Electrical Characteristics

Parameter	Symbol	Typ.	Max.	Unit	Test Conditions	Note
Forward Voltage	V_F	1.5*	1.8*	V	$I_F = 16 \text{ A}, T_J = 25^\circ\text{C}$	Fig. 1
		2.0*	2.4*		$I_F = 16 \text{ A}, T_J = 175^\circ\text{C}$	
Reverse Current	I_R	18*	95*	μA	$V_R = 650 \text{ V}, T_J = 25^\circ\text{C}$	Fig. 2
		38*	378*		$V_R = 650 \text{ V}, T_J = 175^\circ\text{C}$	
Total Capacitive Charge	Q_C	43*		nC	$V_R = 400 \text{ V}, I_F = 16 \text{ A}, T_J = 25^\circ\text{C}$	Fig. 5
Total Capacitance	C	744*		pF	$V_R = 0 \text{ V}, T_J = 25^\circ\text{C}, f = 1 \text{ MHz}$	Fig. 6
		76*			$V_R = 200 \text{ V}, T_J = 25^\circ\text{C}, f = 1 \text{ MHz}$	
		70*			$V_R = 400 \text{ V}, T_J = 25^\circ\text{C}, f = 1 \text{ MHz}$	
Capacitance Stored Energy	E_C	7.3*		μJ	$V_R = 400 \text{ V}$	Fig. 7

Note: This is a majority carrier diode, so there is no reverse recovery charge.

Thermal Characteristics

Parameter	Symbol	Typ.	Unit	Note
Thermal Resistance from Junction to Case	$R_{\theta JC}$	0.84*	$^\circ\text{C/W}$	Fig. 8
		0.42**		

* Per Leg, ** Per Device

Typical Performance (Per Leg)

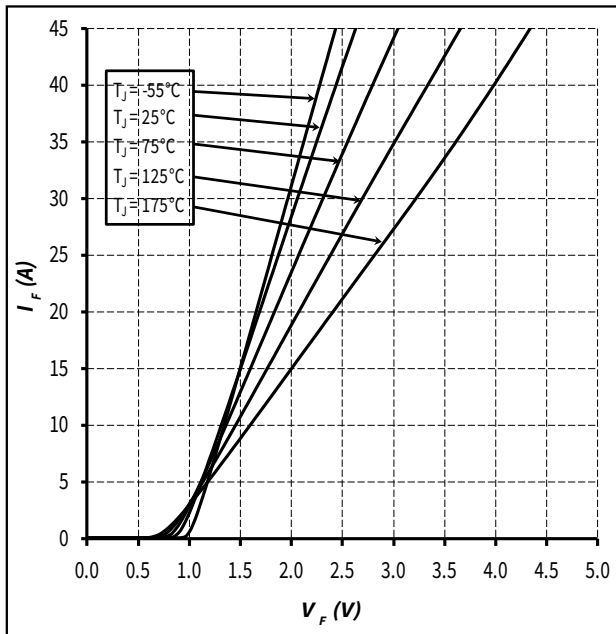

Figure 1. Forward Characteristics

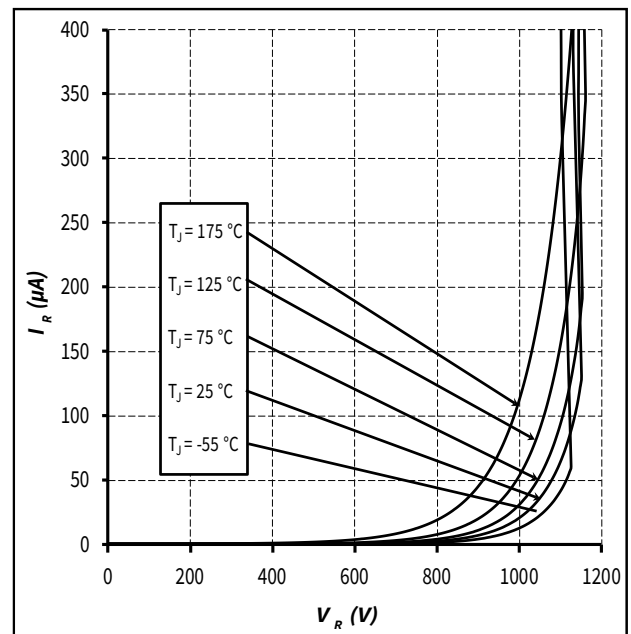

Figure 2. Reverse Characteristics



Typical Performance (Per Leg)

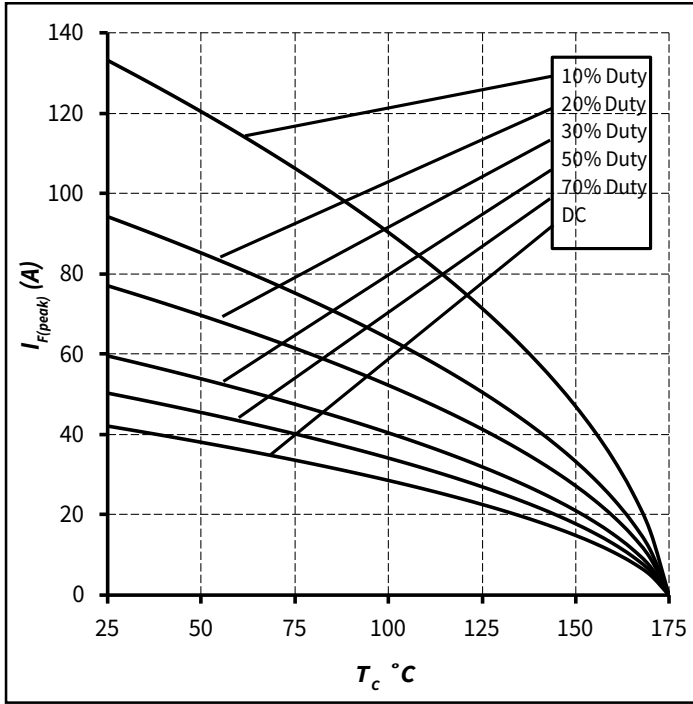

Figure 3. Current Derating

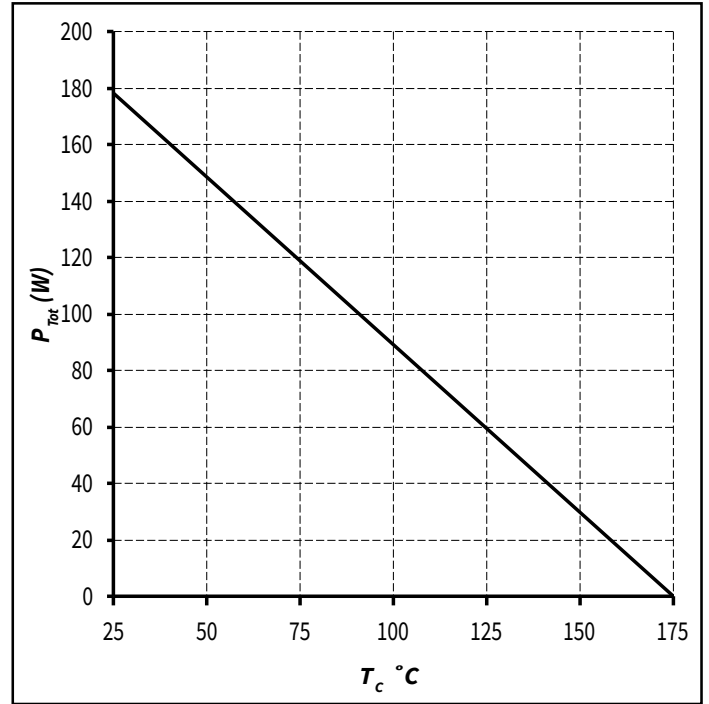

Figure 4. Power Derating

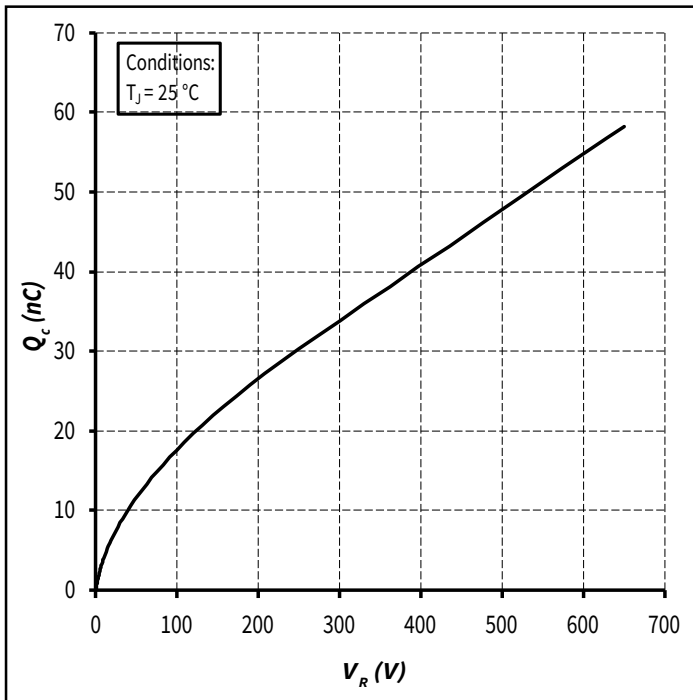

Figure 5. Recovery Charge vs. Reverse Voltage

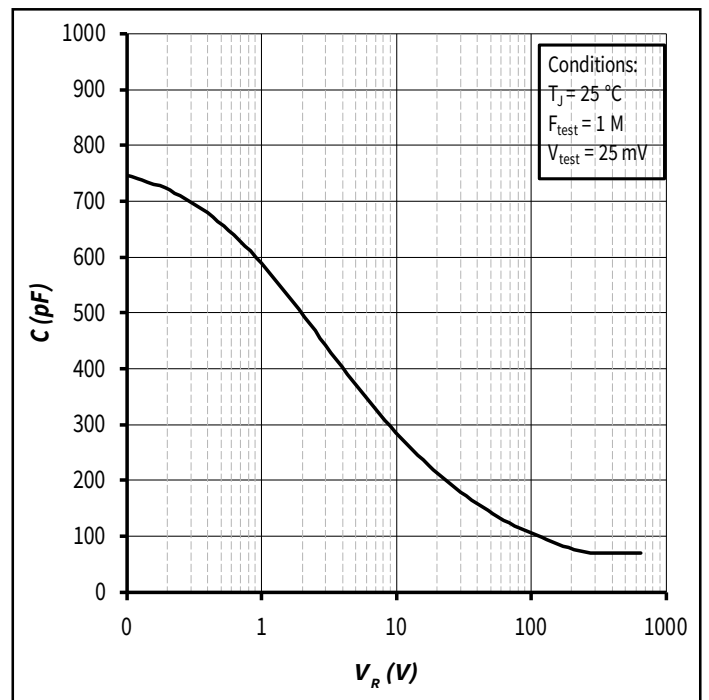

Figure 6. Capacitance vs. Reverse Voltage



Typical Performance (Per Leg)

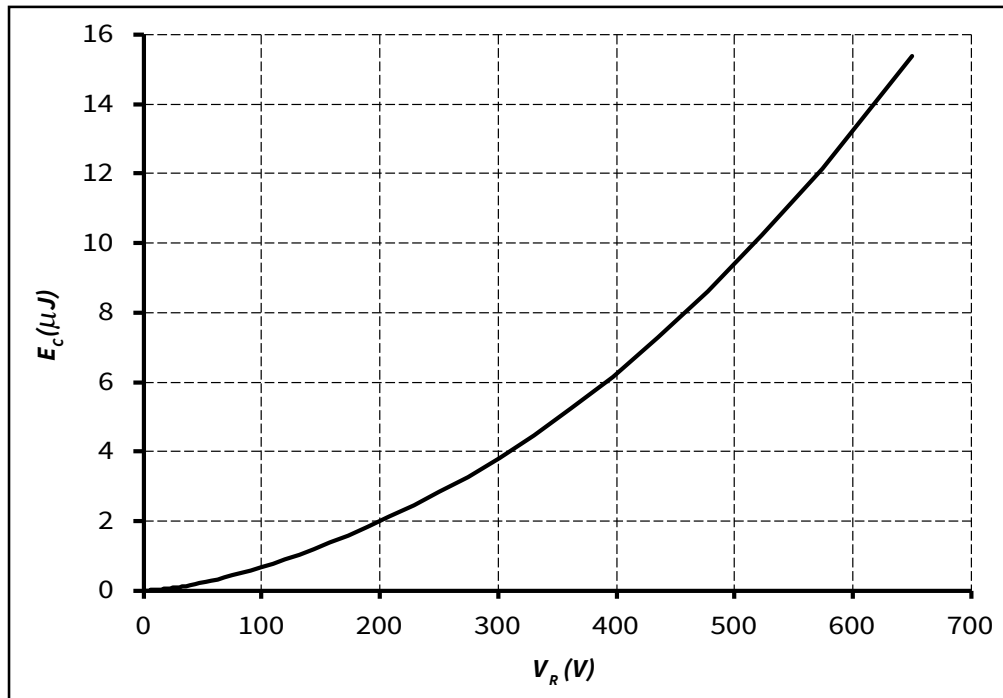

Figure 7. Typical Capacitance Stored Energy

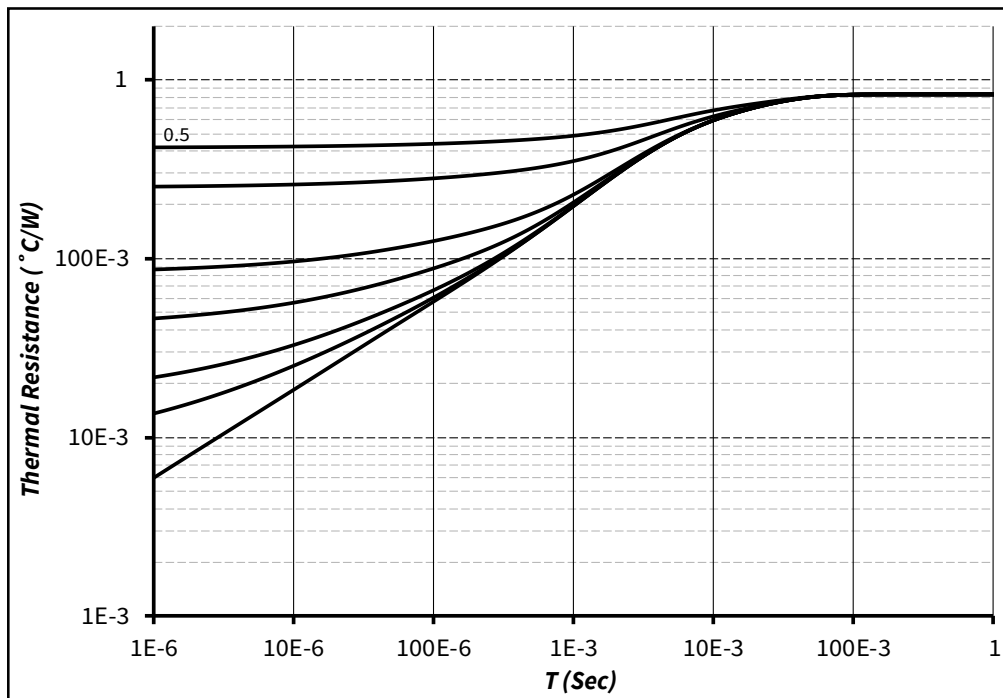
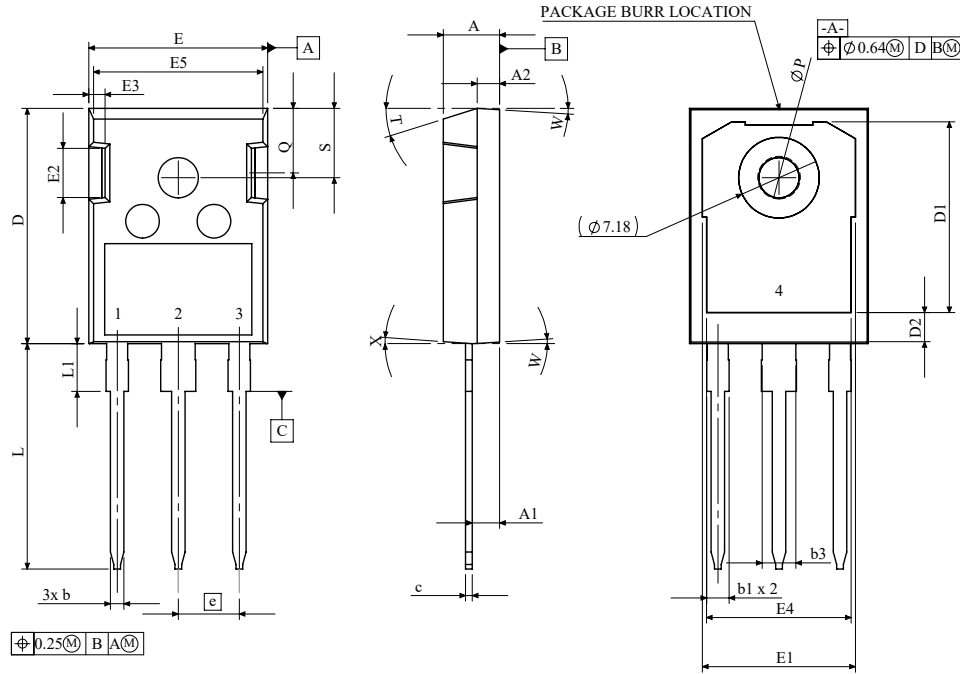

Figure 8. Transient Thermal Impedance



Package Dimensions

Package: TO-247-3



SYMBOL	MIN (mm)	MAX (mm)
A	4.83	5.21
A1	2.27	2.52
A2	1.91	2.16
b	1.07	1.33
b1	1.91	2.41
b3	2.87	3.38
c	0.55	0.74
D	20.75	21.05
D1	16	17.4
D2	2.86	3.26
E	15.75	16.13
E1	13.5	14.55
E2	3.68	5.1
E3	1	1.9
E4	12.38	13.43
E5	14.65	15.05
e	5.44 BSC	
L	19.73	20.48
L1	3.97	4.69
ϕP	3.18	4.06
Q	5.42	5.96
S	5.85	6.49
T	17.5° REF.	
W	3.5° REF.	
X	4° REF.	

1	ANODE
2	CATHODE
3	ANODE
4	CATHODE

NOTES:

1. ALL METAL SURFACES ARE TIN PLATED (MATTE), EXCEPT AREA OF CUT.
2. DIMENSIONING & TOLERANCING CONFORM TO ASME Y14.5M-1994.
3. ALL DIMENSIONS ARE LISTED IN MILLIMETERS. ANGLES ARE IN DEGREES.
4. BURR OR MOLD FLASH SIZE (0.5 mm) IS NOT INCLUDED IN THE DIMENSIONS



Recommended Solder Pad Layout

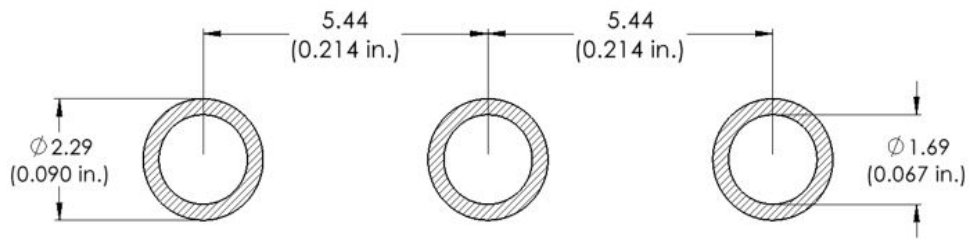

Part Number	Package	Marking
E3D30065D	TO-247-3	E3D30065



Revision History

Current Revision	Date of Release	Description of Changes
1	September-2023	Updated Wolfspeed branding, package drawing, and solder pad layout
2	February 2025	Legal Disclaimer and POD



Notes & Disclaimer

WOLFSPEED PROVIDES TECHNICAL AND RELIABILITY DATA, DESIGN RESOURCES, APPLICATION OR OTHER DESIGN ADVICE, WEB TOOLS, AND OTHER RESOURCES “AS IS” AND WITH ALL FAULTS, AND DISCLAIMS ALL WARRANTIES, EXPRESS AND IMPLIED, WITH RESPECT THERETO, INCLUDING WITHOUT LIMITATION ANY IMPLIED WARRANTIES OF MERCHANTABILITY, SUITABILITY, FITNESS FOR A PARTICULAR PURPOSE, OR NON-INFRINGEMENT OF THIRD-PARTY INTELLECTUAL PROPERTY RIGHTS.

This document and the information contained herein are subject to change without notice. Any such change shall be evidenced by the publication of an updated version of this document by Wolfspeed. No communication from any employee or agent of Wolfspeed or any third party shall effect an amendment or modification of this document. No responsibility is assumed by Wolfspeed for any infringement of patents or other rights of third parties which may result from use of the information contained herein. No license is granted by implication or otherwise under any patent or patent rights of Wolfspeed.

The information contained in this document (excluding examples, as well as figures or values that are labeled as “typical”) constitutes Wolfspeed’s sole published specifications for the subject product. “Typical” parameters are the average values expected by Wolfspeed in large quantities and are provided for informational purposes only. Any examples provided herein have not been produced under conditions intended to replicate any specific end use. Product performance can and does vary due to a number of factors.

This product has not been designed or tested for use in, and is not intended for use in, any application in which failure of the product would reasonably be expected to cause death, personal injury, or property damage. For purposes of (but without limiting) the foregoing, this product is not designed, intended, or authorized for use as a critical component in equipment implanted into the human body, life-support machines, cardiac defibrillators, and similar emergency medical equipment; air traffic control systems; or equipment used in the planning, construction, maintenance, or operation of nuclear facilities. Notwithstanding any application-specific information, guidance, assistance, or support that Wolfspeed may provide, the buyer of this product is solely responsible for determining the suitability of this product for the buyer’s purposes, including without limitation (1) selecting the appropriate Wolfspeed products for the buyer’s application, (2) designing, validating, and testing the buyer’s application, and (3) ensuring the buyer’s application meets applicable standards and any other legal, regulatory, and safety-related requirements.

RoHS Compliance

The levels of RoHS restricted materials in this product are below the maximum concentration values (also referred to as the threshold limits) permitted for such substances, or are used in an exempted application, in accordance with EU Directive 2011/65/EC (RoHS2), as implemented January 2, 2013. RoHS Declarations for this product can be obtained from your Wolfspeed representative or from the Product Documentation sections of www.wolfspeed.com.

REACH Compliance

REACH substances of high concern (SVHCs) information is available for this product. Since the European Chemical Agency (ECHA) has published notice of their intent to frequently revise the SVHC listing for the foreseeable future, please contact your Wolfspeed representative to ensure you get the most up-to-date REACH SVHC Declaration. REACH banned substance information (REACH Article 67) is also available upon request.

Contact info:

4600 Silicon Drive
Durham, NC 27703 USA
Tel: +1.919.313.5300
www.wolfspeed.com/power

© 2025 Wolfspeed, Inc. All rights reserved. Wolfspeed® and the Wolfstreak logo are registered trademarks and the Wolfspeed logo is a trademark of Wolfspeed, Inc.
PATENT: <https://www.wolfspeed.com/legal/patents>

The information in this document is subject to change without notice.