

CAB450M12XM3

1200 V, 2.6 mΩ, Silicon Carbide, Half-Bridge Module

V_{DS}	1200 V
I_{DS}	450 A

Technical Features

- High Power Density Footprint
- High Junction Temperature (175 °C) Operation
- Low-Inductance (6.7 nH) Design
- Implements Conduction-Optimized Third Generation SiC MOSFET Technology
- Silicon Nitride Insulator and Copper Baseplate
- 1200 V Drain-Source Voltage

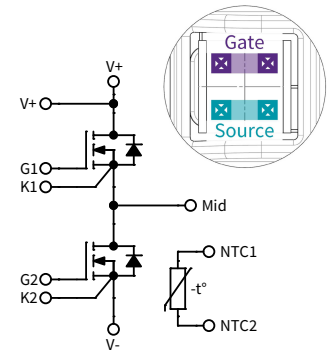

Applications

- Motor & Motion Control
- Vehicle Fast Chargers
- Uninterruptible Power Supplies
- Smart-Grid / Grid-Tied Distributed Generation
- Traction Drives
- E-mobility

System Benefits

- Terminal layout allows for direct bus bar connection without bends or bushings enabling a simple, low inductance design.
- Isolated, integrated temperature sensing enables high-level temperature protection.
- Dedicated high-side Kelvin-drain pin enables direct voltage sensing for gate driver overcurrent protection.

Key Parameters

Parameter	Symbol	Min.	Typ.	Max.	Unit	Conditions	Notes
Drain-Source Voltage	V_{DS}			1200		$T_c = 25\text{ °C}$	
Maximum Gate-Source Voltage	$V_{GS\ max}$	-8		+19	V	Transient	Fig. 33 Note 1
Operational Gate-Source Voltage	$V_{GS\ op}$		-4/-15			Static	
DC Continuous Drain Current ($T_{vj} \leq 175\text{ °C}$)	I_D			450	A	$V_{GS} = 15\text{ V}, T_c = 25\text{ °C}, T_{vj} \leq 175\text{ °C}$	Notes 2, 3, 4 Fig. 20
				438		$V_{GS} = 15\text{ V}, T_c = 90\text{ °C}, T_{vj} \leq 175\text{ °C}$	
Pulsed Drain Current	I_{DM}		900			t_{pmax} limited by $T_{j\ max}$ $V_{GS} = 15\text{ V}, T_c = 25\text{ °C}$	
Power Disipation	P_D		1670		W	$T_c = 25\text{ °C}, T_{vj} \leq 175\text{ °C}$	Note 5 Fig. 21
Operation Virtual Junction Temperature	$T_{vj\ op}$	-40		175	°C		

Note (1): recommended turn-on gate voltage is 15V with ±5% regulation tolerance

Note (2): Current limit $T_c = 25\text{ °C}$ imposed by package

Note (3): Current Limit $T_c = 90\text{ °C}$ calculated by $I_{D(max)} = \sqrt{(P_D / R_{DS(typ)}(T_{vj(max)}, I_{D(max)}))}$

Note (4): Verified by design

Note (5): $P_D = (T_{vj} - T_c) / R_{TH(jc, typ)}$



MOSFET Characteristics (Per Position) ($T_{VJ} = 25\text{ }^{\circ}\text{C}$ unless otherwise specified)

Parameter	Symbol	Min.	Typ.	Max.	Unit	Conditions	Notes
Drain-Source Breakdown Voltage	$V_{(BR)DSS}$	1200				$V_{GS} = 0\text{ V}$, $T_{VJ} = -40\text{ }^{\circ}\text{C}$	
Gate Threshold Voltage	$V_{GS(th)}$	1.8	2.5	3.6	V	$V_{DS} = V_{GS}$, $I_{DS} = 132\text{ mA}$	
			2.0			$V_{DS} = V_{GS}$, $I_{DS} = 132\text{ mA}$, $T_{VJ} = 175\text{ }^{\circ}\text{C}$	
Zero Gate Voltage Drain Current	I_{DSS}		5	200	μA	$V_{GS} = 0\text{ V}$, $V_{DS} = 1200\text{ V}$	
Gate-Source Leakage Current	I_{GSS}		50	1300	nA	$V_{GS} = 15\text{ V}$, $V_{DS} = 0\text{ V}$	
Drain-Source On-State Resistance (MOSFET Only)	$R_{DS(on)}$		2.6	3.4	m Ω	$V_{GS} = 15\text{ V}$, $I_D = 450\text{ A}$	Fig. 2
			4.7			$V_{GS} = 15\text{ V}$, $I_D = 450\text{ A}$, $T_{VJ} = 175\text{ }^{\circ}\text{C}$	Fig. 3
Transconductance	g_{fs}		355		S	$V_{DS} = 20\text{ V}$, $I_D = 450\text{ A}$	Fig. 4
			360			$V_{DS} = 20\text{ V}$, $I_D = 450\text{ A}$, $T_{VJ} = 175\text{ }^{\circ}\text{C}$	
Turn-On Switching Energy, $T_{VJ} = 25\text{ }^{\circ}\text{C}$ $T_{VJ} = 125\text{ }^{\circ}\text{C}$ $T_{VJ} = 175\text{ }^{\circ}\text{C}$	E_{On}		25.4 24.0 24.4		mJ	$V_{DD} = 600\text{ V}$, $I_D = 450\text{ A}$, $V_{GS} = -4\text{ V}/15\text{ V}$, $R_{G-ON(ext)} = 4.0\text{ }\Omega$, $R_{G-OFF(ext)} = 0.0\text{ }\Omega$, $L_G = 10.2\text{ nH}$	Fig. 11 Fig. 13
Turn-Off Switching Energy, $T_{VJ} = 25\text{ }^{\circ}\text{C}$ $T_{VJ} = 125\text{ }^{\circ}\text{C}$ $T_{VJ} = 175\text{ }^{\circ}\text{C}$	E_{Off}		7.51 8.10 8.35				
Internal Gate Resistance	$R_{G(int)}$		2.5		Ω	$f = 100\text{ kHz}$, $V_{AC} = 25\text{ mV}$	
Input Capacitance	C_{iss}		38.0		nF	$V_{GS} = 0\text{ V}$, $V_{DS} = 800\text{ V}$, $V_{AC} = 25\text{ mV}$, $f = 100\text{ kHz}$	Fig. 9
Output Capacitance	C_{oss}		1.5				
Reverse Transfer Capacitance	C_{rss}		35				
Gate to Source Charge	Q_{GS}		385		nC	$V_{DS} = 800\text{ V}$, $V_{GS} = -4\text{ V}/15\text{ V}$, $I_D = 450\text{ A}$, Per IEC60747-8-4 pg 21	
Gate to Drain Charge	Q_{GD}		475				
Total Gate Charge	Q_G		1300				
FET Thermal Resistance, Junction to Case	$R_{th\text{ JC}}$		0.094		$^{\circ}\text{C}/\text{W}$		Fig. 17

Diode Characteristics (Per Position) ($T_{VJ} = 25\text{ }^{\circ}\text{C}$ unless otherwise specified)

Parameter	Symbol	Min.	Typ.	Max.	Unit	Conditions	Notes
Body Diode Forward Voltage	V_{SD}		4.7		V	$V_{GS} = -4\text{ V}$, $I_{SD} = 450\text{ A}$	Fig. 7
			4.2			$V_{GS} = -4\text{ V}$, $I_{SD} = 450\text{ A}$, $T_{VJ} = 175\text{ }^{\circ}\text{C}$	
Reverse Recovery Time	t_{RR}		78		ns	$V_{GS} = -4\text{ V}$, $I_{SD} = 450\text{ A}$, $V_R = 600\text{ V}$, $di/dt = 5.1\text{ A/ns}$, $R_{G-ON(ext)} = 4.0\text{ }\Omega$, $T_{VJ} = 175\text{ }^{\circ}\text{C}$	
Reverse Recovery Charge	Q_{RR}		7.2		μC		
Peak Reverse Recovery Current	I_{RRM}		169		A		
Reverse Recovery Energy, $T_{VJ} = 25\text{ }^{\circ}\text{C}$ $T_{VJ} = 125\text{ }^{\circ}\text{C}$ $T_{VJ} = 175\text{ }^{\circ}\text{C}$	E_{RR}		0.2 0.9 1.1		mJ	$V_{DD} = 600\text{ V}$, $I_D = 450\text{ A}$, $V_{GS} = -4\text{ V}/15\text{ V}$, $R_{G-ON(ext)} = 4.0\text{ }\Omega$, $L_G = 10.2\text{ nH}$	Fig. 14



Temperature Sensor (NTC) Characteristics

Parameter	Symbol	Min.	Typ.	Max.	Unit	Conditions
Resistance at 25°C	R ₂₅		4700		Ω	T _{NTC} = 25 °C
Tolerance of R ₂₅				±1	%	
Beta Value for 25 °C to 85 °C	B _{25/85}		3435		K	
Beta Value for 0 °C to 100 °C	B _{0/100}		3399		K	
Tolerance of B _{25/85}				±1	%	
Maximum Power Dissipation	P ₂₅			50	mW	

Steinhart & Hart Coefficients for NTC Resistance & NTC Temperature Computation (T in K)

$$\ln\left(\frac{R}{R_{25}}\right) = A + \frac{B}{T} + \frac{C}{T^2} + \frac{D}{T^3}$$

$$\frac{1}{T} = A_1 + B_1 \ln\left(\frac{R}{R_{25}}\right) + C_1 \ln^2\left(\frac{R}{R_{25}}\right) + D_1 \ln^3\left(\frac{R}{R_{25}}\right)$$

A	B	C	D
-1.289E+01	4.245E+03	-8.749E+04	-9.588E+06

A ₁	B ₁	C ₁	D ₁
3.354E-03	3.001E-04	5.085E-06	2.188E-07

Module Physical Characteristics

Parameter	Symbol	Min.	Typ.	Max.	Unit	Conditions
Package Resistance, M1 (High-Side)	R ₃₋₁		0.72		mΩ	T _C = 125 °C, Note 6 & 7
Package Resistance, M2 (Low-Side)	R ₁₋₂		0.63			T _C = 125 °C, Note 6 & 7
Stray Inductance	L _{Stray}		6.7		nH	Between terminals 2 & 3, f = 10 MHz
Case Temperature	T _C	-40		125	°C	
Mounting Torque	M _S	2.0	3.0	4.0	N-m	Baseplate, M4 bolts
		2.0	4.0	5.0		Power Terminals, M5 bolts
Weight	W		175		g	
Case Isolation Voltage	V _{isol}	4.0			kV	AC, 50 Hz, 1 minute
Comparative Tracking Index	CTI	600				
Clearance Distance		12.5			mm	From 2 to 3, Note 7
		11.5				From 1 to Baseplate, Note 7
		5.7				From 2 to 5, Note 7
		13.7				From 5 to Baseplate, Note 7
Creepage Distance		14.7				From 2 to 3, Note 7
		14.0				From 1 to Baseplate, Note 7
		14.7				From 2 to 5, Note 7
		14.3				From 5 to Baseplate, Note 7

Note (6): Total Effective Resistance (Per Switch Position) = MOSFET R_{DS(ON)} + Switch Position Package Resistance

Note (7): Numbers reference the connections from the Schematics and Pin Out section of this document



Typical Performance

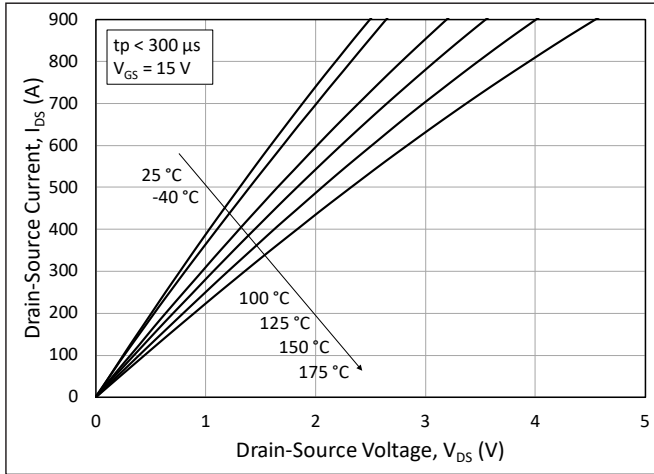

Figure 1. Output Characteristics for Various Junction Temperatures

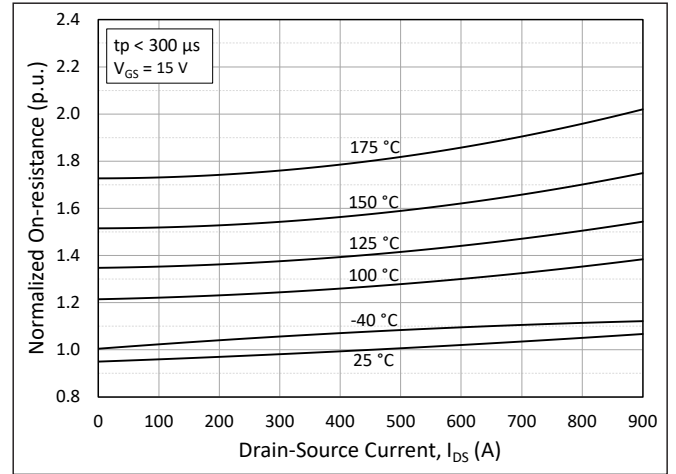

Figure 2. Normalized On-State Resistance vs. Drain Current for Various Junction Temperatures

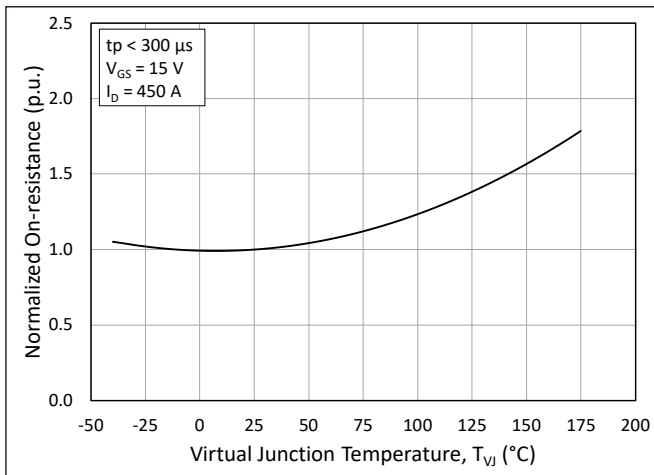

Figure 3. Normalized On-State Resistance vs. Junction Temperature

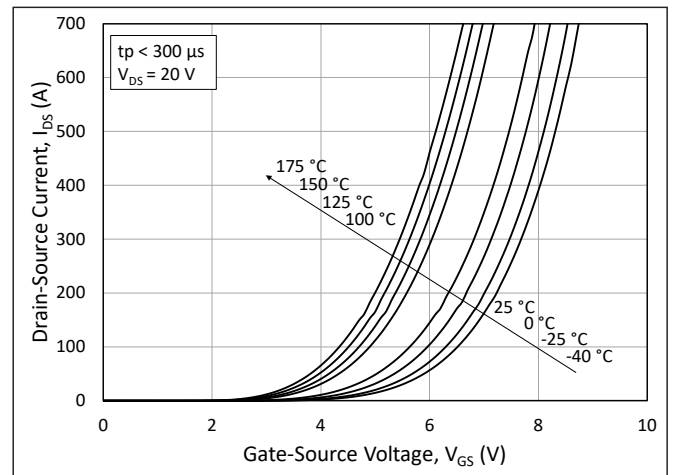

Figure 4. Transfer Characteristic for Various Junction Temperatures

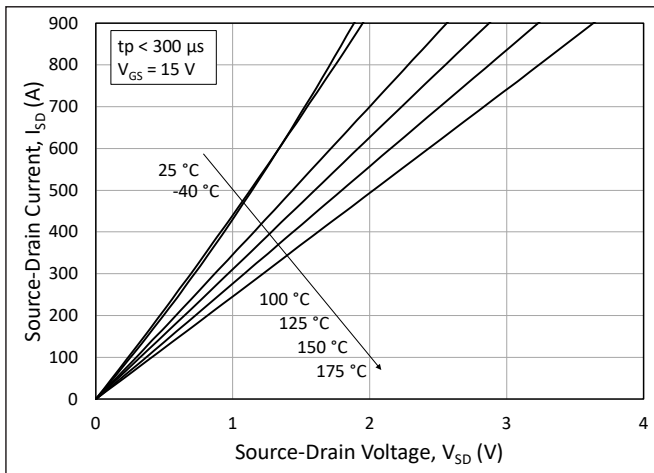

Figure 5. 3rd Quadrant Characteristic vs. Junction Temperatures at $V_{GS} = 15\text{ V}$

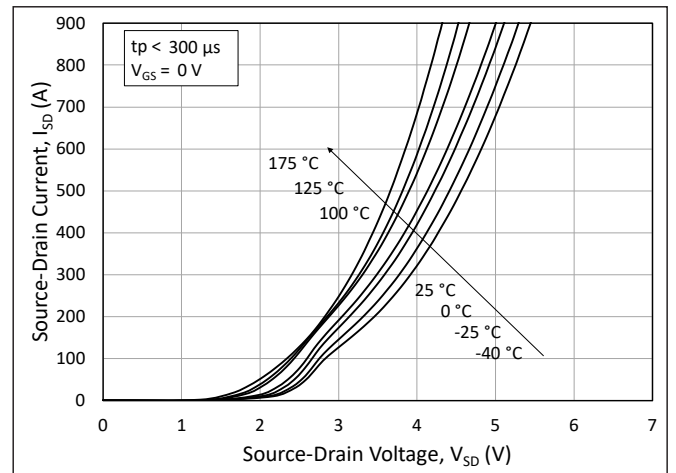

Figure 6. 3rd Quadrant Characteristic vs. Junction Temperatures at $V_{GS} = 0\text{ V}$



Typical Performance

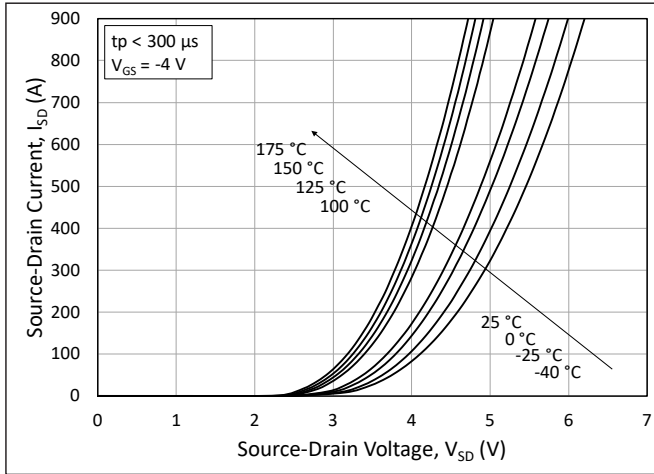

Figure 7. 3rd Quadrant Characteristic vs. Junction Temperatures at $V_{GS} = -4$ V (Body Diode)

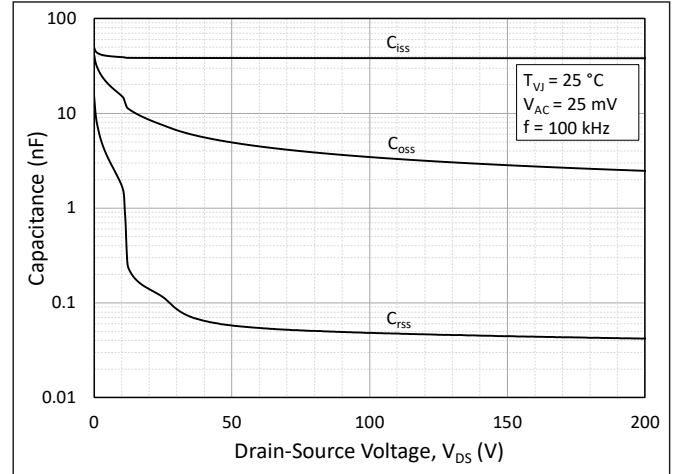

Figure 8. Typical Capacitances vs. Drain to Source Voltage (0 - 200 V)

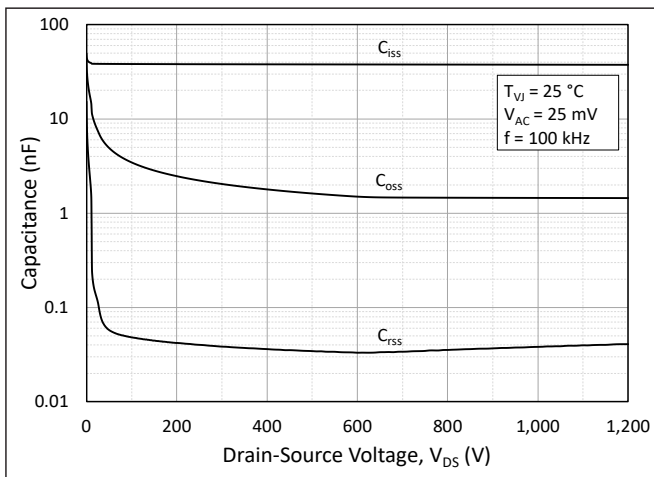

Figure 9. Typical Capacitances vs. Drain to Source Voltage (0 - 1200 V)

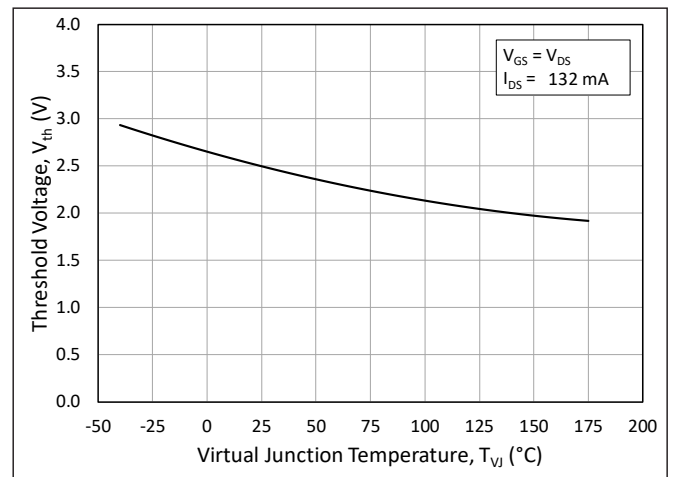

Figure 10. Threshold Voltage vs. Junction Temperature

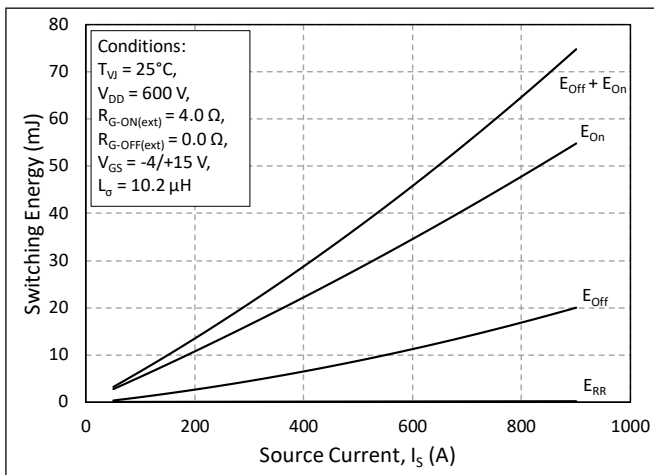

Figure 11. Switching Energy vs. Drain Current ($V_{DD} = 600$ V)

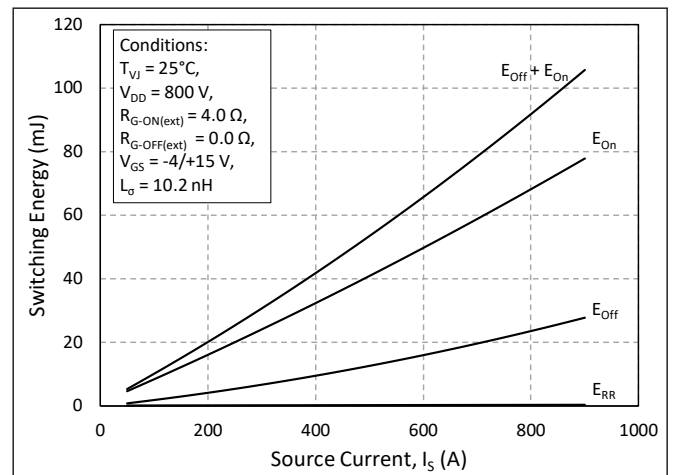

Figure 12. Switching Energy vs. Drain Current ($V_{DD} = 800$ V)



Typical Performance

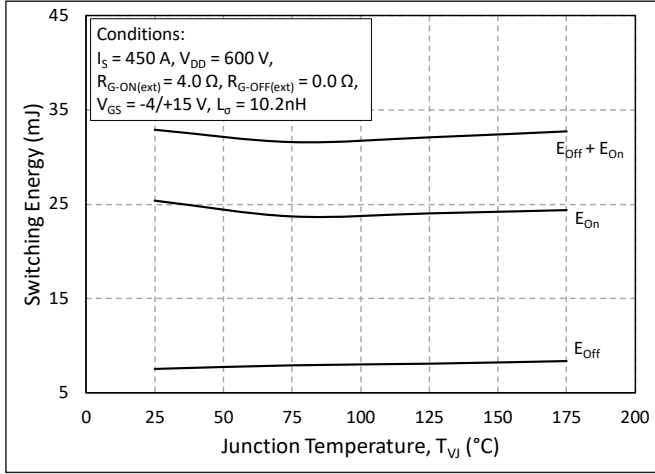

Figure 13. MOSFET Switching Energy vs. Junction Temperature

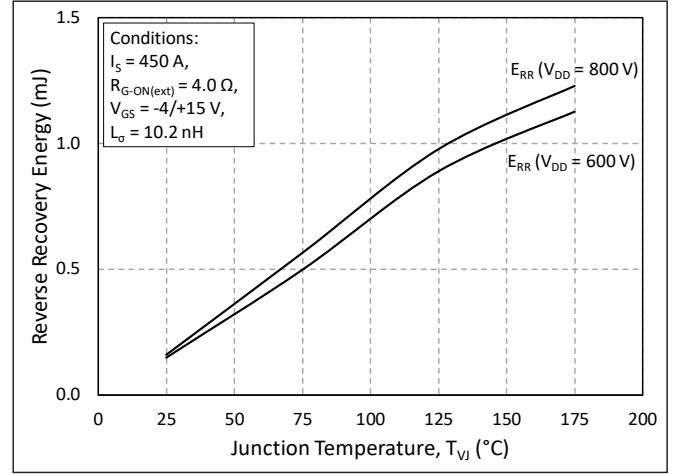

Figure 14. Reverse Recovery Energy vs. Junction Temperature

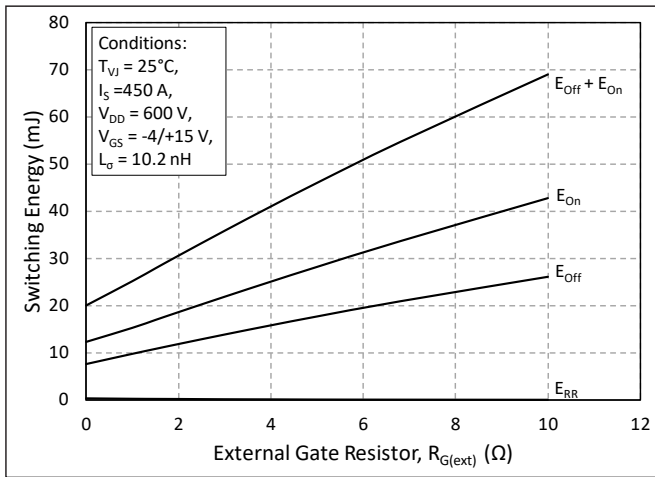

Figure 15. MOSFET Switching Energy vs. External Gate Resistance

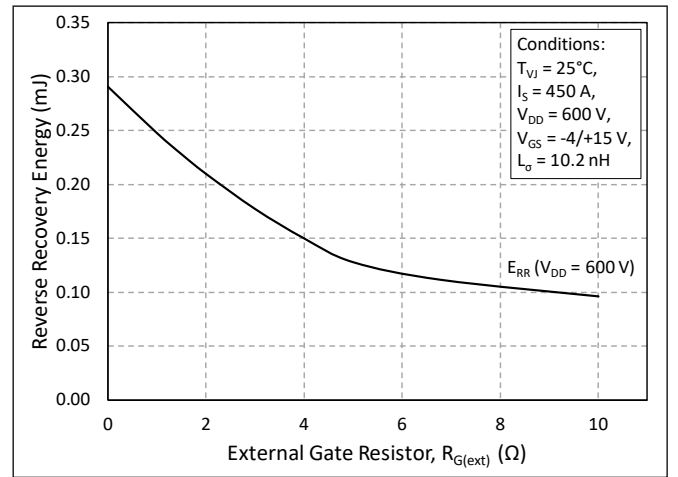

Figure 16. Reverse Recovery Energy vs. External Gate Resistance

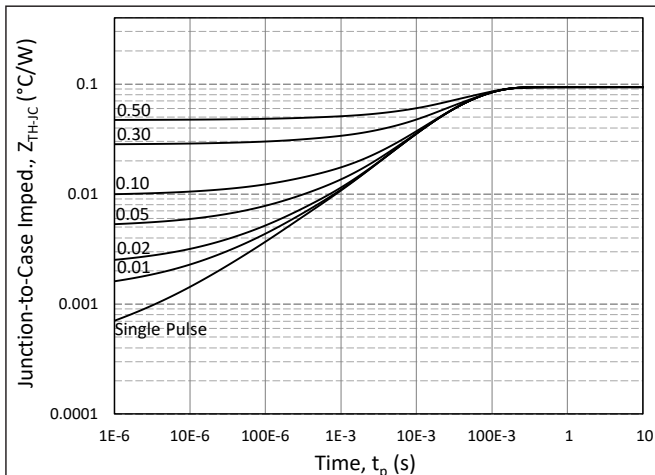

Figure 17. MOSFET Junction to Case Transient Thermal Impedance, Z_{thJC} (°C/W)

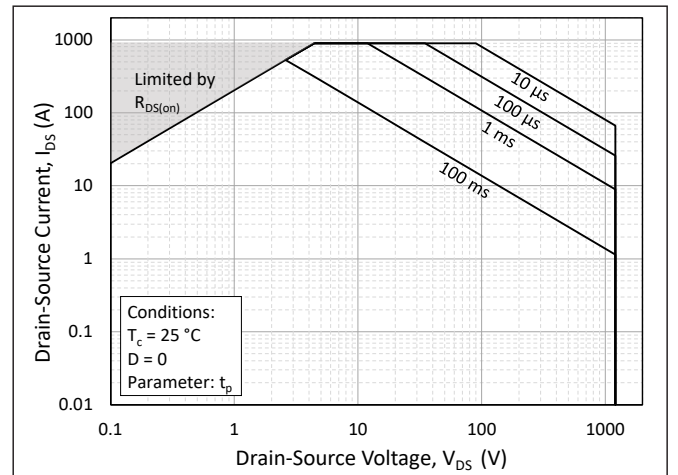

Figure 18. Forward Bias Safe Operating Area (FBSOA)



Typical Performance

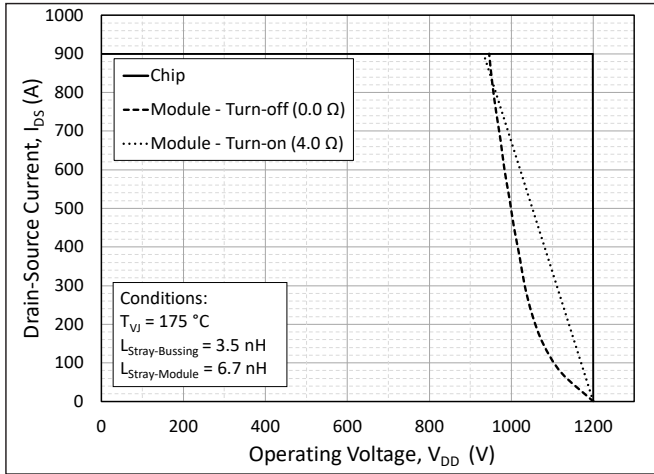

Figure 19. Switching Safe Operating Area

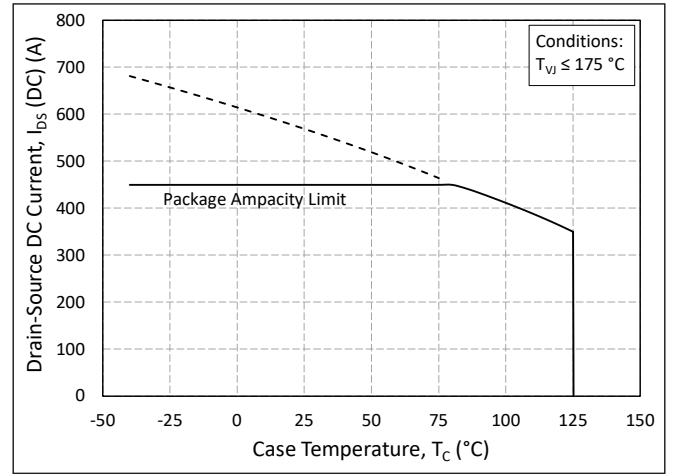

Figure 20. Continuous Drain Current Derating vs. Case Temperature

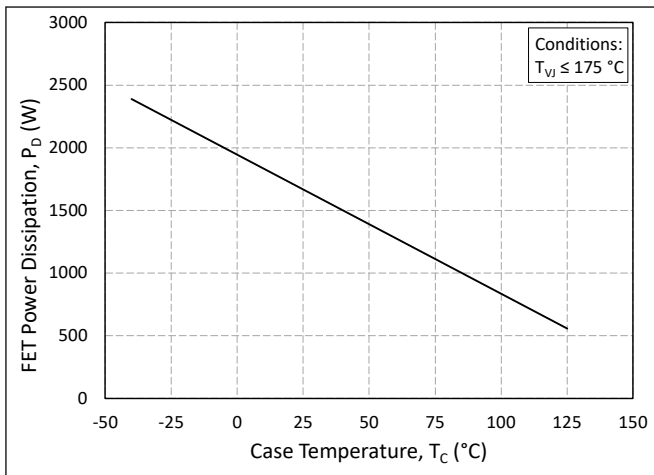

Figure 21. Maximum Power Dissipation Derating vs. Case Temperature

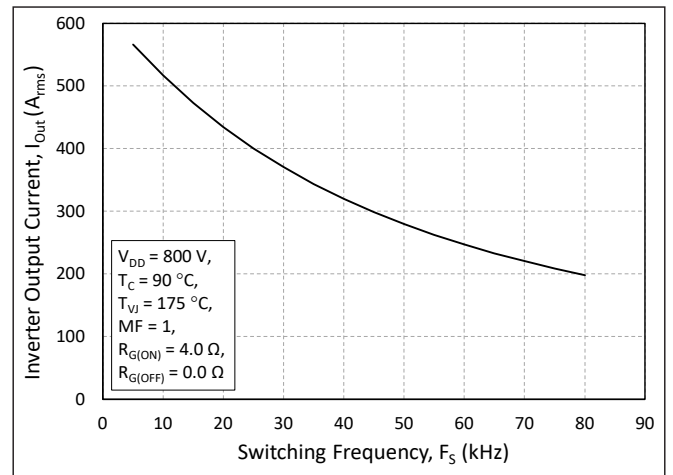

Figure 22. Typical Output Current Capability vs. Switching Frequency (Inverter Application)

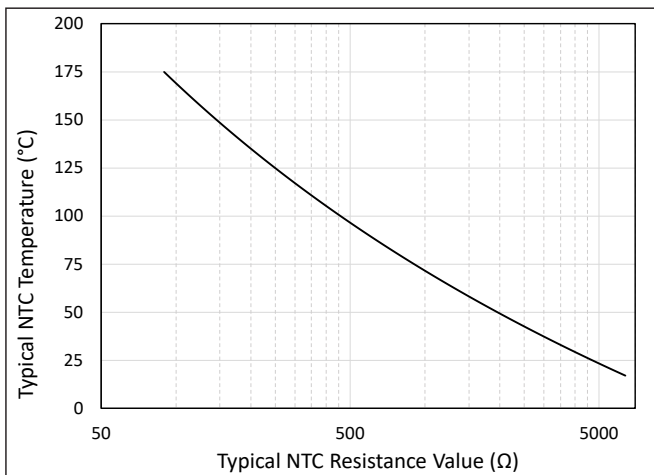

Figure 23. NTC Resistance vs. NTC Temperature



Timing Characteristics

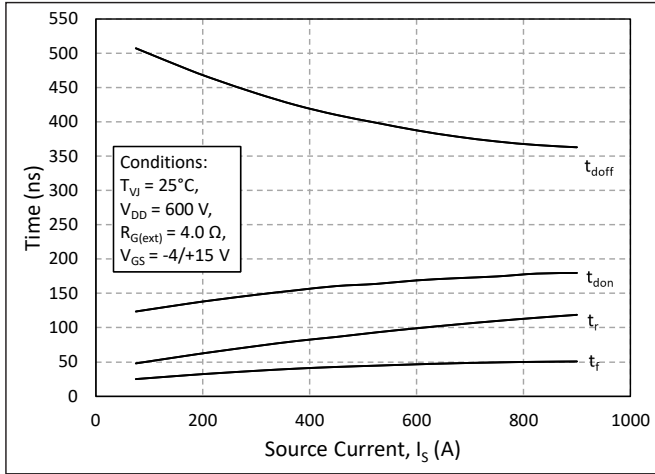

Figure 24. Timing vs. Source Current

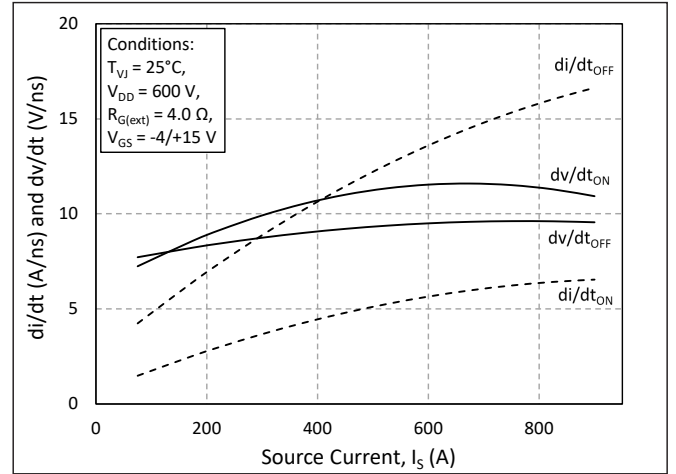

Figure 25. dv/dt and di/dt vs. Source Current

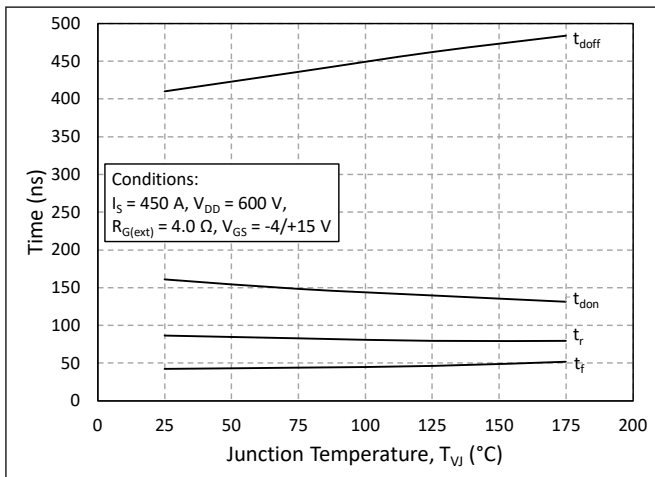

Figure 26. Timing vs. Junction Temperature

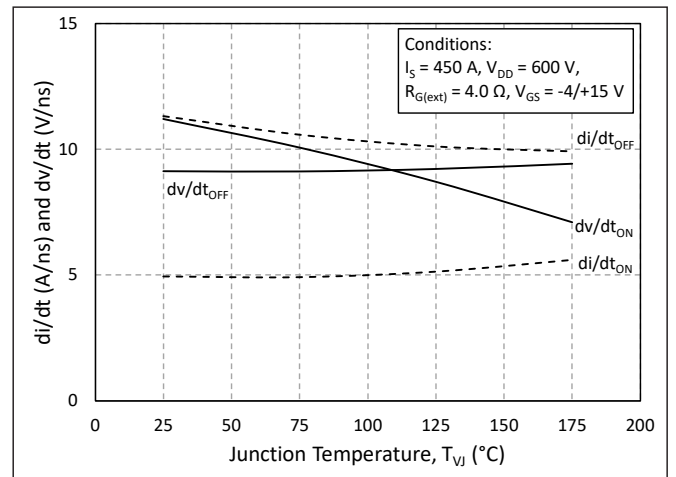

Figure 27. dv/dt and di/dt vs. Junction Temperature

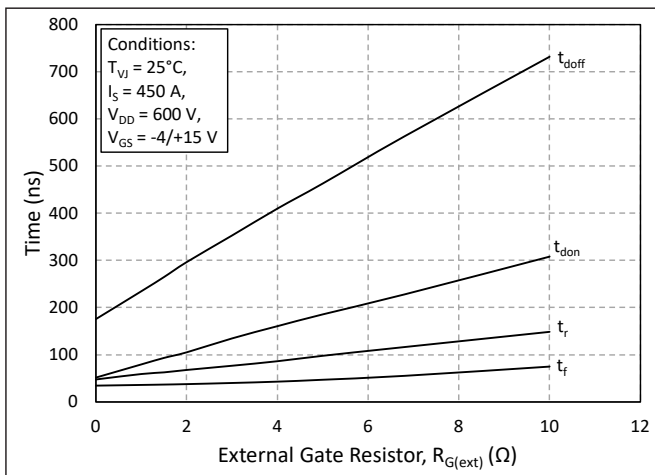

Figure 28. Timing vs. External Gate Resistance

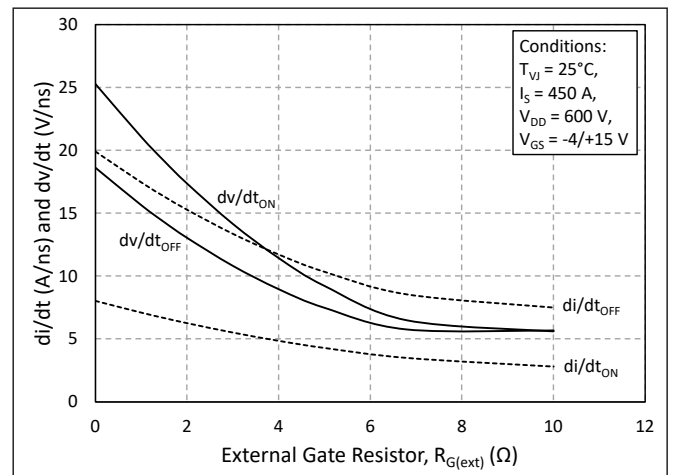

Figure 29. dv/dt and di/dt vs. External Gate Resistance



Definitions

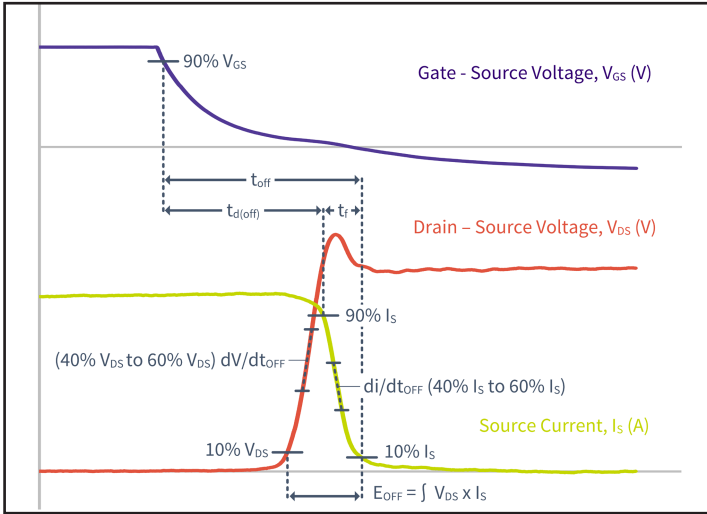

Figure 30. Turn-off Transient Definitions

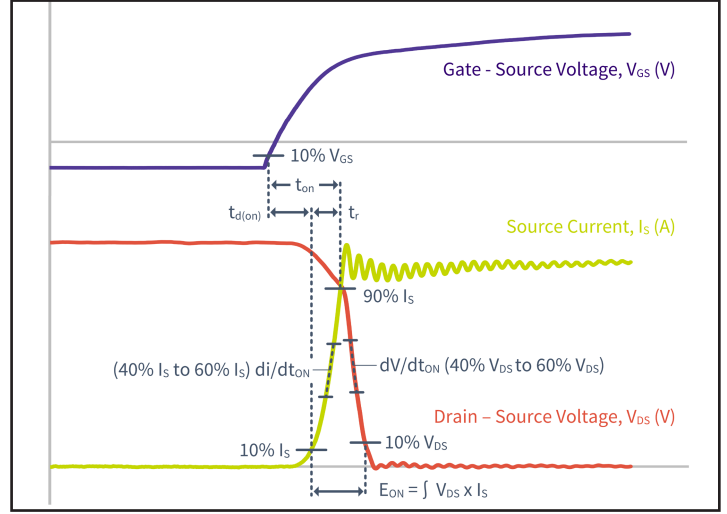

Figure 31. Turn-on Transient Definitions

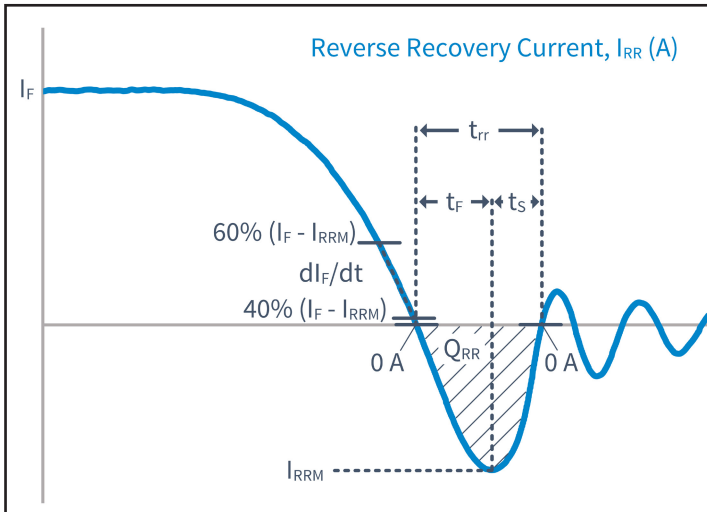

Figure 32. Reverse Recovery Definitions

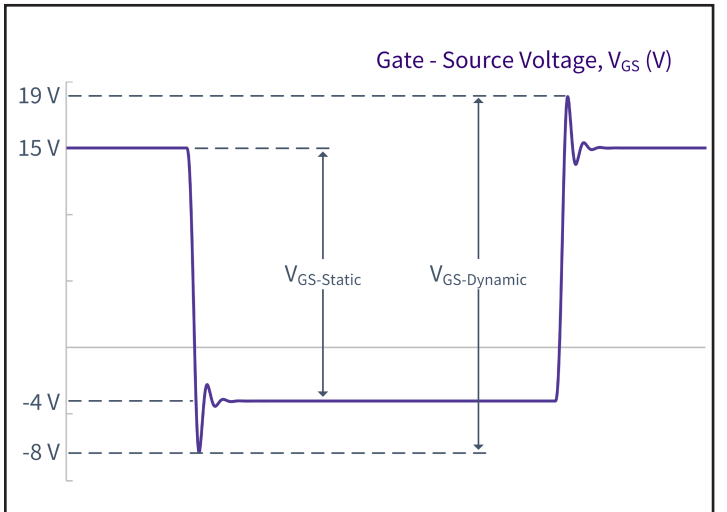
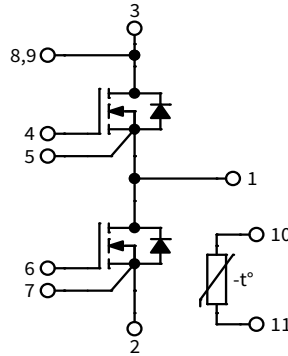
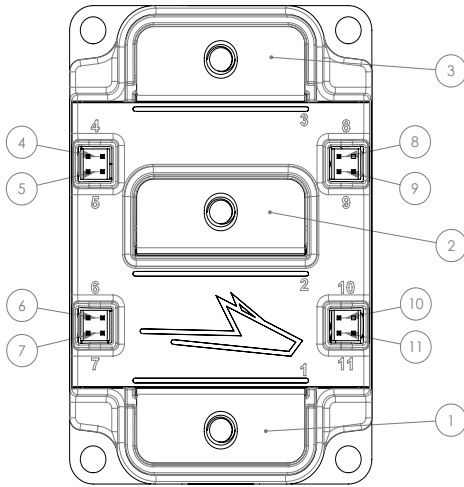

Figure 33. V_{GS} Transient Definitions



Schematic and Pinout



Zoom View of Signal Pinout

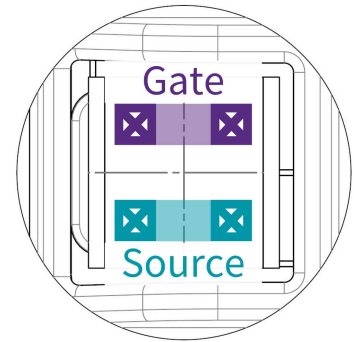

Package Dimension (mm)

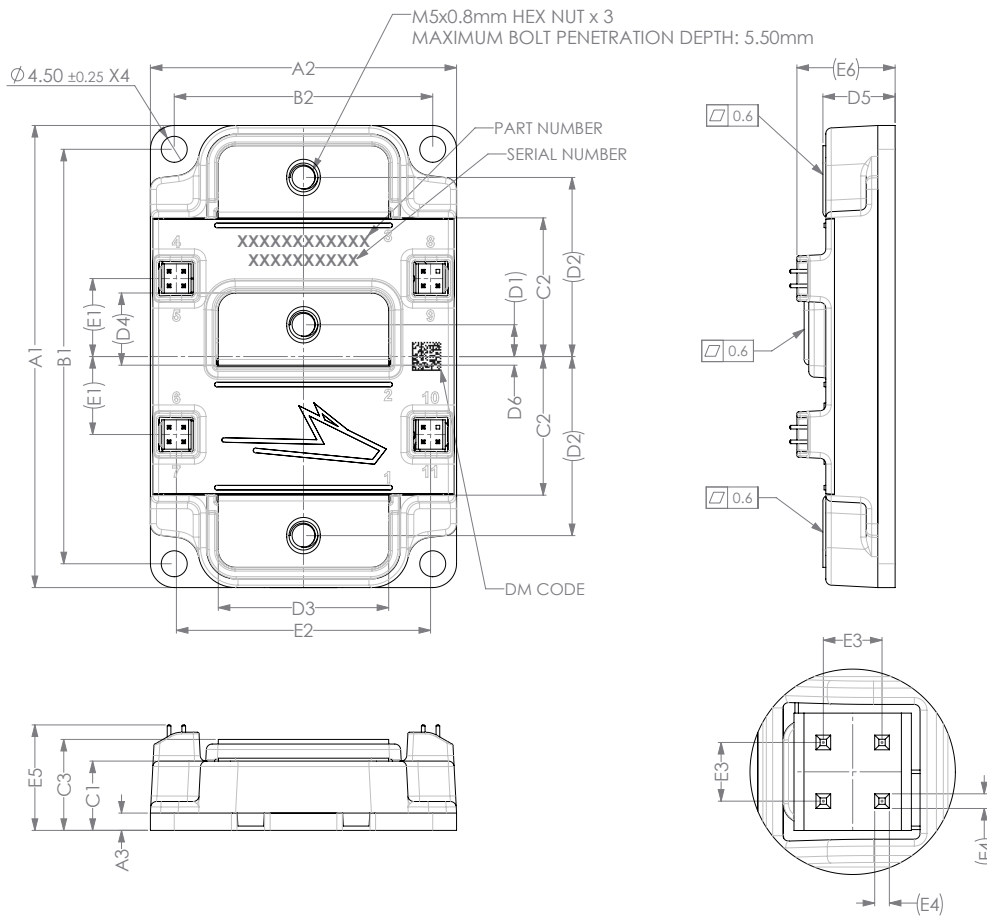

DIMENSION TABLE		
SYMBOL	DIMENSION (mm)	TOLERANCE (mm)
A1	80.00	±0.30
A2	53.00	±0.30
A3	3.00	±0.30
B1	71.75	±0.30
B2	44.75	±0.30
C1	12.00	±0.50
C2	24.00	±0.50
C3	15.75	±0.40
D1	(5.50)	REF.
D2	(31.00)	REF.
D3	29.50	±0.30
D4	(12.50) TYP	REF.
D5	12.50	±0.30
D6	1.50	±0.30
E1	(13.50)	REF.
E2	44.00	±0.30
E3	2.54	±0.50
E4	(0.64)	REF.
E5	18.26	±0.30
E6	(17.00)	REF.



Package Dimensions (mm)

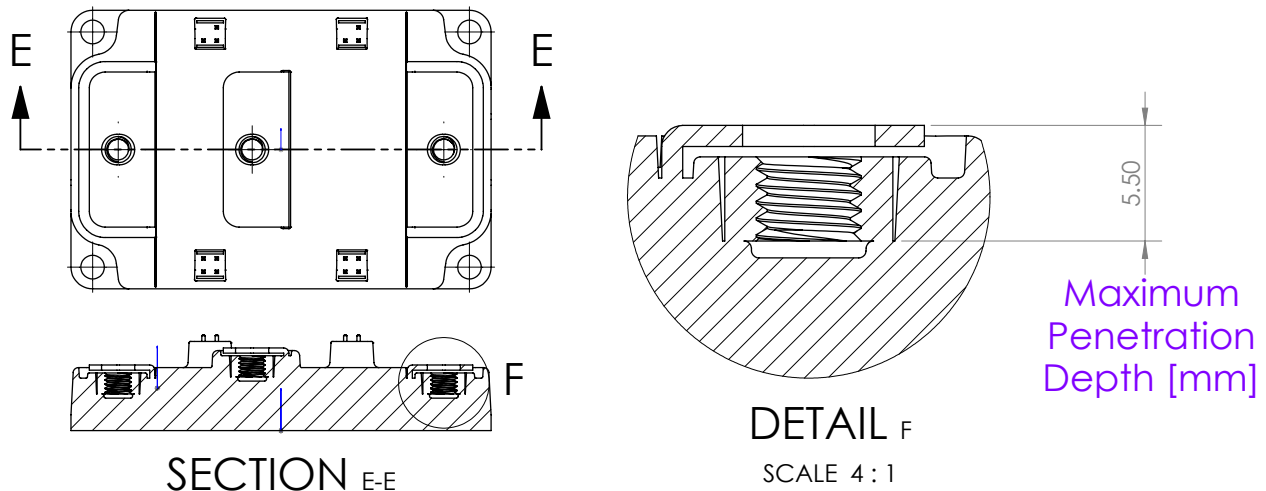

Supporting Links & Tools

Evaluation Tools & Support

- [All SiC Module PLECS Model](#)
- [All SiC Module LTspice Models](#)
- [KIT-CRD-CIL12N-XM3: Dynamic Performance Evaluation Board for the XM3 Module](#)
- [SpeedFit 2.0 Design Simulator™](#)
- [Technical Support Forum](#)

Dual-Channel Gate Driver Board

- [CGD12HBXMP: XM3 Evaluation Gate Driver](#)
- [CGD12HB00D: Differential Transceiver Daughter Board Companion Tool for Differential Gate Drivers](#)
- [FRDMGD3160XM3EVM: GD3160 XM3 Half-Bridge Evaluation Kit](#)
- [UCC5880QEVM-057 Evaluating Gate Driver for Wolfspeed XM3 Modules](#)
- [UCC5880INVERTEREVM Evaluating Board for Wolfspeed XM3 Modules](#)
- [Si828x Gate Driver Boards for Wolfspeed XM3 Modules](#)

Application Notes

- [XM Module Signal Pinout Clarification Guide](#)
- [XM Mounting Guide](#)
- [XM3 Thermal Interference Material Guide](#)
- [PRD-06832: Design Options for Wolfspeed® Silicon Carbide MOSFET Gate Bias Power Supplies](#)



Notes & Disclaimer

This document and the information contained herein are subject to change without notice. Any such change shall be evidenced by the publication of an updated version of this document by Wolfspeed. No communication from any employee or agent of Wolfspeed or any third party shall effect an amendment or modification of this document. No responsibility is assumed by Wolfspeed for any infringement of patents or other rights of third parties which may result from use of the information contained herein. No license is granted by implication or otherwise under any patent or patent rights of Wolfspeed.

Notwithstanding any application-specific information, guidance, assistance, or support that Wolfspeed may provide, the buyer of this product is solely responsible for determining the suitability of this product for the buyer's purposes, including without limitation for use in the applications identified in the next bullet point, and for the compliance of the buyers' products, including those that incorporate this product, with all applicable legal, regulatory, and safety-related requirements.

This product has not been designed or tested for use in, and is not intended for use in, applications in which failure of the product would reasonably be expected to cause death, personal injury, or property damage, including but not limited to equipment implanted into the human body, life-support machines, cardiac defibrillators, and similar emergency medical equipment, aircraft navigation, communication, and control systems, aircraft power and propulsion systems, air traffic control systems, and equipment used in the planning, construction, maintenance, or operation of nuclear facilities.

RoHS Compliance

The levels of RoHS restricted materials in this product are below the maximum concentration values (also referred to as the threshold limits) permitted for such substances, or are used in an exempted application, in accordance with EU Directive 2011/65/EC (RoHS2), as implemented January 2, 2013. RoHS Declarations for this product can be obtained from your Wolfspeed representative or from the Product Documentation sections of www.wolfspeed.com.

REACH Compliance

REACH substances of high concern (SVHCs) information is available for this product. Since the European Chemical Agency (ECHA) has published notice of their intent to frequently revise the SVHC listing for the foreseeable future, please contact your Wolfspeed representative to ensure you get the most up-to-date REACH SVHC Declaration. REACH banned substance information (REACH Article 67) is also available upon request.

Contact info:

4600 Silicon Drive
Durham, NC 27703 USA
Tel: +1.919.313.5300
www.wolfspeed.com/power